

Data sheet | Item number: 209-148

Multi mounting adapter; for male and female connectors with snap-in mounting feet

www.wago.com/209-148

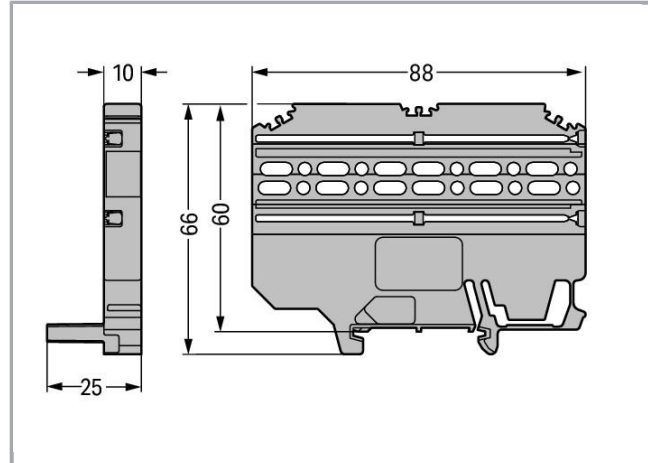
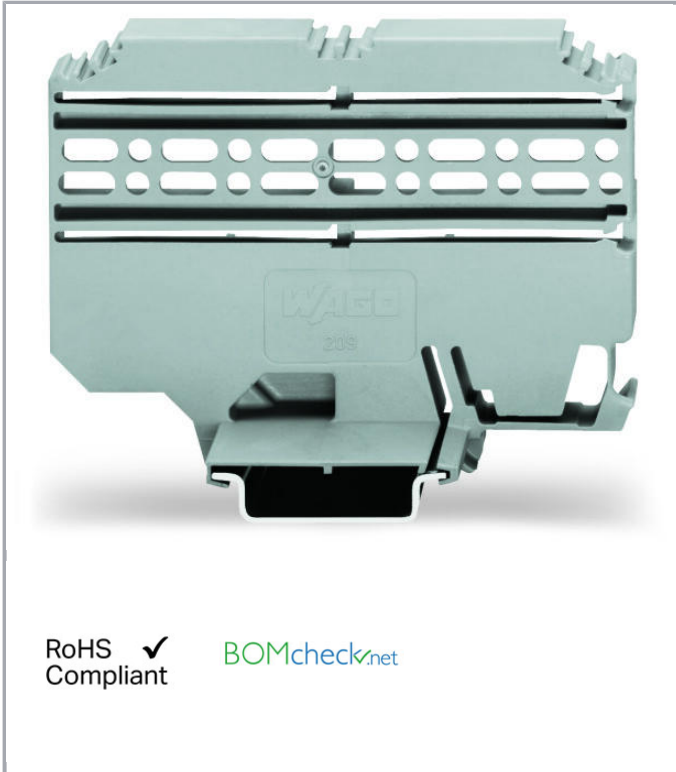

RoHS Compliant

BOMcheck.net

Data

Electrical data

Ratings per IEC/EN 60664-1

Legend (ratings)

(III / 2) $\hat{=}$ Overvoltage category III / Pollution degree 2

Approvals per UL 1059

Approvals per

UL 1059

Connection data

Number of connection types

1

Subject to changes. Please also observe the further product documentation!

WAGO Kontakttechnik GmbH & Co. KG
Hansastr. 27
32423 Minden
Phone: +49571 887-0 | Fax: +49571 887-169
Email: info.de@wago.com | Web: www.wago.com

Do you have any questions about our products?
We are always happy to take your call at +49 (571) 887-44222.

Geometrical Data

Width	25 mm / 0.984 inch
Height	60 mm / 2.362 inch
Depth	88 mm / 3.465 inch

Mechanical data

Mounting type	Snap-in mounting foot
Type of mounting	DIN-35 rail
Suitable	for male and female connectors with snap-in mounting feet

Material Data

Fire load	0.458 MJ
Weight	18.2 g

Commercial data

Product Group	2 (Terminal Block Accessories)
Packaging type	BOX
Country of origin	PL
GTIN	4017332968829
Customs Tariff No.	39269097900

Counterpart

Compatible products

Female plug



Item no.: 231-102/008-000

1-conductor female plug; Snap-in mounting feet; 2.5 mm²; Pin spacing 5 mm; 2-pole; 2,50 mm²; gray

www.wago.com/231-102/008-000



Item no.: 231-103/008-000

1-conductor female plug; Snap-in mounting feet; 2.5 mm²; Pin spacing 5 mm; 3-pole; 2,50 mm²; gray

www.wago.com/231-103/008-000

Item no.: 231-104/008-000

1-conductor female plug; Snap-in mounting feet; 2.5 mm²; Pin spacing 5 mm; 4-pole; 2,50 mm²; gray

www.wago.com/231-104/008-000

Subject to changes. Please also observe the further product documentation!

WAGO Kontakttechnik GmbH & Co. KG

Hansastr. 27

32423 Minden













Phone: +49571 887-0 | Fax: +49571 887-169

Email: info.de@wago.com | Web: www.wago.com

Do you have any questions about our products?

We are always happy to take your call at +49 (571) 887-44222.



	Item no.: 231-105/008-000 1-conductor female plug; Snap-in mounting feet; 2.5 mm ² ; Pin spacing 5 mm; 5-pole; 2,50 mm ² ; gray	www.wago.com/231-105/008-000
	Item no.: 231-106/008-000 1-conductor female plug; Snap-in mounting feet; 2.5 mm ² ; Pin spacing 5 mm; 6-pole; 2,50 mm ² ; gray	www.wago.com/231-106/008-000
	Item no.: 231-107/008-000 1-conductor female plug; Snap-in mounting feet; 2.5 mm ² ; Pin spacing 5 mm; 7-pole; 2,50 mm ² ; gray	www.wago.com/231-107/008-000
	Item no.: 231-108/008-000 1-conductor female plug; Snap-in mounting feet; 2.5 mm ² ; Pin spacing 5 mm; 8-pole; 2,50 mm ² ; gray	www.wago.com/231-108/008-000
	Item no.: 231-109/008-000 1-conductor female plug; Snap-in mounting feet; 2.5 mm ² ; Pin spacing 5 mm; 9-pole; 2,50 mm ² ; gray	www.wago.com/231-109/008-000
	Item no.: 231-110/008-000 1-conductor female plug; Snap-in mounting feet; 2.5 mm ² ; Pin spacing 5 mm; 10-pole; 2,50 mm ² ; gray	www.wago.com/231-110/008-000
	Item no.: 231-111/008-000 1-conductor female plug; Snap-in mounting feet; 2.5 mm ² ; Pin spacing 5 mm; 11-pole; 2,50 mm ² ; gray	www.wago.com/231-111/008-000
	Item no.: 231-112/008-000 1-conductor female plug; Snap-in mounting feet; 2.5 mm ² ; Pin spacing 5 mm; 12-pole; 2,50 mm ² ; gray	www.wago.com/231-112/008-000
	Item no.: 231-113/008-000 1-conductor female plug; Snap-in mounting feet; 2.5 mm ² ; Pin spacing 5 mm; 13-pole; 2,50 mm ² ; gray	www.wago.com/231-113/008-000
	Item no.: 231-114/008-000 1-conductor female plug; Snap-in mounting feet; 2.5 mm ² ; Pin spacing 5 mm; 14-pole; 2,50 mm ² ; gray	www.wago.com/231-114/008-000
	Item no.: 231-115/008-000 1-conductor female plug; Snap-in mounting feet; 2.5 mm ² ; Pin spacing 5 mm; 15-pole; 2,50 mm ² ; gray	www.wago.com/231-115/008-000
	Item no.: 231-116/008-000 1-conductor female plug; Snap-in mounting feet; 2.5 mm ² ; Pin spacing 5 mm; 16-pole; 2,50 mm ² ; gray	www.wago.com/231-116/008-000
	Item no.: 231-117/008-000 1-conductor female plug; Snap-in mounting feet; 2.5 mm ² ; Pin spacing 5 mm; 17-pole; 2,50 mm ² ; gray	www.wago.com/231-117/008-000

Subject to changes. Please also observe the further product documentation!

**Item no.: 231-118/008-000**1-conductor female plug; Snap-in mounting feet; 2.5 mm²; Pin spacing 5 mm; 18-pole; 2,50 mm²; graywww.wago.com/231-118/008-000**Item no.: 231-119/008-000**1-conductor female plug; Snap-in mounting feet; 2.5 mm²; Pin spacing 5 mm; 19-pole; 2,50 mm²; graywww.wago.com/231-119/008-000**Item no.: 231-120/008-000**1-conductor female plug; Snap-in mounting feet; 2.5 mm²; Pin spacing 5 mm; 20-pole; 2,50 mm²; graywww.wago.com/231-120/008-000**Item no.: 231-121/008-000**1-conductor female plug; Snap-in mounting feet; 2.5 mm²; Pin spacing 5 mm; 21-pole; 2,50 mm²; graywww.wago.com/231-121/008-000**Item no.: 231-122/008-000**1-conductor female plug; Snap-in mounting feet; 2.5 mm²; Pin spacing 5 mm; 22-pole; 2,50 mm²; graywww.wago.com/231-122/008-000**Item no.: 231-123/008-000**1-conductor female plug; Snap-in mounting feet; 2.5 mm²; Pin spacing 5 mm; 23-pole; 2,50 mm²; graywww.wago.com/231-123/008-000**Item no.: 231-124/008-000**1-conductor female plug; Snap-in mounting feet; 2.5 mm²; Pin spacing 5 mm; 24-pole; 2,50 mm²; graywww.wago.com/231-124/008-000**Item no.: 231-202/008-000**1-conductor female plug; Snap-in mounting feet; 2.5 mm²; Pin spacing 7.5 mm; 2-pole; 2,50 mm²; graywww.wago.com/231-202/008-000**Item no.: 231-203/008-000**1-conductor female plug; Snap-in mounting feet; 2.5 mm²; Pin spacing 7.5 mm; 3-pole; 2,50 mm²; graywww.wago.com/231-203/008-000**Item no.: 231-204/008-000**1-conductor female plug; Snap-in mounting feet; 2.5 mm²; Pin spacing 7.5 mm; 4-pole; 2,50 mm²; graywww.wago.com/231-204/008-000**Item no.: 231-205/008-000**1-conductor female plug; Snap-in mounting feet; 2.5 mm²; Pin spacing 7.5 mm; 5-pole; 2,50 mm²; graywww.wago.com/231-205/008-000**Item no.: 231-206/008-000**1-conductor female plug; Snap-in mounting feet; 2.5 mm²; Pin spacing 7.5 mm; 6-pole; 2,50 mm²; graywww.wago.com/231-206/008-000**Item no.: 231-207/008-000**1-conductor female plug; Snap-in mounting feet; 2.5 mm²; Pin spacing 7.5 mm; 7-pole; 2,50 mm²; graywww.wago.com/231-207/008-000

Subject to changes. Please also observe the further product documentation!

WAGO Kontakttechnik GmbH & Co. KG

Hansastr. 27

32423 Minden

Phone: +49571 887-0 | Fax: +49571 887-169

Email: info.de@wago.com | Web: www.wago.com

Do you have any questions about our products?

We are always happy to take your call at +49 (571) 887-44222.



Item no.: 231-208/008-000

1-conductor female plug; Snap-in mounting feet; 2.5 mm²; Pin spacing 7.5 mm; 8-pole; 2,50 mm²; gray

www.wago.com/231-208/008-000



Item no.: 231-209/008-000

1-conductor female plug; Snap-in mounting feet; 2.5 mm²; Pin spacing 7.5 mm; 9-pole; 2,50 mm²; gray

www.wago.com/231-209/008-000



Item no.: 231-210/008-000

1-conductor female plug; Snap-in mounting feet; 2.5 mm²; Pin spacing 7.5 mm; 10-pole; 2,50 mm²; gray

www.wago.com/231-210/008-000



Item no.: 231-211/008-000

1-conductor female plug; Snap-in mounting feet; 2.5 mm²; Pin spacing 7.5 mm; 11-pole; 2,50 mm²; gray

www.wago.com/231-211/008-000



Item no.: 231-212/008-000

1-conductor female plug; Snap-in mounting feet; 2.5 mm²; Pin spacing 7.5 mm; 12-pole; 2,50 mm²; gray

www.wago.com/231-212/008-000



Item no.: 231-213/008-000

1-conductor female plug; Snap-in mounting feet; 2.5 mm²; Pin spacing 7.5 mm; 13-pole; 2,50 mm²; gray

www.wago.com/231-213/008-000



Item no.: 231-216/008-000

1-conductor female plug; Snap-in mounting feet; 2.5 mm²; Pin spacing 7.5 mm; 16-pole; 2,50 mm²; gray

www.wago.com/231-216/008-000



Item no.: 231-302/008-000

1-conductor female plug; Snap-in mounting feet; 2.5 mm²; Pin spacing 5.08 mm; 2-pole; 2,50 mm²; orange

www.wago.com/231-302/008-000



Item no.: 231-303/008-000

1-conductor female plug; Snap-in mounting feet; 2.5 mm²; Pin spacing 5.08 mm; 3-pole; 2,50 mm²; orange

www.wago.com/231-303/008-000



Item no.: 231-304/008-000

1-conductor female plug; Snap-in mounting feet; 2.5 mm²; Pin spacing 5.08 mm; 4-pole; 2,50 mm²; orange

www.wago.com/231-304/008-000



Item no.: 231-305/008-000

1-conductor female plug; Snap-in mounting feet; 2.5 mm²; Pin spacing 5.08 mm; 5-pole; 2,50 mm²; orange

www.wago.com/231-305/008-000



Item no.: 231-306/008-000

1-conductor female plug; Snap-in mounting feet; 2.5 mm²; Pin spacing 5.08 mm; 6-pole; 2,50 mm²; orange

www.wago.com/231-306/008-000



Item no.: 231-307/008-000

1-conductor female plug; Snap-in mounting feet; 2.5 mm²; Pin spacing 5.08 mm; 7-pole; 2,50 mm²; orange

www.wago.com/231-307/008-000

Item no.: 231-308/008-000

Subject to changes. Please also observe the further product documentation!

WAGO Kontakttechnik GmbH & Co. KG

Hansastr. 27













32423 Minden

Phone: +49571 887-0 | Fax: +49571 887-169













Email: info.de@wago.com | Web: www.wago.com

Do you have any questions about our products?

We are always happy to take your call at +49 (571) 887-44222.













	1-conductor female plug; Snap-in mounting feet; 2.5 mm ² ; Pin spacing 5.08 mm; 8-pole; 2,50 mm ² ; orange	www.wago.com/231-308/008-000
	Item no.: 231-309/008-000 1-conductor female plug; Snap-in mounting feet; 2.5 mm ² ; Pin spacing 5.08 mm; 9-pole; 2,50 mm ² ; orange	www.wago.com/231-309/008-000
	Item no.: 231-310/008-000 1-conductor female plug; Snap-in mounting feet; 2.5 mm ² ; Pin spacing 5.08 mm; 10-pole; 2,50 mm ² ; orange	www.wago.com/231-310/008-000
	Item no.: 231-311/008-000 1-conductor female plug; Snap-in mounting feet; 2.5 mm ² ; Pin spacing 5.08 mm; 11-pole; 2,50 mm ² ; orange	www.wago.com/231-311/008-000
	Item no.: 231-312/008-000 1-conductor female plug; Snap-in mounting feet; 2.5 mm ² ; Pin spacing 5.08 mm; 12-pole; 2,50 mm ² ; orange	www.wago.com/231-312/008-000
	Item no.: 231-313/008-000 1-conductor female plug; Snap-in mounting feet; 2.5 mm ² ; Pin spacing 5.08 mm; 13-pole; 2,50 mm ² ; orange	www.wago.com/231-313/008-000
	Item no.: 231-314/008-000 1-conductor female plug; Snap-in mounting feet; 2.5 mm ² ; Pin spacing 5.08 mm; 14-pole; 2,50 mm ² ; orange	www.wago.com/231-314/008-000
	Item no.: 231-315/008-000 1-conductor female plug; Snap-in mounting feet; 2.5 mm ² ; Pin spacing 5.08 mm; 15-pole; 2,50 mm ² ; orange	www.wago.com/231-315/008-000
	Item no.: 231-316/008-000 1-conductor female plug; Snap-in mounting feet; 2.5 mm ² ; Pin spacing 5.08 mm; 16-pole; 2,50 mm ² ; orange	www.wago.com/231-316/008-000
	Item no.: 231-317/008-000 1-conductor female plug; Snap-in mounting feet; 2.5 mm ² ; Pin spacing 5.08 mm; 17-pole; 2,50 mm ² ; orange	www.wago.com/231-317/008-000
	Item no.: 231-318/008-000 1-conductor female plug; Snap-in mounting feet; 2.5 mm ² ; Pin spacing 5.08 mm; 18-pole; 2,50 mm ² ; orange	www.wago.com/231-318/008-000
	Item no.: 231-319/008-000 1-conductor female plug; Snap-in mounting feet; 2.5 mm ² ; Pin spacing 5.08 mm; 19-pole; 2,50 mm ² ; orange	www.wago.com/231-319/008-000
	Item no.: 231-320/008-000 1-conductor female plug; Snap-in mounting feet; 2.5 mm ² ; Pin spacing 5.08 mm; 20-pole; 2,50 mm ² ; orange	www.wago.com/231-320/008-000
	Item no.: 231-321/008-000	

Subject to changes. Please also observe the further product documentation!

	1-conductor female plug; Snap-in mounting feet; 2.5 mm ² ; Pin spacing 5.08 mm; 21-pole; 2,50 mm ² ; orange	www.wago.com/231-321/008-000
	Item no.: 231-322/008-000 1-conductor female plug; Snap-in mounting feet; 2.5 mm ² ; Pin spacing 5.08 mm; 22-pole; 2,50 mm ² ; orange	www.wago.com/231-322/008-000
	Item no.: 231-323/008-000 1-conductor female plug; Snap-in mounting feet; 2.5 mm ² ; Pin spacing 5.08 mm; 23-pole; 2,50 mm ² ; orange	www.wago.com/231-323/008-000
	Item no.: 231-324/008-000 1-conductor female plug; Snap-in mounting feet; 2.5 mm ² ; Pin spacing 5.08 mm; 24-pole; 2,50 mm ² ; orange	www.wago.com/231-324/008-000
	Item no.: 231-702/008-000 1-conductor female plug; Snap-in mounting feet; 2.5 mm ² ; Pin spacing 7.62 mm; 2-pole; 2,50 mm ² ; orange	www.wago.com/231-702/008-000
	Item no.: 231-703/008-000 1-conductor female plug; Snap-in mounting feet; 2.5 mm ² ; Pin spacing 7.62 mm; 3-pole; 2,50 mm ² ; orange	www.wago.com/231-703/008-000
	Item no.: 231-704/008-000 1-conductor female plug; Snap-in mounting feet; 2.5 mm ² ; Pin spacing 7.62 mm; 4-pole; 2,50 mm ² ; orange	www.wago.com/231-704/008-000
	Item no.: 231-705/008-000 1-conductor female plug; Snap-in mounting feet; 2.5 mm ² ; Pin spacing 7.62 mm; 5-pole; 2,50 mm ² ; orange	www.wago.com/231-705/008-000
	Item no.: 231-706/008-000 1-conductor female plug; Snap-in mounting feet; 2.5 mm ² ; Pin spacing 7.62 mm; 6-pole; 2,50 mm ² ; orange	www.wago.com/231-706/008-000
	Item no.: 231-707/008-000 1-conductor female plug; Snap-in mounting feet; 2.5 mm ² ; Pin spacing 7.62 mm; 7-pole; 2,50 mm ² ; orange	www.wago.com/231-707/008-000
	Item no.: 231-708/008-000 1-conductor female plug; Snap-in mounting feet; 2.5 mm ² ; Pin spacing 7.62 mm; 8-pole; 2,50 mm ² ; orange	www.wago.com/231-708/008-000
	Item no.: 231-709/008-000 1-conductor female plug; Snap-in mounting feet; 2.5 mm ² ; Pin spacing 7.62 mm; 9-pole; 2,50 mm ² ; orange	www.wago.com/231-709/008-000
	Item no.: 231-710/008-000 1-conductor female plug; Snap-in mounting feet; 2.5 mm ² ; Pin spacing 7.62 mm; 10-pole; 2,50 mm ² ; orange	www.wago.com/231-710/008-000

Item no.: 231-711/008-000

Subject to changes. Please also observe the further product documentation!

	1-conductor female plug; Snap-in mounting feet; 2.5 mm ² ; Pin spacing 7.62 mm; 11-pole; 2,50 mm ² ; orange	www.wago.com/231-711/008-000
	Item no.: 231-712/008-000 1-conductor female plug; Snap-in mounting feet; 2.5 mm ² ; Pin spacing 7.62 mm; 12-pole; 2,50 mm ² ; orange	www.wago.com/231-712/008-000
	Item no.: 721-102/008-000 1-conductor female plug; 100% protected against mismatching; Snap-in mounting feet; 2.5 mm ² ; Pin spacing 5 mm; 2-pole; 2,50 mm ² ; light gray	www.wago.com/721-102/008-000
	Item no.: 721-103/008-000 1-conductor female plug; 100% protected against mismatching; Snap-in mounting feet; 2.5 mm ² ; Pin spacing 5 mm; 3-pole; 2,50 mm ² ; light gray	www.wago.com/721-103/008-000
	Item no.: 721-104/008-000 1-conductor female plug; 100% protected against mismatching; Snap-in mounting feet; 2.5 mm ² ; Pin spacing 5 mm; 4-pole; 2,50 mm ² ; light gray	www.wago.com/721-104/008-000
	Item no.: 721-105/008-000 1-conductor female plug; 100% protected against mismatching; Snap-in mounting feet; 2.5 mm ² ; Pin spacing 5 mm; 5-pole; 2,50 mm ² ; light gray	www.wago.com/721-105/008-000
	Item no.: 721-106/008-000 1-conductor female plug; 100% protected against mismatching; Snap-in mounting feet; 2.5 mm ² ; Pin spacing 5 mm; 6-pole; 2,50 mm ² ; light gray	www.wago.com/721-106/008-000
	Item no.: 721-107/008-000 1-conductor female plug; 100% protected against mismatching; Snap-in mounting feet; 2.5 mm ² ; Pin spacing 5 mm; 7-pole; 2,50 mm ² ; light gray	www.wago.com/721-107/008-000
	Item no.: 721-108/008-000 1-conductor female plug; 100% protected against mismatching; Snap-in mounting feet; 2.5 mm ² ; Pin spacing 5 mm; 8-pole; 2,50 mm ² ; light gray	www.wago.com/721-108/008-000
	Item no.: 721-109/008-000 1-conductor female plug; 100% protected against mismatching; Snap-in mounting feet; 2.5 mm ² ; Pin spacing 5 mm; 9-pole; 2,50 mm ² ; light gray	www.wago.com/721-109/008-000
	Item no.: 721-110/008-000 1-conductor female plug; 100% protected against mismatching; Snap-in mounting feet; 2.5 mm ² ; Pin spacing 5 mm; 10-pole; 2,50 mm ² ; light gray	www.wago.com/721-110/008-000
	Item no.: 721-112/008-000 1-conductor female plug; 100% protected against mismatching; Snap-in mounting feet; 2.5 mm ² ; Pin spacing 5 mm; 12-pole; 2,50 mm ² ; light gray	www.wago.com/721-112/008-000
	Item no.: 721-114/008-000 1-conductor female plug; 100% protected against mismatching; Snap-in mounting feet; 2.5 mm ² ; Pin spacing 5 mm; 14-pole; 2,50 mm ² ; light gray	www.wago.com/721-114/008-000
	Item no.: 721-116/008-000	

Subject to changes. Please also observe the further product documentation!



1-conductor female plug; 100% protected against mismating; Snap-in mounting feet; 2.5 mm²; Pin spacing 5 mm; 16-pole; 2,50 mm²; light gray

www.wago.com/721-116/008-000



Item no.: 721-120/008-000

1-conductor female plug; 100% protected against mismating; Snap-in mounting feet; 2.5 mm²; Pin spacing 5 mm; 20-pole; 2,50 mm²; light gray

www.wago.com/721-120/008-000



Item no.: 721-202/008-000

1-conductor female plug; 100% protected against mismating; Snap-in mounting feet; 2.5 mm²; Pin spacing 7.5 mm; 2-pole; 2,50 mm²; light gray

www.wago.com/721-202/008-000



Item no.: 721-203/008-000

1-conductor female plug; 100% protected against mismating; Snap-in mounting feet; 2.5 mm²; Pin spacing 7.5 mm; 3-pole; 2,50 mm²; light gray

www.wago.com/721-203/008-000



Item no.: 721-204/008-000

1-conductor female plug; 100% protected against mismating; Snap-in mounting feet; 2.5 mm²; Pin spacing 7.5 mm; 4-pole; 2,50 mm²; light gray

www.wago.com/721-204/008-000



Item no.: 721-205/008-000

1-conductor female plug; 100% protected against mismating; Snap-in mounting feet; 2.5 mm²; Pin spacing 7.5 mm; 5-pole; 2,50 mm²; light gray

www.wago.com/721-205/008-000



Item no.: 721-206/008-000

1-conductor female plug; 100% protected against mismating; Snap-in mounting feet; 2.5 mm²; Pin spacing 7.5 mm; 6-pole; 2,50 mm²; light gray

www.wago.com/721-206/008-000



Item no.: 721-207/008-000

1-conductor female plug; 100% protected against mismating; Snap-in mounting feet; 2.5 mm²; Pin spacing 7.5 mm; 7-pole; 2,50 mm²; light gray

www.wago.com/721-207/008-000



Item no.: 721-208/008-000

1-conductor female plug; 100% protected against mismating; Snap-in mounting feet; 2.5 mm²; Pin spacing 7.5 mm; 8-pole; 2,50 mm²; light gray

www.wago.com/721-208/008-000



Item no.: 721-209/008-000

1-conductor female plug; 100% protected against mismating; Snap-in mounting feet; 2.5 mm²; Pin spacing 7.5 mm; 9-pole; 2,50 mm²; light gray

www.wago.com/721-209/008-000



Item no.: 721-210/008-000

1-conductor female plug; 100% protected against mismating; Snap-in mounting feet; 2.5 mm²; Pin spacing 7.5 mm; 10-pole; 2,50 mm²; light gray

www.wago.com/721-210/008-000



Item no.: 721-211/008-000

1-conductor female plug; 100% protected against mismating; Snap-in mounting feet; 2.5 mm²; Pin spacing 7.5 mm; 11-pole; 2,50 mm²; light gray

www.wago.com/721-211/008-000















Item no.: 721-212/008-000

1-conductor female plug; 100% protected against mismating; Snap-in mounting feet; 2.5 mm²; Pin spacing 7.5 mm; 12-pole; 2,50 mm²; light gray

www.wago.com/721-212/008-000

Item no.: 721-302/008-000

Subject to changes. Please also observe the further product documentation!

	1-conductor female plug; angled; 100% protected against mismatching; Snap-in mounting feet; 2.5 mm ² ; Pin spacing 5 mm; 2-pole; 2,50 mm ² ; light gray	www.wago.com/721-302/008-000
	Item no.: 721-303/008-000 1-conductor female plug; angled; 100% protected against mismatching; Snap-in mounting feet; 2.5 mm ² ; Pin spacing 5 mm; 3-pole; 2,50 mm ² ; light gray	www.wago.com/721-303/008-000
	Item no.: 721-304/008-000 1-conductor female plug; angled; 100% protected against mismatching; Snap-in mounting feet; 2.5 mm ² ; Pin spacing 5 mm; 4-pole; 2,50 mm ² ; light gray	www.wago.com/721-304/008-000
	Item no.: 721-305/008-000 1-conductor female plug; angled; 100% protected against mismatching; Snap-in mounting feet; 2.5 mm ² ; Pin spacing 5 mm; 5-pole; 2,50 mm ² ; light gray	www.wago.com/721-305/008-000
	Item no.: 721-306/008-000 1-conductor female plug; angled; 100% protected against mismatching; Snap-in mounting feet; 2.5 mm ² ; Pin spacing 5 mm; 6-pole; 2,50 mm ² ; light gray	www.wago.com/721-306/008-000
	Item no.: 721-307/008-000 1-conductor female plug; angled; 100% protected against mismatching; Snap-in mounting feet; 2.5 mm ² ; Pin spacing 5 mm; 7-pole; 2,50 mm ² ; light gray	www.wago.com/721-307/008-000
	Item no.: 721-308/008-000 1-conductor female plug; angled; 100% protected against mismatching; Snap-in mounting feet; 2.5 mm ² ; Pin spacing 5 mm; 8-pole; 2,50 mm ² ; light gray	www.wago.com/721-308/008-000
	Item no.: 721-309/008-000 1-conductor female plug; angled; 100% protected against mismatching; Snap-in mounting feet; 2.5 mm ² ; Pin spacing 5 mm; 9-pole; 2,50 mm ² ; light gray	www.wago.com/721-309/008-000
	Item no.: 721-310/008-000 1-conductor female plug; angled; 100% protected against mismatching; Snap-in mounting feet; 2.5 mm ² ; Pin spacing 5 mm; 10-pole; 2,50 mm ² ; light gray	www.wago.com/721-310/008-000
	Item no.: 721-312/008-000 1-conductor female plug; angled; 100% protected against mismatching; Snap-in mounting feet; 2.5 mm ² ; Pin spacing 5 mm; 12-pole; 2,50 mm ² ; light gray	www.wago.com/721-312/008-000
	Item no.: 721-314/008-000 1-conductor female plug; angled; 100% protected against mismatching; Snap-in mounting feet; 2.5 mm ² ; Pin spacing 5 mm; 14-pole; 2,50 mm ² ; light gray	www.wago.com/721-314/008-000
	Item no.: 721-316/008-000 1-conductor female plug; angled; 100% protected against mismatching; Snap-in mounting feet; 2.5 mm ² ; Pin spacing 5 mm; 16-pole; 2,50 mm ² ; light gray	www.wago.com/721-316/008-000
	Item no.: 721-320/008-000 1-conductor female plug; angled; 100% protected against mismatching; Snap-in mounting feet; 2.5 mm ² ; Pin spacing 5 mm; 20-pole; 2,50 mm ² ; light gray	www.wago.com/721-320/008-000

Item no.: 731-502/008-000

Subject to changes. Please also observe the further product documentation!



1-conductor female plug; angled; Snap-in mounting feet; 2.5 mm²; Pin spacing 5 mm; 2-pole; 2,50 mm²; gray; www.wago.com/731-502/008-000



Item no.: 731-504/008-000
1-conductor female plug; angled; Snap-in mounting feet; 2.5 mm²; Pin spacing 5 mm; 4-pole; 2,50 mm²; gray; www.wago.com/731-504/008-000



Item no.: 731-505/008-000
1-conductor female plug; angled; Snap-in mounting feet; 2.5 mm²; Pin spacing 5 mm; 5-pole; 2,50 mm²; gray; www.wago.com/731-505/008-000



Item no.: 731-506/008-000
1-conductor female plug; angled; Snap-in mounting feet; 2.5 mm²; Pin spacing 5 mm; 6-pole; 2,50 mm²; gray; www.wago.com/731-506/008-000



Item no.: 731-507/008-000
1-conductor female plug; angled; Snap-in mounting feet; 2.5 mm²; Pin spacing 5 mm; 7-pole; 2,50 mm²; gray; www.wago.com/731-507/008-000



Item no.: 731-508/008-000
1-conductor female plug; angled; Snap-in mounting feet; 2.5 mm²; Pin spacing 5 mm; 8-pole; 2,50 mm²; gray; www.wago.com/731-508/008-000



Item no.: 731-510/008-000
1-conductor female plug; angled; Snap-in mounting feet; 2.5 mm²; Pin spacing 5 mm; 10-pole; 2,50 mm²; gray; www.wago.com/731-510/008-000



Item no.: 731-512/008-000
1-conductor female plug; angled; Snap-in mounting feet; 2.5 mm²; Pin spacing 5 mm; 12-pole; 2,50 mm²; gray; www.wago.com/731-512/008-000



Item no.: 731-513/008-000
1-conductor female plug; angled; Snap-in mounting feet; 2.5 mm²; Pin spacing 5 mm; 13-pole; 2,50 mm²; gray; www.wago.com/731-513/008-000



Item no.: 731-517/008-000
1-conductor female plug; angled; Snap-in mounting feet; 2.5 mm²; Pin spacing 5 mm; 17-pole; 2,50 mm²; gray; www.wago.com/731-517/008-000



Item no.: 731-518/008-000
1-conductor female plug; angled; Snap-in mounting feet; 2.5 mm²; Pin spacing 5 mm; 18-pole; 2,50 mm²; gray; www.wago.com/731-518/008-000















Item no.: 731-519/008-000
1-conductor female plug; angled; Snap-in mounting feet; 2.5 mm²; Pin spacing 5 mm; 19-pole; 2,50 mm²; gray; www.wago.com/731-519/008-000



Item no.: 731-520/008-000
1-conductor female plug; angled; Snap-in mounting feet; 2.5 mm²; Pin spacing 5 mm; 20-pole; 2,50 mm²; gray; www.wago.com/731-520/008-000

Item no.: 731-532/008-000

Subject to changes. Please also observe the further product documentation!













	1-conductor female plug; angled; Snap-in mounting feet; 2.5 mm ² ; Pin spacing 7.5 mm; 2-pole; 2,50 mm ² ; gray	www.wago.com/731-532/008-000
	Item no.: 731-533/008-000 1-conductor female plug; angled; Snap-in mounting feet; 2.5 mm ² ; Pin spacing 7.5 mm; 3-pole; 2,50 mm ² ; gray	www.wago.com/731-533/008-000
	Item no.: 731-534/008-000 1-conductor female plug; angled; Snap-in mounting feet; 2.5 mm ² ; Pin spacing 7.5 mm; 4-pole; 2,50 mm ² ; gray	www.wago.com/731-534/008-000
	Item no.: 731-535/008-000 1-conductor female plug; angled; Snap-in mounting feet; 2.5 mm ² ; Pin spacing 7.5 mm; 5-pole; 2,50 mm ² ; gray	www.wago.com/731-535/008-000
	Item no.: 731-536/008-000 1-conductor female plug; angled; Snap-in mounting feet; 2.5 mm ² ; Pin spacing 7.5 mm; 6-pole; 2,50 mm ² ; gray	www.wago.com/731-536/008-000
	Item no.: 731-537/008-000 1-conductor female plug; angled; Snap-in mounting feet; 2.5 mm ² ; Pin spacing 7.5 mm; 7-pole; 2,50 mm ² ; gray	www.wago.com/731-537/008-000
	Item no.: 731-538/008-000 1-conductor female plug; angled; Snap-in mounting feet; 2.5 mm ² ; Pin spacing 7.5 mm; 8-pole; 2,50 mm ² ; gray	www.wago.com/731-538/008-000
	Item no.: 731-539/008-000 1-conductor female plug; angled; Snap-in mounting feet; 2.5 mm ² ; Pin spacing 7.5 mm; 9-pole; 2,50 mm ² ; gray	www.wago.com/731-539/008-000
	Item no.: 731-540/008-000 1-conductor female plug; angled; Snap-in mounting feet; 2.5 mm ² ; Pin spacing 7.5 mm; 10-pole; 2,50 mm ² ; gray	www.wago.com/731-540/008-000
	Item no.: 731-541/008-000 1-conductor female plug; angled; Snap-in mounting feet; 2.5 mm ² ; Pin spacing 7.5 mm; 11-pole; 2,50 mm ² ; gray	www.wago.com/731-541/008-000
	Item no.: 731-542/008-000 1-conductor female plug; angled; Snap-in mounting feet; 2.5 mm ² ; Pin spacing 7.5 mm; 12-pole; 2,50 mm ² ; gray	www.wago.com/731-542/008-000
	Item no.: 731-543/008-000 1-conductor female plug; angled; Snap-in mounting feet; 2.5 mm ² ; Pin spacing 7.5 mm; 13-pole; 2,50 mm ² ; gray	www.wago.com/731-543/008-000
	Item no.: 731-546/008-000 1-conductor female plug; angled; Snap-in mounting feet; 2.5 mm ² ; Pin spacing 7.5 mm; 16-pole; 2,50 mm ² ; gray	www.wago.com/731-546/008-000

General accessories

Subject to changes. Please also observe the further product documentation!

WAGO Kontakttechnik GmbH & Co. KG
 Hansastr. 27
 32423 Minden
 Phone: +49571 887-0 | Fax: +49571 887-169
 Email: info.de@wago.com | Web: www.wago.com

Do you have any questions about our products?
 We are always happy to take your call at +49 (571) 887-44222.

	<p>Item no.: 231-602/018-000 1-conductor male connector; Snap-in mounting feet; 2.5 mm²; Pin spacing 5 mm; 2-pole; 2,50 mm²; gray</p>	www.wago.com/231-602/018-000
	<p>Item no.: 231-603/018-000 1-conductor male connector; Snap-in mounting feet; 2.5 mm²; Pin spacing 5 mm; 3-pole; 2,50 mm²; gray</p>	www.wago.com/231-603/018-000
	<p>Item no.: 231-604/018-000 1-conductor male connector; Snap-in mounting feet; 2.5 mm²; Pin spacing 5 mm; 4-pole; 2,50 mm²; gray</p>	www.wago.com/231-604/018-000
	<p>Item no.: 231-605/018-000 1-conductor male connector; Snap-in mounting feet; 2.5 mm²; Pin spacing 5 mm; 5-pole; 2,50 mm²; gray</p>	www.wago.com/231-605/018-000
	<p>Item no.: 231-606/018-000 1-conductor male connector; Snap-in mounting feet; 2.5 mm²; Pin spacing 5 mm; 6-pole; 2,50 mm²; gray</p>	www.wago.com/231-606/018-000
	<p>Item no.: 231-607/018-000 1-conductor male connector; Snap-in mounting feet; 2.5 mm²; Pin spacing 5 mm; 7-pole; 2,50 mm²; gray</p>	www.wago.com/231-607/018-000
	<p>Item no.: 231-608/018-000 1-conductor male connector; Snap-in mounting feet; 2.5 mm²; Pin spacing 5 mm; 8-pole; 2,50 mm²; gray</p>	www.wago.com/231-608/018-000
	<p>Item no.: 231-609/018-000 1-conductor male connector; Snap-in mounting feet; 2.5 mm²; Pin spacing 5 mm; 9-pole; 2,50 mm²; gray</p>	www.wago.com/231-609/018-000
	<p>Item no.: 231-610/018-000 1-conductor male connector; Snap-in mounting feet; 2.5 mm²; Pin spacing 5 mm; 10-pole; 2,50 mm²; gray</p>	www.wago.com/231-610/018-000
	<p>Item no.: 231-611/018-000 1-conductor male connector; Snap-in mounting feet; 2.5 mm²; Pin spacing 5 mm; 11-pole; 2,50 mm²; gray</p>	www.wago.com/231-611/018-000
	<p>Item no.: 231-612/018-000 1-conductor male connector; Snap-in mounting feet; 2.5 mm²; Pin spacing 5 mm; 12-pole; 2,50 mm²; gray</p>	www.wago.com/231-612/018-000
	<p>Item no.: 231-613/018-000 1-conductor male connector; Snap-in mounting feet; 2.5 mm²; Pin spacing 5 mm; 13-pole; 2,50 mm²; gray</p>	www.wago.com/231-613/018-000
	<p>Item no.: 231-614/018-000 1-conductor male connector; Snap-in mounting feet; 2.5 mm²; Pin spacing 5 mm; 14-pole; 2,50 mm²; gray</p>	www.wago.com/231-614/018-000

Item no.: 231-615/018-000

Subject to changes. Please also observe the further product documentation!



1-conductor male connector; Snap-in mounting feet; 2.5 mm²; Pin spacing 5 mm; 15-pole; 2,50 mm²; gray

www.wago.com/231-615/018-000



Item no.: 231-616/018-000

1-conductor male connector; Snap-in mounting feet; 2.5 mm²; Pin spacing 5 mm; 16-pole; 2,50 mm²; gray

www.wago.com/231-616/018-000



Item no.: 231-617/018-000

1-conductor male connector; Snap-in mounting feet; 2.5 mm²; Pin spacing 5 mm; 17-pole; 2,50 mm²; gray

www.wago.com/231-617/018-000



Item no.: 231-632/018-000

1-conductor male connector; Snap-in mounting feet; 2.5 mm²; Pin spacing 5.08 mm; 2-pole; 2,50 mm²; orange

www.wago.com/231-632/018-000



Item no.: 231-633/018-000

1-conductor male connector; Snap-in mounting feet; 2.5 mm²; Pin spacing 5.08 mm; 3-pole; 2,50 mm²; orange

www.wago.com/231-633/018-000



Item no.: 231-634/018-000

1-conductor male connector; Snap-in mounting feet; 2.5 mm²; Pin spacing 5.08 mm; 4-pole; 2,50 mm²; orange

www.wago.com/231-634/018-000



Item no.: 231-635/018-000

1-conductor male connector; Snap-in mounting feet; 2.5 mm²; Pin spacing 5.08 mm; 5-pole; 2,50 mm²; orange

www.wago.com/231-635/018-000



Item no.: 231-636/018-000

1-conductor male connector; Snap-in mounting feet; 2.5 mm²; Pin spacing 5.08 mm; 6-pole; 2,50 mm²; orange

www.wago.com/231-636/018-000



Item no.: 231-637/018-000

1-conductor male connector; Snap-in mounting feet; 2.5 mm²; Pin spacing 5.08 mm; 7-pole; 2,50 mm²; orange

www.wago.com/231-637/018-000



Item no.: 231-638/018-000

1-conductor male connector; Snap-in mounting feet; 2.5 mm²; Pin spacing 5.08 mm; 8-pole; 2,50 mm²; orange

www.wago.com/231-638/018-000



Item no.: 231-639/018-000

1-conductor male connector; Snap-in mounting feet; 2.5 mm²; Pin spacing 5.08 mm; 9-pole; 2,50 mm²; orange

www.wago.com/231-639/018-000



Item no.: 231-640/018-000

1-conductor male connector; Snap-in mounting feet; 2.5 mm²; Pin spacing 5.08 mm; 10-pole; 2,50 mm²; orange

www.wago.com/231-640/018-000



Item no.: 231-641/018-000

1-conductor male connector; Snap-in mounting feet; 2.5 mm²; Pin spacing 5.08 mm; 11-pole; 2,50 mm²; orange

www.wago.com/231-641/018-000

Item no.: 231-642/018-000

Subject to changes. Please also observe the further product documentation!



1-conductor male connector; Snap-in mounting feet; 2.5 mm²; Pin spacing 5.08 mm; 12-pole; 2,50 mm²; orange

www.wago.com/231-642/018-000



Item no.: 231-643/018-000

1-conductor male connector; Snap-in mounting feet; 2.5 mm²; Pin spacing 5.08 mm; 13-pole; 2,50 mm²; orange

www.wago.com/231-643/018-000



Item no.: 231-644/018-000

1-conductor male connector; Snap-in mounting feet; 2.5 mm²; Pin spacing 5.08 mm; 14-pole; 2,50 mm²; orange

www.wago.com/231-644/018-000



Item no.: 231-645/018-000

1-conductor male connector; Snap-in mounting feet; 2.5 mm²; Pin spacing 5.08 mm; 15-pole; 2,50 mm²; orange

www.wago.com/231-645/018-000



Item no.: 231-646/018-000

1-conductor male connector; Snap-in mounting feet; 2.5 mm²; Pin spacing 5.08 mm; 16-pole; 2,50 mm²; orange

www.wago.com/231-646/018-000

shield connection



Item no.: 790-108

Shield clamping saddle; 11 mm wide; diameter of compatible conductor; 3 ... 8 mm

www.wago.com/790-108

Downloads

Documentation

Additional Information

Technical explanations	Apr 3, 2019	pdf 3.6 MB	Download
------------------------	-------------	---------------	----------

CAD/CAE-Data

CAD data

2D/3D Models 209-148	URL	Download
----------------------	-----	----------

CAE data

EPLAN Data Portal 209-148	URL	Download
---------------------------	-----	----------

WSCAD Universe 209-148	URL	Download
------------------------	-----	----------

Installation Notes

Application

Subject to changes. Please also observe the further product documentation!

WAGO Kontakttechnik GmbH & Co. KG
 Hansastr. 27
 32423 Minden
 Phone: +49571 887-0 | Fax: +49571 887-169
 Email: info.de@wago.com | Web: www.wago.com

Do you have any questions about our products?
 We are always happy to take your call at +49 (571) 887-44222.

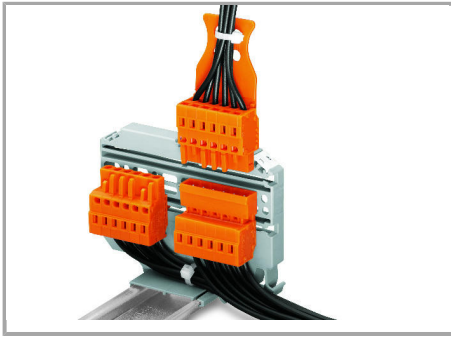

The pluggable male or female connector can also be fitted with a strain relief plate.

Installation

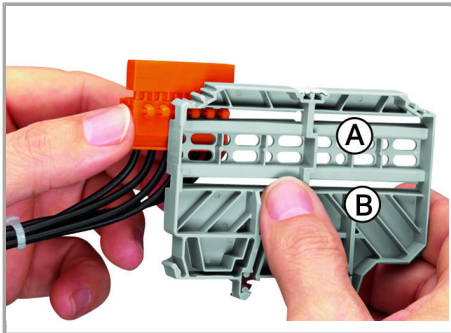

Both male and female connectors remain pluggable when they are mounted on the multi mounting adapter via its oblong holes or open grooves (A/B).

Subject to changes. Please also observe the further product documentation!