

Data sheet | Item number: 221-483

COMPACT Splicing Connector; for all conductor types; for Ex e applications;
max. 4 mm²; 3-conductor; with levers; transparent housing; Operating
temperature (max.): 105 °C; 4,00 mm²; transparent

www.wago.com/221-483

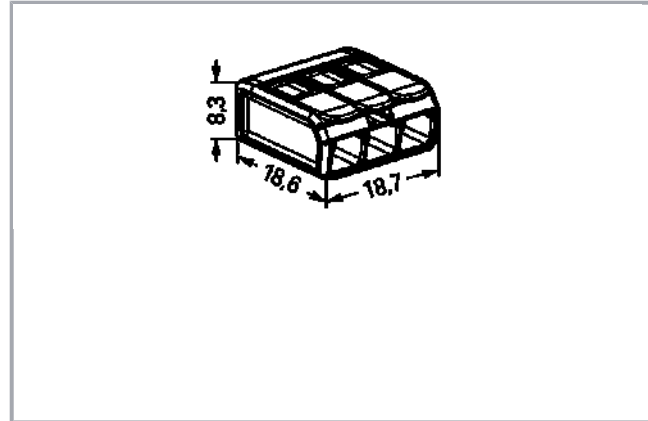

RoHS
Compliant

BOMcheck.net

Item description

Your Benefits:

- Ease of use – pull the lever up, insert a conductor and push the lever back down
- Available as 2-, 3- and 5-wire connectors
- Easily terminate conductors from 0.14 to 4 mm²
- Connect solid, stranded and fine-stranded conductors
- Time savings for installers and device manufacturers
- Quickly install devices with higher levels of power consumption
- Safely install long cable runs with larger conductor cross sections
- Mounting carrier for installation conforms to standards
- Working voltages of 275 V or 440 V
- Custom carriers are possible
- ATEX (Ex 2 II G), IECEx (Ex eb IIC Gb) Zone 1, 2
- IECEx (Ex eb IIC Gb), American Ex (AEx eb IICGb) / Class 1, Zone 1

Safety information 1:

Subject to changes. Please also observe the further product documentation!

WAGO Kontakttechnik GmbH & Co. KG
Hansastr. 27
32423 Minden
Phone: +49571 887-0 | Fax: +49571 887-169
Email: info.de@wago.com | Web: www.wago.com

Do you have any questions about our products?
We are always happy to take your call at +49 (571) 887-44222.



The permissible operating voltage of the connector with carrier (440 V or 275 V) depends on the mounting type.

Safety information 2:

Only approved in conjunction with a mounting carrier (221-501). Other carriers are possible, see certificate/file. The connectors must be installed in an enclosure meeting the requirements of a recognized protection type per EN 60079-0, Section 1 or EN 60079-31. When installing the connectors in an enclosure of protection type "eb" (increased safety) per EN 60079-7, the clearances and creepage distances of Table 2 for this standard must be observed. See point 1 for the use of accessories. The connectors can be used both in Group II and Group I, as the standard requirements are identical in this case.

The use of these components requires a new assessment by a notified certification agency.

Data

Electrical data

Ratings per IEC/EN 60664-1

Ratings per	IEC/EN 60079-7
-------------	----------------

Approvals per UL 1059

Rated voltage UL (Use Group C)	440 V
Rated current UL (Use Group C)	20 A
Approvals per	UL 60079

Approvals Ex

Rated voltage EN (Ex e II)	440 V
Rated current (Ex e II)	32 A

Connection data

Connection technology	CAGE CLAMP®
Actuation type	Lever
Connectable conductor materials	Copper
Nominal cross section	4 mm ²
Solid conductor	0,2 ... 4 mm ² / 24 ... 12 AWG
Stranded conductor	0,2 ... 4 mm ² / 24 ... 12 AWG
Fine-stranded conductor	0,14 ... 4 mm ² / 24 ... 12 AWG
Strip length	11 mm / 0.43 inch
Total number of connection points	3
Total number of potentials	1
Type of wiring	Side-entry wiring

Subject to changes. Please also observe the further product documentation!

Geometrical Data

Width	18,7 mm / 0.736 inch
Height	8,3 mm / 0.327 inch
Depth	18,6 mm / 0.732 inch

Material Data

Color	transparent
Flammability class per UL94	V2
Weight	2.7 g

Environmental Requirements



Continuous operating temperature	105 °C
----------------------------------	--------

Commercial data

Packaging type	BOX
Country of origin	DE
GTIN	4055143837347
Customs Tariff No.	85369010000

Approvals / Certificates

Ex-Approvals

Logo	Approval	Additional Approval Text	Certificate name
	AEx Underwriters Laboratories Inc.	UL 60079	20190228-E185892
	ATEX Physikalisch Technische Bundesanstalt	IEC 60079-0	PTB 18 ATEX 1019 U
	IECEX Physikalisch Technische Bundesanstalt	IEC 60079-0	IECEX PTB 18.0045U (Ex eb IIC Gb)



Country specific Approvals

Certificate

Subject to changes. Please also observe the further product documentation!

WAGO Kontakttechnik GmbH & Co. KG
 Hansastr. 27
 32423 Minden
 Phone: +49571 887-0 | Fax: +49571 887-169
 Email: info.de@wago.com | Web: www.wago.com



Do you have any questions about our products?
 We are always happy to take your call at +49 (571) 887-44222.

Logo	Approval	Additional Approval Text	name
	CCA DEKRA Certification B.V.	EN 60998	NTR NL-7642
	CCA DEKRA Certification B.V.	EN 60998	71-101731

Counterpart

Compatible products

Mounting adapter

	Item no.: 221-500/000-006 Mounting carrier; 221 Series - 4 mm ² ; for DIN-35 rail mounting/screw mounting; blue	www.wago.com/221-500/000-006
	Item no.: 221-501 Mounting carrier; for Ex applications; 221 Series - 4 mm ² ; for DIN-35 rail mounting/screw mounting; light gray	www.wago.com/221-501

Downloads

Documentation

Bid Text

221-483 GAEB docx - Datei	May 21, 2019	docx 16.4 kB	Download
221-483 GAEB X81 - Datei	May 21, 2019	xml 4.2 kB	Download

Additional Information

Technical explanations	Apr 3, 2019	pdf 2.1 MB	Download
------------------------	-------------	---------------	----------

System Description

System Description 221-482, 221-483, 221-485 System Description 221-482, 221-483, 221-485		pdf 1.2 MB	Download
--	--	---------------	----------

Subject to changes. Please also observe the further product documentation!

Installation Notes

Conductor termination

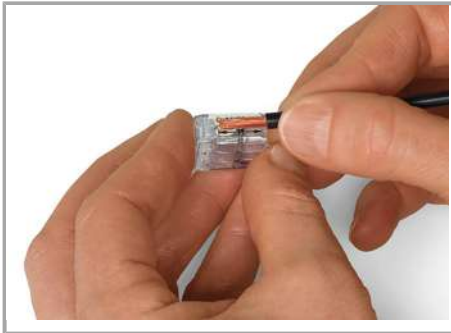

Strip conductor to 11 mm (0.43 inch).

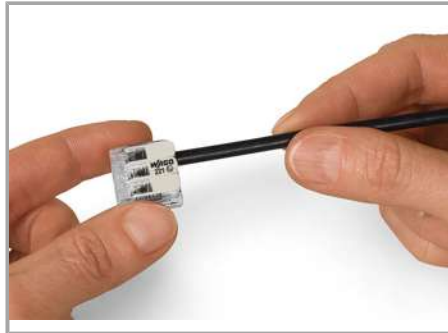

Then, lower the lever to close the clamp.

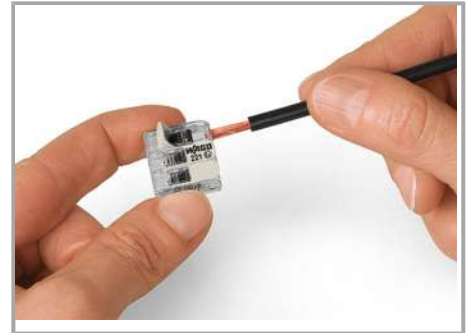

Termination: Lift the lever to open the clamping unit and insert a stripped conductor.

Installation

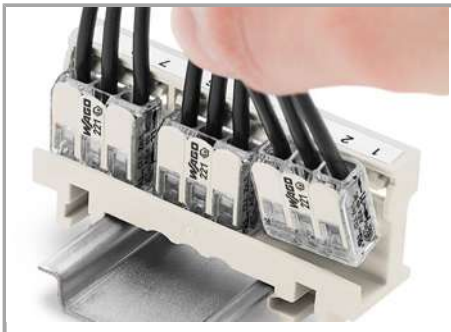

Inserting a connector into the mounting carrier.

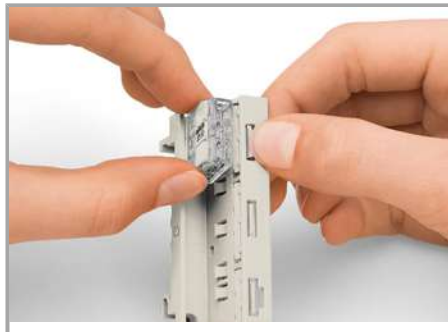

Removing a connector from the mounting carrier.



Removing a conductor.

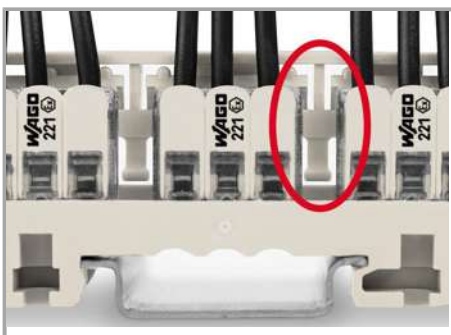

Mounting type (440 V)
Using spacers between the connectors.



Mounting type (440 V)
Vertical mounting on DIN-35 rail

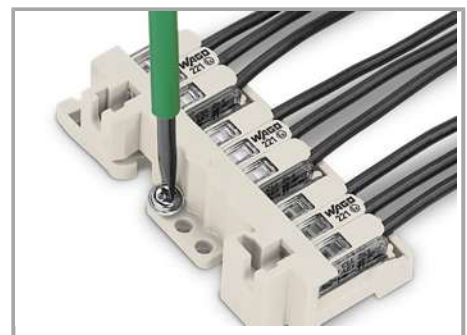

Mounting type (440 V)
Horizontal screw mounting on a flat surface

Subject to changes. Please also observe the further product documentation!

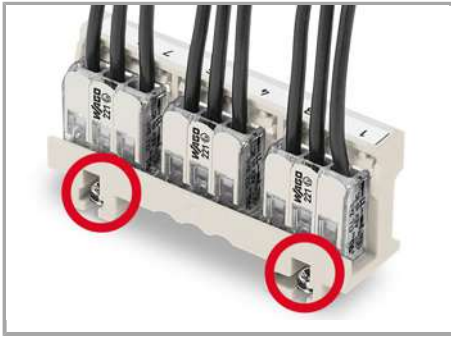

Mounting type (440 V)

Mounting the carrier via non-conductive screws.

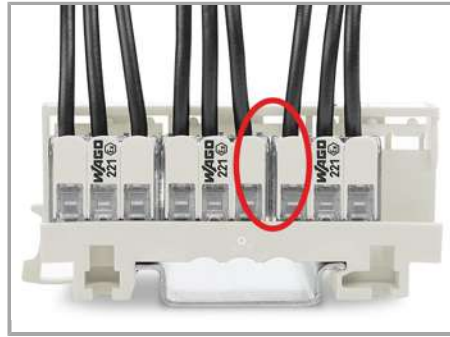

Mounting type (275 V)

No spacers are used between the connectors.

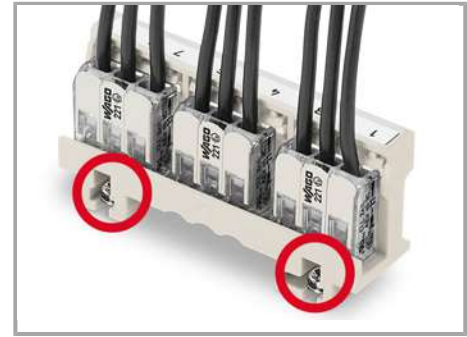

Mounting type (275 V)

Mounting the carrier using conductive screws.

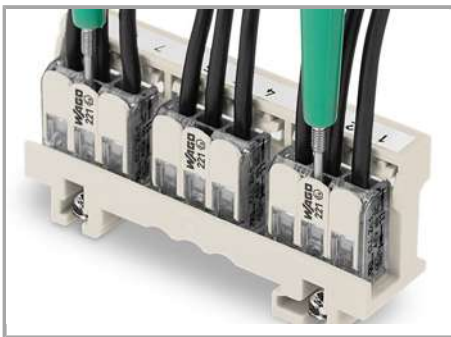

Easily test inserted connectors in the carrier
– without considering the type of mounting.

Subject to changes. Please also observe the further product documentation!