

Data sheet | Item number: 221-522/000-004

Mounting carrier; for 2-conductor terminal blocks; 221 Series - 4 mm²; with snap-in mounting foot for vertical mounting; black

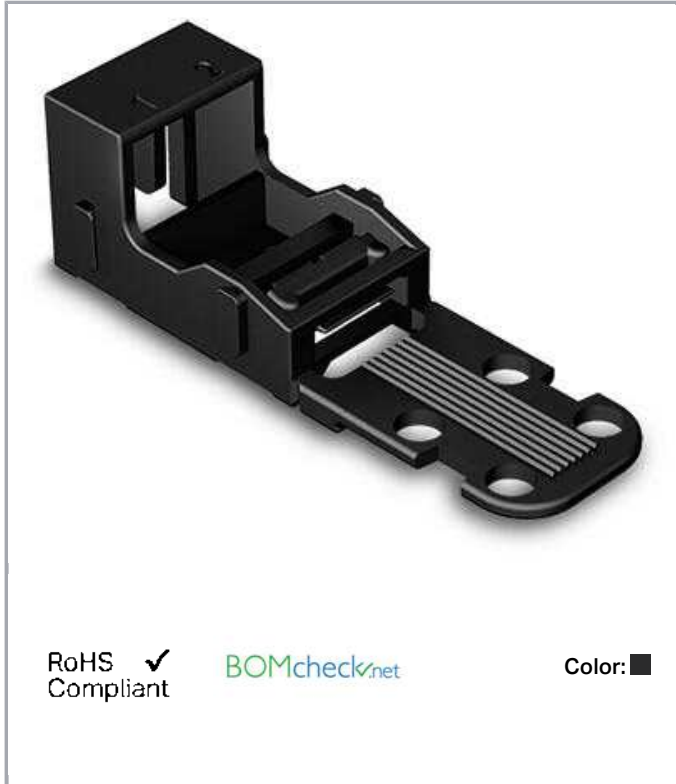

www.wago.com/221-522_000-004



RoHS
 Compliant

Color:

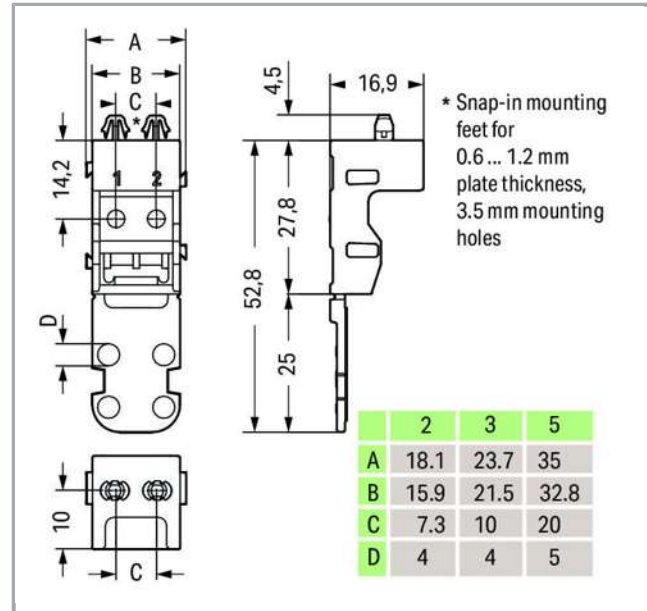

Data

Geometrical Data

Width	18.1 mm / 0.713 inch
Height	57.3 mm / 2.256 inch
Height from the surface	52.8 mm / 2.079 inch
Depth	16.9 mm / 0.665 inch

Material Data

Color	black
Insulating material	Polyamide 66 (PA 66)
Flammability class per UL94	V0
Weight	2.7 g

Subject to changes. Please also observe the further product documentation!

WAGO Kontakttechnik GmbH & Co. KG
Hansastr. 27
32423 Minden
Phone: +49571 887-0 | Fax: +49571 887-169
Email: info.de@wago.com | Web: www.wago.com

Do you have any questions about our products?
We are always happy to take your call at +49 (571) 887-44222.



Commercial data

Packaging type	BOX
Country of origin	CN
GTIN	4055143595889
Customs Tariff No.	39269097900

Counterpart

Downloads

Documentation

Bid Text

221-522/000-004 GAEB X81 - Datei	Feb 19, 2019	xml 2.8 kB	Download
221-522/000-004 doc - Datei	Jan 4, 2018	doc 24.6 kB	Download
Additional Information Technical explanations	Apr 3, 2019	pdf 2.1 MB	Download

CAD/CAE-Data

CAD data

2D/3D Models 221-522/000-004	URL	Download
------------------------------	-----	----------

Installation Notes

Subject to changes. Please also observe the further product documentation!

WAGO Kontakttechnik GmbH & Co. KG
 Hansastr. 27
 32423 Minden
 Phone: +49571 887-0 | Fax: +49571 887-169
 Email: info.de@wago.com | Web: www.wago.com

Do you have any questions about our products?
 We are always happy to take your call at +49 (571) 887-44222.

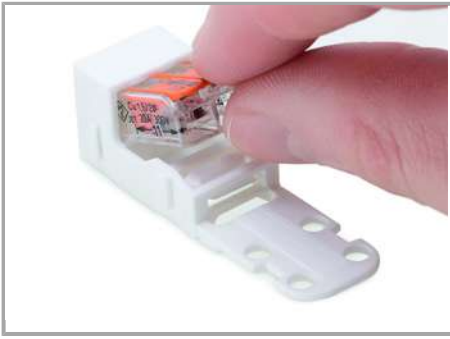

Inserting a connector into the mounting carrier.

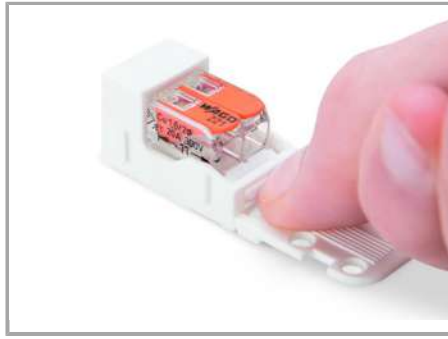

Removing a connector from the mounting carrier.

Inserting a conductor

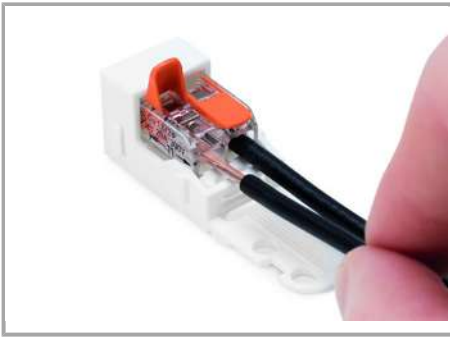

Inserting a conductor.

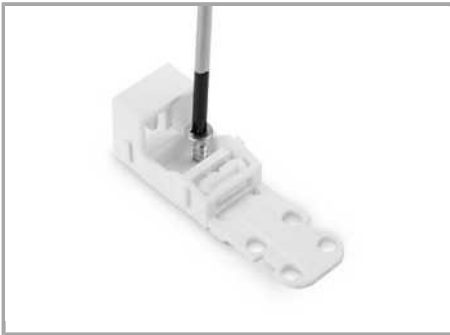

Horizontal screw mounting



Vertical screw mounting

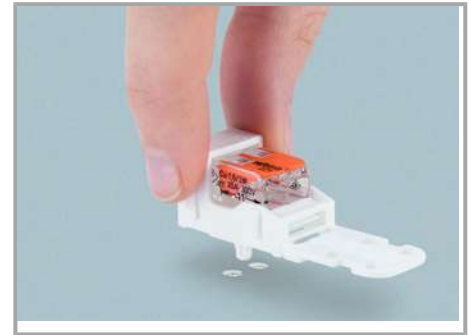

Horizontal mounting via snap-in foot

Subject to changes. Please also observe the further product documentation!



Vertical mounting via snap-in foot

Strain Relief



Use a cable tie to secure the conductors to the strain relief plate.



The strain relief plate can be removed.

Testing

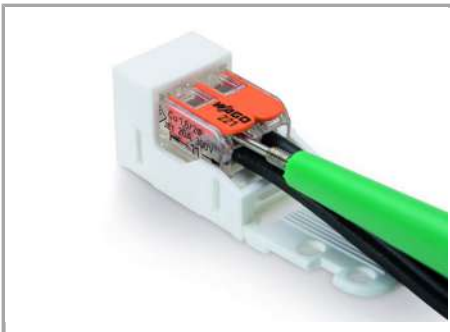

Testing a connector mounted on the carrier via test slot.

Application

Subject to changes. Please also observe the further product documentation!



Connecting a light to the mains.

Marking

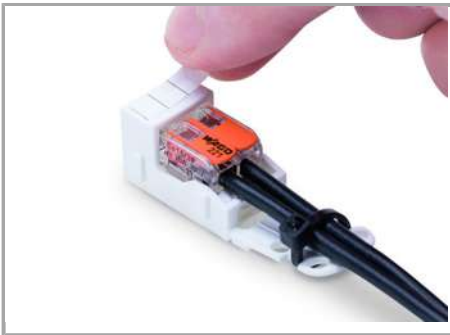

Labeling

Subject to changes. Please also observe the further product documentation!