

Data sheet | Item number: 231-161

Testing plug module with contact stud; for 236 Series; Pin spacing 7.5 mm / 0.295 in; gray

www.wago.com/231-161

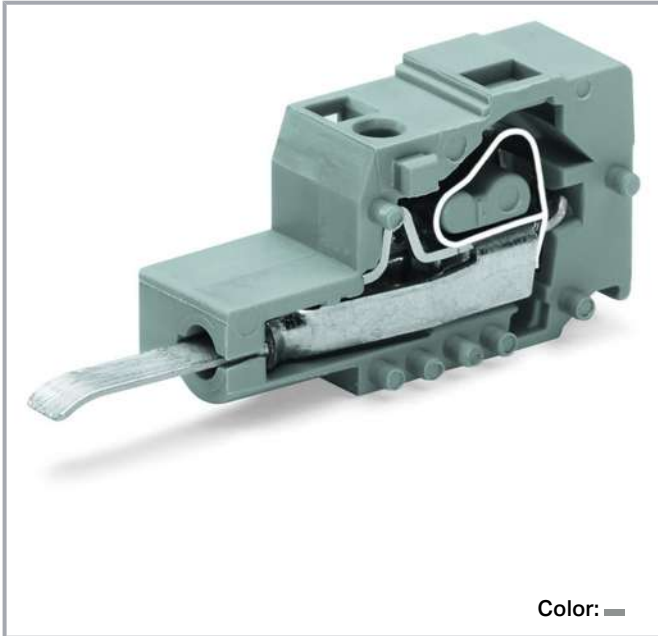

Dimensions in mm

L = pin spacing

Data
Electrical data

Subject to changes. Please also observe the further product documentation!

WAGO Corporation
Germantown, WI 53022
Phone: 1-800-DIN-RAIL (346-7245) | Fax: (262) 255-6222
Email: info.us@wago.com | Web: www.wago.us

Do you have any questions about our products?
We are always happy to take your call at +49 (571) 887-44222.



IEC Approvals

Ratings per	IEC/EN 60664-1
Rated voltage (III/2)	250 V
Rated surge voltage (III/2)	2.5 kV
Rated current	0.5 A
Legend (ratings)	(III / 2) ≙ Overvoltage category III / Pollution degree 2

Connection data

Total number of connection points	1
Total number of potentials	1
Number of connection types	1

Connection 1

Connection technology	CAGE CLAMP®
Solid conductor	0.08 ... 2.5 mm ² / 28 ... 12 AWG
Fine-stranded conductor	0.08 ... 2.5 mm ² / 28 ... 12 AWG
Strip length	12 ... 13 mm / 0.47 ... 0.51 inch

Physical data

Pin spacing	7.5 mm / 0.295 inch
Width	7.5 mm / 0.295 inch
Height	14.3 mm / 0.563 inch
Depth	36.45 mm / 1.435 inch

Mechanical data

Application	Testing without connected conductor
Test contact length	10 mm
Suitable	for 236 Series

Material data

Color	gray
Material group	I
Insulation material	Polyamide (PA66)
Flammability class per UL94	V0

Subject to changes. Please also observe the further product documentation!

Clamping spring material	Chrome nickel spring steel (CrNi)
Contact material	Electrolytic copper (E _{Cu})
Contact plating	tin-plated
Fire load	0.034 MJ
Weight	2.3 g

Environmental requirements

Limit temperature range	-60 ... +105 °C
-------------------------	-----------------

Commercial data

Product Group	3 (Multi Conn. System)
PU (SPU)	100 Stück
Packaging type	box
Country of origin	DE
GTIN	4045454193652
Customs tariff number	8536698000

Approvals / Certificates

Country specific Approvals

Logo	Approval	Additional Approval Text	Certificate name
	CSA DEKRA Certification B.V.	C22.2	1466354

Ship Approvals

Logo	Approval	Additional Approval Text	Certificate name
	LR Lloyds Register	IEC 61984	96/20035 (E5)

Required accessories

End plates

End plate	Item no.: 231-100
-----------	-------------------

Subject to changes. Please also observe the further product documentation!



End plate; 1.5 mm thick; gray

www.wago.com/231-100

Optional accessories

Tools

Operating tool

	Item no.: 210-657 Operating tool; Blade: 3.5 x 0.5 mm; with a partially insulated shaft; short; multicoloured	www.wago.com/210-657
	Item no.: 210-720 Operating tool; Blade: 3.5 x 0.5 mm; with a partially insulated shaft; multicoloured	www.wago.com/210-720

Downloads

Documentation

Additional Information

Technical explanations	2019 Apr 3	pdf 2.0 MB	Download
------------------------	------------	---------------	----------

CAD files

CAD data

2D/3D Models 231-161	URL	Download
----------------------	-----	----------

CAE data

ZUKEN Portal 231-161	URL	Download
----------------------	-----	----------

Environmental Product Compliance

Compliance Search

Environmental Product Compliance 231-161 Testing plug module with contact stud; for 236 Series; Pin spacing 7.5 mm / 0.295 in; gray	URL	Download
---	-----	----------

Installation Notes

Installation

Subject to changes. Please also observe the further product documentation!

WAGO Corporation
Germantown, WI 53022
Phone: 1-800-DIN-RAIL (346-7245) | Fax: (262) 255-6222
Email: info.us@wago.com | Web: www.wago.us

Do you have any questions about our products?
We are always happy to take your call at +49 (571) 887-44222.

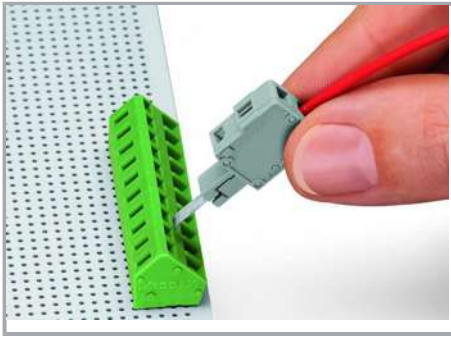

Inserting a test plug module into the operating slot.

Testing

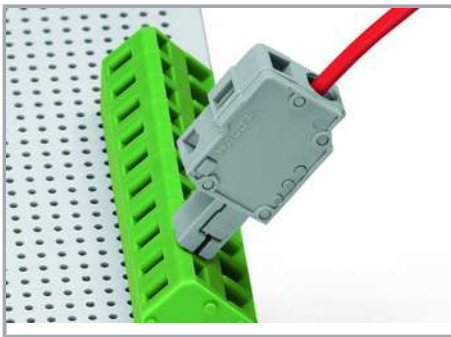

Unwired terminal strip with inserted test plug module

Application



Contact type A:

Testing only when unwired.

Subject to changes. Please also observe the further product documentation!