

# Data sheet | Item number: 231-233/001-000/105-604

Male header; 3-pole; THR; 1.0 x 1.0 mm solder pin; straight; pin spacing 7.5 mm; black

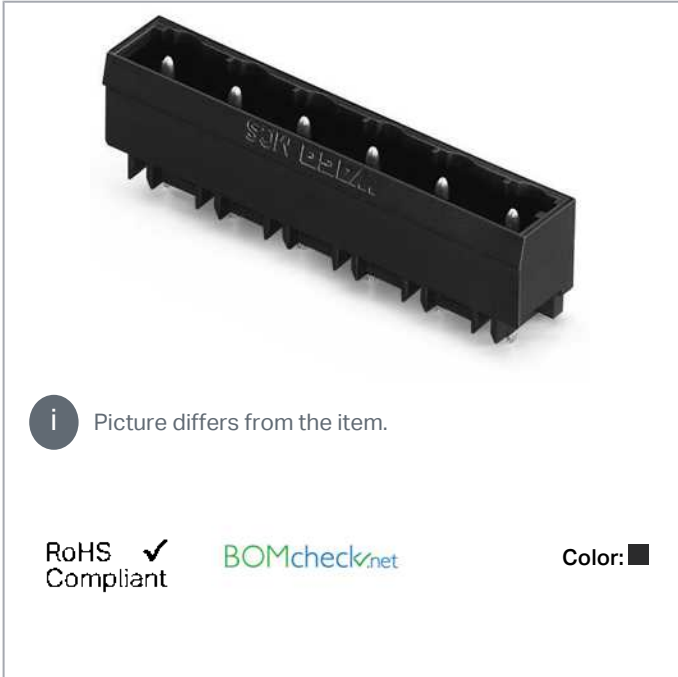

[www.wago.com/231-233\\_001-000\\_105-604](http://www.wago.com/231-233_001-000_105-604)



**i** Picture differs from the item.

RoHS  Compliant

BOMcheck.net

Color:

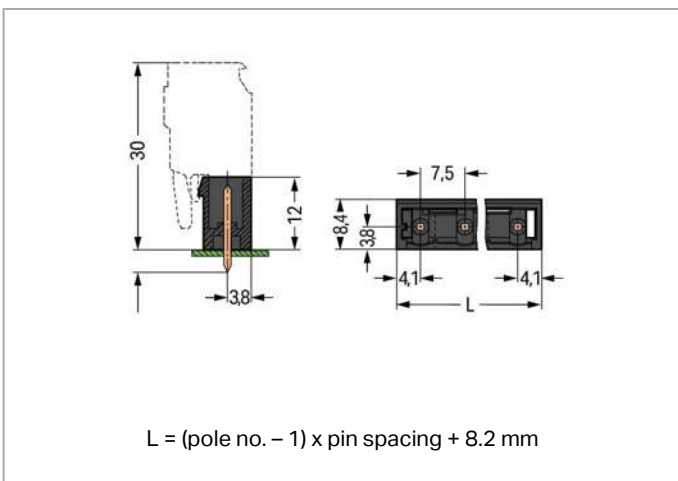
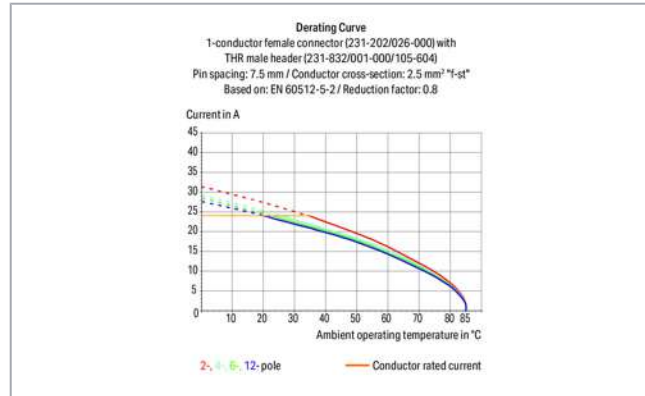

## Item description

- THR male headers for reflow soldering in SMT applications
- Available in tape-and-reel packaging for automated pick-and-place PCB assembly
- Also available in bulk packaging for manual placement

Subject to changes. Please also observe the further product documentation!

WAGO Corporation  
Germantown, WI 53022  
Phone: 1-800-DIN-RAIL (346-7245) | Fax: (262) 255-6222  
Email: [info.us@wago.com](mailto:info.us@wago.com) | Web: [www.wago.us](http://www.wago.us)

Do you have any questions about our products?  
We are always happy to take your call at {0}.



- Male headers may be mounted horizontally or vertically
- With coding fingers

**Safety information 1:**

The *MCS – MULTI CONNECTION SYSTEM* includes connectors without breaking capacity in accordance with DIN EN 61984. When used as intended, these connectors must not be connected/disconnected when live or under load. The circuit design should ensure header pins, which can be touched, are not live when unmated.

**Data****Electrical data****Ratings per IEC/EN 60664-1**

Ratings per	IEC/EN 60664-1
Rated voltage (III / 3)	500 V
Rated surge voltage (III/3)	6 kV
Rated voltage (III/2)	630 V
Rated surge voltage (III/2)	6 kV
Nominal voltage (II/2)	1000 V
Rated surge voltage (II/2)	6 kV
Rated current	12 A
Legend (ratings)	(III / 2) $\triangleq$ Overvoltage category III / Pollution degree 2

**Ratings per UL 1059**

Approvals per	UL 1059
Rated voltage UL (Use Group B)	300 V
Rated current UL (Use Group B)	10 A
Rated voltage UL (Use Group D)	300 V
Rated current UL (Use Group D)	10 A

**Ratings per UL 1977**

Rated voltage UL 1977	600 V
Rated current UL 1977	10 A

**Ratings per CSA**

Approvals per	CSA
Rated voltage CSA (Use Group B)	300 V
Rated current CSA (Use Group B)	10 A

Subject to changes. Please also observe the further product documentation!

WAGO Corporation  
 Germantown, WI 53022  
 Phone: 1-800-DIN-RAIL (346-7245) | Fax: (262) 255-6222  
 Email: [info.us@wago.com](mailto:info.us@wago.com) | Web: [www.wago.us](http://www.wago.us)

Do you have any questions about our products?  
 We are always happy to take your call at {0}.



Rated voltage CSA (Use Group D)	300 V
Rated current CSA (Use Group D)	10 A

### Connection data

Pole No.	3
Total number of potentials	3
Number of connection types	1
Number of levels	1

### Physical data

Pin spacing	7.5 mm / 0.295 inch
Width	23 mm / 0.906 inch
Height	14.4 mm / 0.567 inch
Height from the surface	12 mm / 0.472 inch
Depth	8.4 mm / 0.331 inch
Solder pin length	2.4 mm
Solder pin dimensions	1 x 1 mm
Plated through-hole diameter (THR)	1.4 <sup>(+0.1)</sup> mm

### Plug-in connection

Contact type (pluggable connector)	Male connector/plug
Connector (connection type)	for PCB
Mismating protection	No
Mating direction to the PCB	90°

### PCB contact

PCB contact	THR
Solder pin arrangement	over the entire male connector (in-line)
Number of solder pins per potential	1

### Material Data

Color	black
Material group	I
Insulation material	Polyphthalamide (PPA GF)
Flammability class per UL94	V0
Contact material	

Subject to changes. Please also observe the further product documentation!

	Electrolytic copper (E <sub>Cu</sub> )
Contact plating	tin-plated
Fire load	0.032 MJ
Weight	1.4 g

### Environmental Requirements



Limit temperature range	-60 ... +100 °C
-------------------------	-----------------

### Commercial data

Product Group	3 (Multi Conn. System)
Packaging type	BOX
Country of origin	PL
GTIN	4045454900847
Customs tariff number	85366990990

### Approvals / Certificates

#### Country specific Approvals

Logo	Approval	Additional Approval Text	Certificate name
	<b>CB</b> DEKRA Certification B.V.	IEC 61984	NL-39756
	<b>CSA</b> DEKRA Certification B.V.	C22.2	1466354
	<b>KEMA/KEUR</b> DEKRA Certification B.V.	EN 61984	2190761.01

#### Ship Approvals



Logo	Approval	Additional Approval Text	Certificate name
	<b>ABS</b> American Bureau of Shipping	-	19- HG1869876- PDA

#### UL-Approvals

Certificate

Subject to changes. Please also observe the further product documentation!



Logo	Approval	Additional Approval Text	name
	UR Underwriters Laboratories Inc.	UL 1059	E45172
	UR Underwriters Laboratories Inc.	UL 1977	20150318- E45171

### Counterpart



Item no.231-203/026-000

Female plug; 3-pole; 12 AWG max; pin spacing 7.5 mm; 1 conductor per pole; gray

[www.wago.com/231-203/026-000](http://www.wago.com/231-203/026-000)

### Compatible products

#### Coding



Item no.: 231-130

Coding key; snap-on type; light gray

[www.wago.com/231-130](http://www.wago.com/231-130)



Item no.: 231-500

Spacer; for formation of groups; light gray

[www.wago.com/231-500](http://www.wago.com/231-500)

#### Marking accessories



Item no.: 210-833

Marking strips; on reel; 6 mm wide; plain; Self-adhesive; white

[www.wago.com/210-833](http://www.wago.com/210-833)



Item no.: 210-834

Marking strips; on reel; 5 mm wide; plain; Self-adhesive; white

[www.wago.com/210-834](http://www.wago.com/210-834)

### Downloads

#### Documentation

##### Additional Information

Technical explanations

Apr 3, 2019

pdf  
3.6 MB

Download

### CAD files

#### CAD data

2D/3D Models 231-233/001-000/105-604

URL

Download

Subject to changes. Please also observe the further product documentation!

## Installation Notes

### Coding

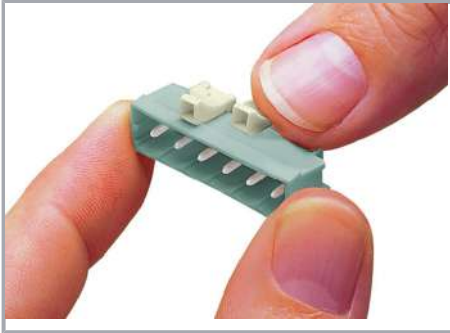

Coding a male header – fitting coding key(s).

### Product family

*MCS* MIDI Classic

[Show all products from the family](#)

Subject to changes. Please also observe the further product documentation!