

Data sheet | Item number: 232-144/031-000

THT female header; 0.6 x 1.0 mm solder pin; straight; clamping collar; Pin spacing 5 mm; 14-pole; gray

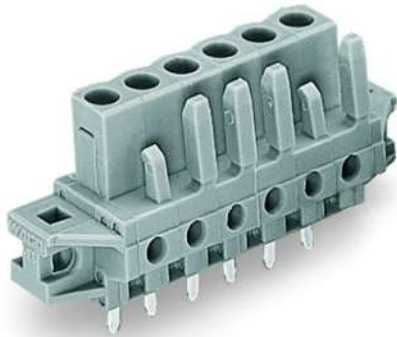

[www.wago.com/232-144\\_031-000](http://www.wago.com/232-144_031-000)



 Picture differs from the item.

RoHS  Compliant



Color: 

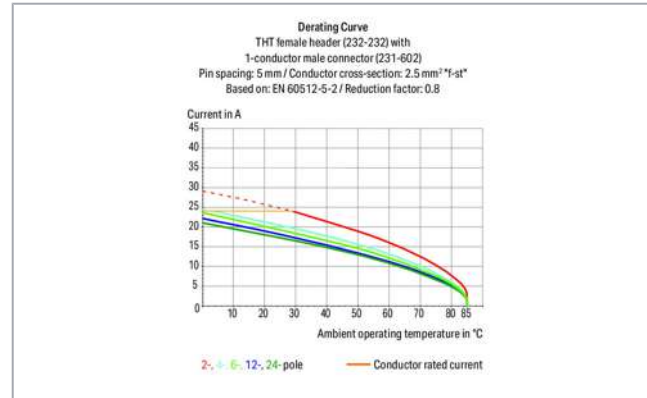

Subject to changes. Please also observe the further product documentation!

WAGO Corporation  
Germantown, WI 53022  
Phone: 1-800-DIN-RAIL (346-7245) | Fax: (262) 255-6222  
Email: [info.us@wago.com](mailto:info.us@wago.com) | Web: [www.wago.us](http://www.wago.us)

Do you have any questions about our products?  
We are always happy to take your call at {0}.

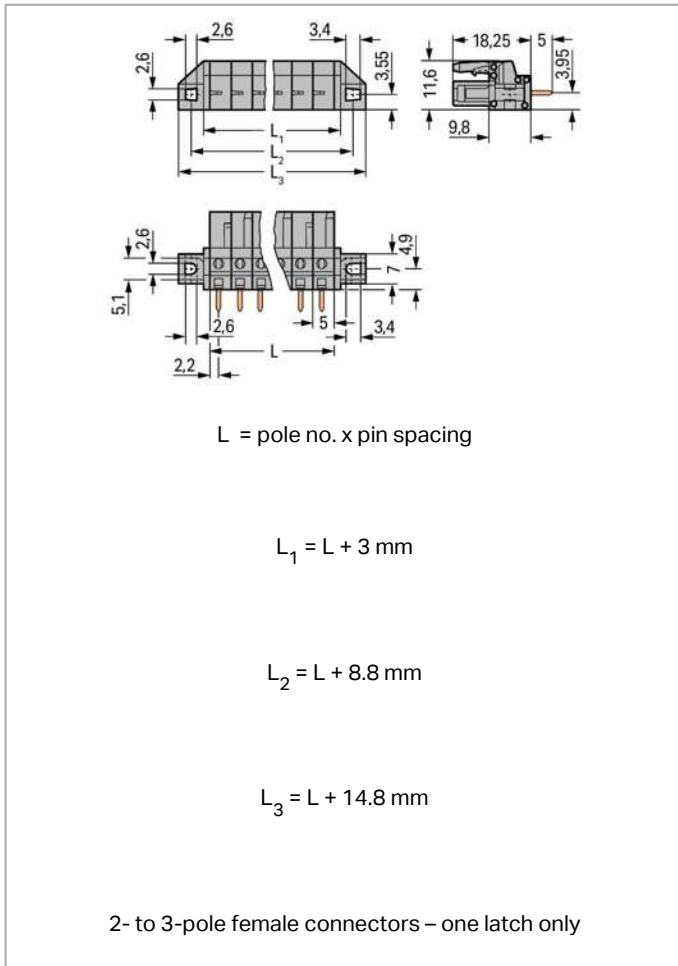

### Item description

- Horizontal or vertical PCB mounting via straight or angled solder pins
- For board-to-board and board-to-wire connections
- Touch-proof PCB outputs
- Easy-to-identify PCB inputs and outputs
- With coding fingers

### Safety information 1:

The MCS – MULTI CONNECTION SYSTEM includes connectors without breaking capacity in accordance with DIN EN 61984. When used as intended, these connectors must not be connected/disconnected when live or under load. The circuit design should ensure header pins, which can be touched, are not live when unmated.

### Data

#### Electrical data

Subject to changes. Please also observe the further product documentation!



### Ratings per IEC/EN 60664-1

Ratings per	IEC/EN 60664-1
Rated voltage (III / 3)	320 V
Rated surge voltage (III/3)	4 kV
Rated voltage (III/2)	320 V
Rated surge voltage (III/2)	4 kV
Nominal voltage (II/2)	630 V
Rated surge voltage (II/2)	4 kV
Rated current	12 A
Legend (ratings)	(III / 2) $\triangleq$ Overvoltage category III / Pollution degree 2

### Ratings per UL 1059

Approvals per	UL 1059
Rated voltage UL (Use Group B)	300 V
Rated current UL (Use Group B)	15 A
Rated voltage UL (Use Group D)	300 V
Rated current UL (Use Group D)	10 A

### Ratings per UL 1977

Rated voltage UL 1977	600 V
Rated current UL 1977	15 A

### Ratings per CSA

Approvals per	CSA
Rated voltage CSA (Use Group B)	300 V
Rated current CSA (Use Group B)	15 A
Rated voltage CSA (Use Group D)	300 V
Rated current CSA (Use Group D)	10 A

### Connection data

Pole No.	14
Total number of potentials	14
Number of connection types	1
Number of levels	1

Subject to changes. Please also observe the further product documentation!

WAGO Corporation  
 Germantown, WI 53022  
 Phone: 1-800-DIN-RAIL (346-7245) | Fax: (262) 255-6222  
 Email: [info.us@wago.com](mailto:info.us@wago.com) | Web: [www.wago.us](http://www.wago.us)

Do you have any questions about our products?  
 We are always happy to take your call at {0}.



## Physical data

Pin spacing	5 mm / 0.197 inch
Width	84.8 mm / 3.339 inch
Height	23.25 mm / 0.915 inch
Height from the surface	18.25 mm / 0.719 inch
Depth	11.6 mm / 0.457 inch
Solder pin length	5 mm
Solder pin dimensions	0.6 x 1 mm
Drilled hole diameter with tolerance	1.3 <sup>(+0.1)</sup> mm

## Mechanical data

Mounting type	Mounting flange
Mounting type	Feed-through mounting Panel mounting

## Plug-in connection

Contact type (pluggable connector)	Female connector/socket
Connector (connection type)	for PCB
Mismating protection	No
Mating direction to the PCB	90°

## PCB contact

PCB contact	THT
Solder pin arrangement	over the entire female connector (in-line)
Number of solder pins per potential	1

## Material Data

Color	gray
Material group	I
Insulation material	Polyamide (PA66)
Flammability class per UL94	V0
Contact material	Copper alloy
Contact plating	tin-plated
Weight	13.5 g

Subject to changes. Please also observe the further product documentation!

WAGO Corporation  
 Germantown, WI 53022  
 Phone: 1-800-DIN-RAIL (346-7245) | Fax: (262) 255-6222  
 Email: [info.us@wago.com](mailto:info.us@wago.com) | Web: [www.wago.us](http://www.wago.us)

Do you have any questions about our products?  
 We are always happy to take your call at {0}.

## Environmental Requirements



Limit temperature range -60 ... +85 °C

## Commercial data

Packaging type	BOX
Country of origin	DE
GTIN	4055143575164
Customs tariff number	85366990990

## Approvals / Certificates

### Ship Approvals

Logo	Approval	Additional Approval Text	Certificate name
	<b>ABS</b> American Bureau of Shipping	-	19- HG15869876- PDA
	<b>BV</b> Bureau Veritas S.A.	IEC 60998	11915/D0 BV
	<b>DNV GL</b> Det Norske Veritas, Germanischer Lloyd	-	TAE 000016Z

### UL-Approvals

Logo	Approval	Additional Approval Text	Certificate name
	<b>UR</b> UL International Germany GmbH	UL 1977	E45171

## Counterpart



Item no.231-614



1-conductor male connector; 2.5 mm<sup>2</sup>; Pin spacing 5 mm; 14-pole; 2,50 mm<sup>2</sup>; gray

[www.wago.com/231-614](http://www.wago.com/231-614)



Subject to changes. Please also observe the further product documentation!

## Compatible products

### check

	<b>Item no.: 210-136</b> Test plug; 2 mm Ø; with 500 mm cable	<a href="http://www.wago.com/210-136">www.wago.com/210-136</a>
	<b>Item no.: 210-137</b> Test plug; 2.3 mm Ø; with 500 mm cable	<a href="http://www.wago.com/210-137">www.wago.com/210-137</a>
	<b>Item no.: 231-661</b> Test plugs for female connectors; for 5 mm and 5.08 mm pin spacing; 2,50 mm <sup>2</sup> ; light gray	<a href="http://www.wago.com/231-661">www.wago.com/231-661</a>

### assembling

	<b>Item no.: 209-147</b> Self-tapping screw	<a href="http://www.wago.com/209-147">www.wago.com/209-147</a>
	<b>Item no.: 231-194</b> Self-tapping screw; B 2.2x13, fixing hole 1.8 mm Ø	<a href="http://www.wago.com/231-194">www.wago.com/231-194</a>
	<b>Item no.: 231-195</b> Screw with nut; M2x12; for fixing element	<a href="http://www.wago.com/231-195">www.wago.com/231-195</a>
	<b>Item no.: 231-295</b> Screw with nut	<a href="http://www.wago.com/231-295">www.wago.com/231-295</a>

## Downloads

### Documentation

#### Additional Information

Technical explanations	Apr 3, 2019	pdf 3.6 MB	Download
------------------------	-------------	---------------	----------

### CAD files

#### CAD data

2D/3D Models 232-144/031-000	URL	Download
------------------------------	-----	----------

#### PCB Design

Symbol and Footprint 232-144/031-000	URL	Download
--------------------------------------	-----	----------

CAX data for your PCB design, consisting of "schematic symbols and PCB footprints", allow easy integration of the WAGO component into your development environment.

#### Supported formats:

—  
Subject to changes. Please also observe the further product documentation!



- Accel EDA 14 & 15
- Altium 6 to current version
- Cadence Allegro
- DesignSpark
- Eagle Libraries
- KiCad
- Mentor Graphics BoardStation
- Mentor Graphics Design Architect
- Mentor Graphics Design Expedition 99 and 2000
- OrCAD 9.X PCB and Capture
- PADS PowerPCB 3, 3.5, 4.X, and 5.X
- PADS PowerPCB and PowerLogic 3.0
- PCAD 2000, 2001, 2002, 2004, and 2006
- Pulsonix 8.5 or newer
- STL
- 3D STEP
- TARGET 3001!
- View Logic ViewDraw
- Quadcept
- Zuken CadStar 3 and 4
- Zuken CR-5000 and CR-8000

PCB Component Libraries (EDA), PCB CAD Library Ultra Librarian

---

#### CAE data

ZUKEN Portal 232-144/031-000

[URL](#)

[Download](#)

---

## Installation Notes

### Application

Subject to changes. Please also observe the further product documentation!

---

WAGO Corporation  
Germantown, WI 53022  
Phone: 1-800-DIN-RAIL (346-7245) | Fax: (262) 255-6222  
Email: [info.us@wago.com](mailto:info.us@wago.com) | Web: [www.wago.us](http://www.wago.us)

Do you have any questions about our products?  
We are always happy to take your call at {0}.

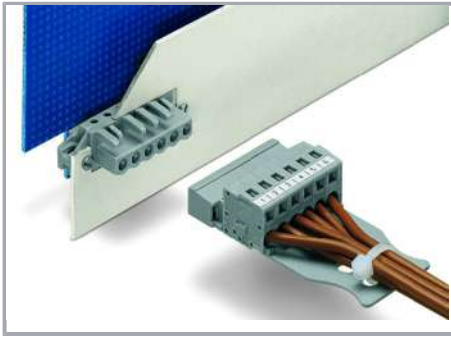

The innovative flange design provides standard panel mounting options or various through-panel mounting configurations. Depending on the type of application and flange, female headers can be used either for through-panel or flush mount applications.

## Product family

[\*MCS\* MIDI Classic](#)

[Show all products from the family](#)

Subject to changes. Please also observe the further product documentation!