

Data sheet | Item number: 232-846/039-000

THT female header; 0.6 x 1.0 mm solder pin; angled; Locking lever; Pin spacing 7.5 mm; 16-pole; gray

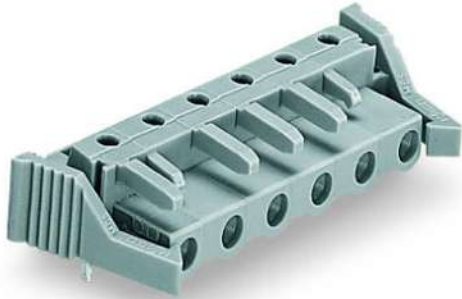

www.wago.com/232-846_039-000



 Picture differs from the item.

RoHS 
Compliant



Color: 

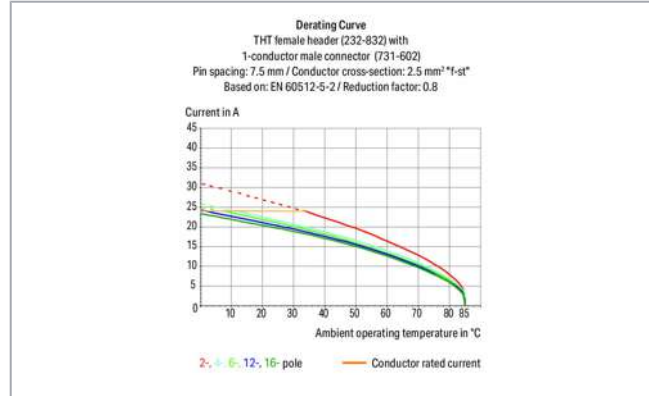

Subject to changes. Please also observe the further product documentation!

WAGO Corporation
Germantown, WI 53022
Phone: 1-800-DIN-RAIL (346-7245) | Fax: (262) 255-6222
Email: info.us@wago.com | Web: www.wago.us

Do you have any questions about our products?
We are always happy to take your call at {0}.

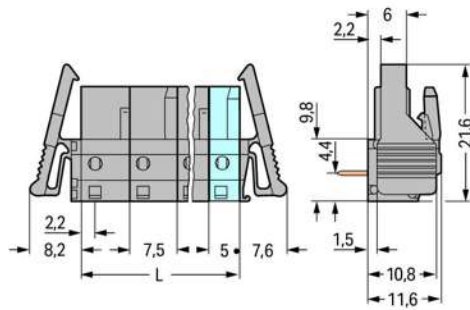

$$L = (\text{pole no.} - 1) \times \text{pin spacing} + 5 \text{ mm}$$

Distance to first solder pin: 2.2 mm

2- to 3-pole female connectors – one latch only

Item description

- Horizontal or vertical PCB mounting via straight or angled solder pins
- For board-to-board and board-to-wire connections
- Touch-proof PCB outputs
- Easy-to-identify PCB inputs and outputs
- With coding fingers

Safety information 1:

The *MCS – MULTI CONNECTION SYSTEM* includes connectors without breaking capacity in accordance with DIN EN 61984. When used as intended, these connectors must not be connected/disconnected when live or under load. The circuit design should ensure header pins, which can be touched, are not live when unmated.

Data

Electrical data

Ratings per IEC/EN 60664-1

Ratings per	IEC/EN 60664-1
Rated voltage (III / 3)	500 V
Rated surge voltage (III/3)	6 kV
Rated voltage (III/2)	630 V

Subject to changes. Please also observe the further product documentation!

WAGO Corporation
 Germantown, WI 53022
 Phone: 1-800-DIN-RAIL (346-7245) | Fax: (262) 255-6222
 Email: info.us@wago.com | Web: www.wago.us

Do you have any questions about our products?
 We are always happy to take your call at {0}.



Rated surge voltage (III/2)	6 kV
Nominal voltage (II/2)	1000 V
Rated surge voltage (II/2)	6 kV
Rated current	12 A
Legend (ratings)	(III / 2) ≙ Overvoltage category III / Pollution degree 2

Ratings per UL 1059

Approvals per	UL 1059
Rated voltage UL (Use Group B)	300 V
Rated current UL (Use Group B)	15 A
Rated voltage UL (Use Group D)	300 V
Rated current UL (Use Group D)	10 A

Ratings per UL 1977

Rated voltage UL 1977	600 V
Rated current UL 1977	15 A

Ratings per CSA

Approvals per	CSA
Rated voltage CSA (Use Group B)	300 V
Rated current CSA (Use Group B)	15 A
Rated voltage CSA (Use Group D)	300 V
Rated current CSA (Use Group D)	10 A

Connection data

Pole No.	16
Total number of potentials	16
Number of connection types	1
Number of levels	1

Physical data

Pin spacing	7.5 mm / 0.295 inch
Width	133.3 mm / 5.248 inch
Height	16.6 mm / 0.654 inch
Height from the surface	11.6 mm / 0.457 inch
Depth	18.25 mm / 0.719 inch

Subject to changes. Please also observe the further product documentation!

WAGO Corporation
 Germantown, WI 53022
 Phone: 1-800-DIN-RAIL (346-7245) | Fax: (262) 255-6222
 Email: info.us@wago.com | Web: www.wago.us

Do you have any questions about our products?
 We are always happy to take your call at {0}.



Solder pin dimensions	0.6 x 1 mm
Drilled hole diameter with tolerance	1.3 ^(+0.1) mm

Plug-in connection

Contact type (pluggable connector)	Female connector/socket
Connector (connection type)	for PCB
Mismating protection	No
Mating direction to the PCB	0°
Locking of plug-in connection	locking lever

PCB contact

PCB contact	THT
Solder pin arrangement	over the entire female connector (in-line)
Number of solder pins per potential	1

Material Data

Color	gray
Material group	I
Insulation material	Polyamide (PA66)
Flammability class per UL94	V0
Contact material	Copper alloy
Contact plating	tin-plated
Weight	18.5 g

Environmental Requirements

Limit temperature range	-60 ... +85 °C
-------------------------	----------------

Commercial data



Packaging type	BOX
Country of origin	DE
GTIN	4055143582209
Customs tariff number	85366990990

Approvals / Certificates



Ship Approvals

Certificate

Subject to changes. Please also observe the further product documentation!

Logo	Approval	Additional Approval Text	name
	ABS American Bureau of Shipping	-	19- HG15869876- PDA
	DNV GL Det Norske Veritas, Germanischer Lloyd	-	TAE000016Z

UL-Approvals

Logo	Approval	Additional Approval Text	Certificate name
	UR Underwriters Laboratories Inc.	UL 1059	E45172
	UR Underwriters Laboratories Inc.	UL 1977	20150318- E45171

Counterpart





Item no.731-616
1-conductor male connector; 2.5 mm²; Pin spacing 7.5 mm; 16-pole; 2,50 mm²; gray

www.wago.com/731-616

Compatible products

check

	Item no.: 210-136 Test plug; 2 mm Ø; with 500 mm cable	www.wago.com/210-136
	Item no.: 210-137 Test plug; 2.3 mm Ø; with 500 mm cable	www.wago.com/210-137
	Item no.: 231-662 Test plugs for female connectors; for 7.5 mm and 7.62 mm pin spacing; 2,50 mm ² ; light gray	www.wago.com/231-662

Marking accessories

	Item no.: 210-833 Marking strips; on reel; 6 mm wide; plain; Self-adhesive; white	www.wago.com/210-833
--	---	--

Subject to changes. Please also observe the further product documentation!

WAGO Corporation
Germantown, WI 53022
Phone: 1-800-DIN-RAIL (346-7245) | Fax: (262) 255-6222
Email: info.us@wago.com | Web: www.wago.us

Do you have any questions about our products?
We are always happy to take your call at {0}.



Item no.: 210-834
Marking strips; on reel; 5 mm wide; plain; Self-adhesive; white

Downloads

Documentation

Additional Information

Technical explanations	Apr 3, 2019	pdf 3.6 MB	Download
------------------------	-------------	---------------	----------

CAD files

PCB Design

Symbol and Footprint 232-846/039-000	URL	Download
--------------------------------------	-----	----------

CAX data for your PCB design, consisting of "schematic symbols and PCB footprints", allow easy integration of the WAGO component into your development environment.

Supported formats:

- Accel EDA 14 & 15
- Altium 6 to current version
- Cadence Allegro
- DesignSpark
- Eagle Libraries
- KiCad
- Mentor Graphics BoardStation
- Mentor Graphics Design Architect
- Mentor Graphics Design Expedition 99 and 2000
- OrCAD 9.X PCB and Capture
- PADS PowerPCB 3, 3.5, 4.X, and 5.X
- PADS PowerPCB and PowerLogic 3.0
- PCAD 2000, 2001, 2002, 2004, and 2006
- Pulsonix 8.5 or newer
- STL
- 3D STEP
- TARGET 3001!
- View Logic ViewDraw
- Quadcept
- Zuken CadStar 3 and 4

—
Subject to changes. Please also observe the further product documentation!

WAGO Corporation
Germantown, WI 53022
Phone: 1-800-DIN-RAIL (346-7245) | Fax: (262) 255-6222
Email: info.us@wago.com | Web: www.wago.us

Do you have any questions about our products?
We are always happy to take your call at {0}.



- Zuken CR-5000 and CR-8000

PCB Component Libraries (EDA), PCB CAD Library Ultra Librarian

Installation Notes

Product family

<i>MCS</i> MIDI Classic

[Show all products from the family](#)

Subject to changes. Please also observe the further product documentation!

WAGO Corporation
Germantown, WI 53022
Phone: 1-800-DIN-RAIL (346-7245) | Fax: (262) 255-6222
Email: info.us@wago.com | Web: www.wago.us

Do you have any questions about our products?
We are always happy to take your call at {0}.