

**Data sheet | Item number: 235-733/331-000**

Stackable 2-conductor PCB terminal block; push-button; 0.75 mm<sup>2</sup>; Pin spacing 10/10.16 mm; 1-pole; PUSH WIRE®; 0,75 mm<sup>2</sup>; light gray

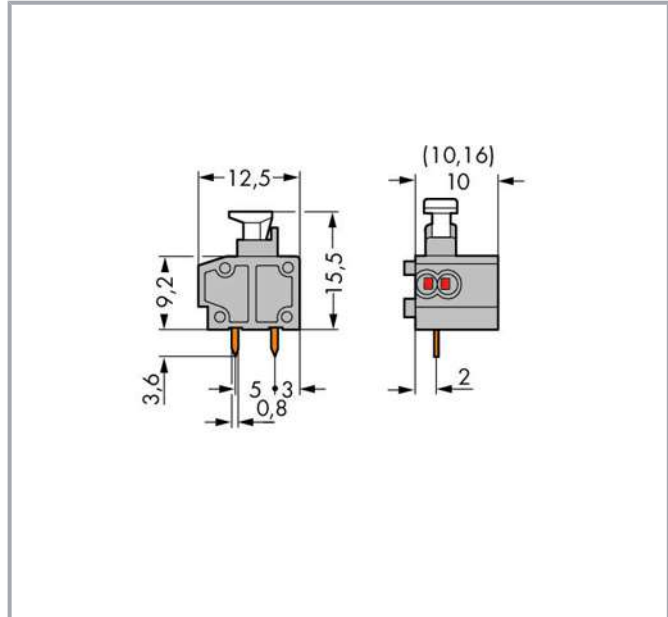

[www.wago.com/235-733\\_331-000](http://www.wago.com/235-733_331-000)



 Picture differs from the item.

Color: 

### Item description

- Modular PCB terminal blocks with push-buttons and PUSH WIRE® connection for custom terminal strip assemblies

Subject to changes. Please also observe the further product documentation!

WAGO Corporation  
Germantown, WI 53022  
Phone: 1-800-DIN-RAIL (346-7245) | Fax: (262) 255-6222  
Email: [info.us@wago.com](mailto:info.us@wago.com) | Web: [www.wago.us](http://www.wago.us)

Do you have any questions about our products?  
We are always happy to take your call at +49 (571) 887-44222.



- Double-wire connection for commoning signals
- Push-in termination of solid conductors
- Easy conductor removal via push-button
- Set to metric or inch pin spacing by compressing PCB terminal strips or pulling them apart
- Also available with a test slot

## Data

### Notes

Variants:

Other colors

Other versions (or variants) can be requested from WAGO Sales or configured at <https://configurator.wago.com/>

## Electrical data

### IEC Approvals

Ratings per	IEC/EN 60664-1
Rated voltage (III / 3)	630 V
Rated surge voltage (III/3)	8 kV
Rated voltage (III/2)	1000 V
Rated surge voltage (III/2)	8 kV
Nominal voltage (II/2)	1000 V
Rated surge voltage (II/2)	8 kV
Rated current	10 A
Legend (ratings)	(III / 2) ≙ Overvoltage category III / Pollution degree 2

### UL Approvals

Approvals per	UL 1059
Rated voltage UL (Use Group B)	300 V
Rated current UL (Use Group B)	10 A
Rated voltage UL (Use Group D)	300 V
Rated current UL (Use Group D)	10 A

### CSA Approvals

Approvals per	CSA
Rated voltage CSA (Use Group B)	300 V
Rated current CSA (Use Group B)	10 A

Subject to changes. Please also observe the further product documentation!

WAGO Corporation  
 Germantown, WI 53022  
 Phone: 1-800-DIN-RAIL (346-7245) | Fax: (262) 255-6222  
 Email: [info.us@wago.com](mailto:info.us@wago.com) | Web: [www.wago.us](http://www.wago.us)

Do you have any questions about our products?  
 We are always happy to take your call at +49 (571) 887-44222.



## Connection data

Total number of connection points	2
Total number of potentials	1
Number of connection types	1
Number of levels	1

## Connection 1

Connection technology	PUSH WIRE®
Actuation type	Push-button
Solid conductor	0.2 ... 0.75 mm <sup>2</sup> / 24 ... 18 AWG
Strip length	9 ... 10 mm / 0.35 ... 0.39 inch
Conductor connection direction to PCB	0°
Number of poles	1

## Physical data

Pin spacing	10/10.16 mm / 0.394/0.4 inch
Width	11.5 mm / 0.453 inch
Height	19.1 mm / 0.752 inch
Height from the surface	15.5 mm / 0.61 inch
Depth	12.5 mm / 0.492 inch
Solder pin length	3.6 mm
Solder pin dimensions	0.8 x 0.4 mm
Drilled hole diameter with tolerance	1 <sup>(+0.1)</sup> mm

## PCB contact

PCB Contact	THT
Solder pin arrangement	within the terminal block (in-line)
Number of solder pins per potential	2

## Material data

Color	light gray
Material group	I
Insulation material	Polyamide (PA66)
Flammability class per UL94	V0
Clamping spring material	Chrome nickel spring steel (CrNi)

Subject to changes. Please also observe the further product documentation!

Contact material	Electrolytic copper (E <sub>Cu</sub> )
Contact plating	tin-plated
Fire load	0.023 MJ
Weight	1.1 g

### Environmental requirements





Limit temperature range	-60 ... +105 °C
-------------------------	-----------------

### Commercial data

Product Group	4 (Printed Circuit)
PU (SPU)	400 (100) Stück
Packaging type	box
Country of origin	CH
GTIN	4044918832229
Customs tariff number	85369010000

### Approvals / Certificates

#### Country specific Approvals

Logo	Approval	Additional Approval Text	Certificate name
	CCA DEKRA Certification B.V.	EN 60947	NTR NL-7144
	CCA DEKRA Certification B.V.	EN 60947	2149549.02
	CCA DEKRA Certification B.V.	EN 60998	NTR NL-6919
	CCA DEKRA Certification B.V.	EN 60947-7-4	NTR NL-7774
	VDE VDE Prüf- und Zertifizierungsinstitut	EN 60947	40029328













Subject to changes. Please also observe the further product documentation!

## Ship Approvals

Logo	Approval	Additional Approval Text	Certificate name
	<b>ABS</b> American Bureau of Shipping	-	19- HG1869876- PDA
	<b>DNV GL</b> Det Norske Veritas, Germanischer Lloyd	-	TAE000016Z

## Optional accessories

## Ferrules

















Ferrule		
	<b>Item no.: 216-101</b> Ferrule; Sleeve for 0.5 mm <sup>2</sup> / AWG 22; uninsulated; electro-tin plated; silver-colored	<a href="http://www.wago.com/216-101">www.wago.com/216-101</a>
	<b>Item no.: 216-104</b> Ferrule; Sleeve for 1.5 mm <sup>2</sup> / AWG 16; uninsulated; electro-tin plated; silver-colored	<a href="http://www.wago.com/216-104">www.wago.com/216-104</a>
	<b>Item no.: 216-106</b> Ferrule; Sleeve for 2.5 mm <sup>2</sup> / AWG 14; uninsulated; electro-tin plated; silver-colored	<a href="http://www.wago.com/216-106">www.wago.com/216-106</a>
	<b>Item no.: 216-107</b> Ferrule; Sleeve for 4 mm <sup>2</sup> / AWG 12; uninsulated; electro-tin plated	<a href="http://www.wago.com/216-107">www.wago.com/216-107</a>
	<b>Item no.: 216-108</b> Ferrule; Sleeve for 6 mm <sup>2</sup> / AWG 10; uninsulated; electro-tin plated; silver-colored	<a href="http://www.wago.com/216-108">www.wago.com/216-108</a>
	<b>Item no.: 216-109</b> Ferrule; Sleeve for 10 mm <sup>2</sup> / AWG 8; uninsulated; electro-tin plated	<a href="http://www.wago.com/216-109">www.wago.com/216-109</a>
	<b>Item no.: 216-102</b> Ferrule; Sleeve for 0.75 mm <sup>2</sup> / AWG 20; uninsulated; electro-tin plated; silver-colored	<a href="http://www.wago.com/216-102">www.wago.com/216-102</a>
	<b>Item no.: 216-103</b> Ferrule; Sleeve for 1 mm <sup>2</sup> / AWG 18; uninsulated; electro-tin plated	<a href="http://www.wago.com/216-103">www.wago.com/216-103</a>
	<b>Item no.: 216-110</b> Ferrule; Sleeve for 16 mm <sup>2</sup> / AWG 6; uninsulated; electro-tin plated; metallic brown	<a href="http://www.wago.com/216-110">www.wago.com/216-110</a>
	<b>Item no.: 216-123</b> Ferrule; Sleeve for 1 mm <sup>2</sup> / AWG 18; uninsulated; electro-tin plated; silver-colored	<a href="http://www.wago.com/216-123">www.wago.com/216-123</a>
	<b>Item no.: 216-122</b> Ferrule; Sleeve for 0.75 mm <sup>2</sup> / AWG 20; uninsulated; electro-tin plated; silver-colored	<a href="http://www.wago.com/216-122">www.wago.com/216-122</a>
	<b>Item no.: 216-124</b> Ferrule; Sleeve for 1.5 mm <sup>2</sup> / AWG 16; uninsulated; electro-tin plated	<a href="http://www.wago.com/216-124">www.wago.com/216-124</a>

Subject to changes. Please also observe the further product documentation!

	<b>Item no.: 216-142</b> Ferrule; Sleeve for 0.75 mm <sup>2</sup> / 18 AWG; uninsulated; electro-tin plated; electrolytic copper; gastight crimped; acc. to DIN 46228, Part 1/08.92	<a href="http://www.wago.com/216-142">www.wago.com/216-142</a>
	<b>Item no.: 216-132</b> Ferrule; Sleeve for 0.34 mm <sup>2</sup> / AWG 24; uninsulated; electro-tin plated	<a href="http://www.wago.com/216-132">www.wago.com/216-132</a>
	<b>Item no.: 216-121</b> Ferrule; Sleeve for 0.5 mm <sup>2</sup> / AWG 22; uninsulated; electro-tin plated; silver-colored	<a href="http://www.wago.com/216-121">www.wago.com/216-121</a>
	<b>Item no.: 216-143</b> Ferrule; Sleeve for 1 mm <sup>2</sup> / AWG 18; uninsulated; electro-tin plated; electrolytic copper; gastight crimped; acc. to DIN 46228, Part 1/08.92	<a href="http://www.wago.com/216-143">www.wago.com/216-143</a>
	<b>Item no.: 216-131</b> Ferrule; Sleeve for 0.25 mm <sup>2</sup> / AWG 24; uninsulated; electro-tin plated; silver-colored	<a href="http://www.wago.com/216-131">www.wago.com/216-131</a>
	<b>Item no.: 216-141</b> Ferrule; Sleeve for 0.5 mm <sup>2</sup> / 20 AWG; uninsulated; electro-tin plated; electrolytic copper; gastight crimped; acc. to DIN 46228, Part 1/08.92	<a href="http://www.wago.com/216-141">www.wago.com/216-141</a>
	<b>Item no.: 216-152</b> Ferrule; Sleeve for 0.34 mm <sup>2</sup> / AWG 24; uninsulated; electro-tin plated	<a href="http://www.wago.com/216-152">www.wago.com/216-152</a>
	<b>Item no.: 216-203</b> Ferrule; Sleeve for 1 mm <sup>2</sup> / AWG 18; insulated; electro-tin plated; red	<a href="http://www.wago.com/216-203">www.wago.com/216-203</a>
	<b>Item no.: 216-206</b> Ferrule; Sleeve for 2.5 mm <sup>2</sup> / AWG 14; insulated; electro-tin plated; blue	<a href="http://www.wago.com/216-206">www.wago.com/216-206</a>
	<b>Item no.: 216-207</b> Ferrule; Sleeve for 4 mm <sup>2</sup> / AWG 12; insulated; electro-tin plated; gray	<a href="http://www.wago.com/216-207">www.wago.com/216-207</a>
	<b>Item no.: 216-202</b> Ferrule; Sleeve for 0.75 mm <sup>2</sup> / 18 AWG; insulated; electro-tin plated; gray	<a href="http://www.wago.com/216-202">www.wago.com/216-202</a>
	<b>Item no.: 216-151</b> Ferrule; Sleeve for 0.25 mm <sup>2</sup> / AWG 24; uninsulated; electro-tin plated	<a href="http://www.wago.com/216-151">www.wago.com/216-151</a>
	<b>Item no.: 216-204</b> Ferrule; Sleeve for 1.5 mm <sup>2</sup> / AWG 16; insulated; electro-tin plated; black	<a href="http://www.wago.com/216-204">www.wago.com/216-204</a>
	<b>Item no.: 216-209</b> Ferrule; Sleeve for 10 mm <sup>2</sup> / AWG 8; insulated; electro-tin plated; red	<a href="http://www.wago.com/216-209">www.wago.com/216-209</a>
	<b>Item no.: 216-205</b> Ferrule; Sleeve for 2.08 mm <sup>2</sup> / AWG 14; insulated; electro-tin plated; yellow	<a href="http://www.wago.com/216-205">www.wago.com/216-205</a>
	<b>Item no.: 216-144</b> Ferrule; Sleeve for 1.5 mm <sup>2</sup> / AWG 16; uninsulated; electro-tin plated; electrolytic copper; gastight crimped; acc. to DIN 46228, Part 1/08.92; silver-colored	<a href="http://www.wago.com/216-144">www.wago.com/216-144</a>
	<b>Item no.: 216-208</b> Ferrule; Sleeve for 6 mm <sup>2</sup> / AWG 10; insulated; electro-tin plated; electrolytic copper; gastight crimped; acc. to DIN 46228, Part 4/09.90; yellow	<a href="http://www.wago.com/216-208">www.wago.com/216-208</a>

Subject to changes. Please also observe the further product documentation!











	<b>Item no.: 216-201</b> Ferrule; Sleeve for 0.5 mm <sup>2</sup> / 20 AWG; insulated; electro-tin plated; white	<a href="http://www.wago.com/216-201">www.wago.com/216-201</a>
	<b>Item no.: 216-223</b> Ferrule; Sleeve for 1 mm <sup>2</sup> / AWG 18; insulated; electro-tin plated; red	<a href="http://www.wago.com/216-223">www.wago.com/216-223</a>
	<b>Item no.: 216-210</b> Ferrule; Sleeve for 16 mm <sup>2</sup> / AWG 6; insulated; electro-tin plated; electrolytic copper; gastight crimped; acc. to DIN 46228, Part 4/09.90; blue	<a href="http://www.wago.com/216-210">www.wago.com/216-210</a>
	<b>Item no.: 216-241</b> Ferrule; Sleeve for 0.5 mm <sup>2</sup> / 20 AWG; insulated; electro-tin plated; electrolytic copper; gastight crimped; acc. to DIN 46228, Part 4/09.90; white	<a href="http://www.wago.com/216-241">www.wago.com/216-241</a>
	<b>Item no.: 216-242</b> Ferrule; Sleeve for 0.75 mm <sup>2</sup> / 18 AWG; insulated; electro-tin plated; electrolytic copper; gastight crimped; acc. to DIN 46228, Part 4/09.90; gray	<a href="http://www.wago.com/216-242">www.wago.com/216-242</a>
	<b>Item no.: 216-222</b> Ferrule; Sleeve for 0.75 mm <sup>2</sup> / 18 AWG; insulated; electro-tin plated; gray	<a href="http://www.wago.com/216-222">www.wago.com/216-222</a>
	<b>Item no.: 216-221</b> Ferrule; Sleeve for 0.5 mm <sup>2</sup> / 20 AWG; insulated; electro-tin plated; white	<a href="http://www.wago.com/216-221">www.wago.com/216-221</a>
	<b>Item no.: 216-224</b> Ferrule; Sleeve for 1.5 mm <sup>2</sup> / AWG 16; insulated; electro-tin plated; black	<a href="http://www.wago.com/216-224">www.wago.com/216-224</a>
	<b>Item no.: 216-243</b> Ferrule; Sleeve for 1 mm <sup>2</sup> / AWG 18; insulated; electro-tin plated; electrolytic copper; gastight crimped; acc. to DIN 46228, Part 4/09.90; red	<a href="http://www.wago.com/216-243">www.wago.com/216-243</a>
	<b>Item no.: 216-244</b> Ferrule; Sleeve for 1.5 mm <sup>2</sup> / AWG 16; insulated; electro-tin plated; electrolytic copper; gastight crimped; acc. to DIN 46228, Part 4/09.90; black	<a href="http://www.wago.com/216-244">www.wago.com/216-244</a>
	<b>Item no.: 216-263</b> Ferrule; Sleeve for 1 mm <sup>2</sup> / AWG 18; insulated; electro-tin plated; electrolytic copper; gastight crimped; acc. to DIN 46228, Part 4/09.90; red	<a href="http://www.wago.com/216-263">www.wago.com/216-263</a>
	<b>Item no.: 216-246</b> Ferrule; Sleeve for 2.5 mm <sup>2</sup> / AWG 14; insulated; electro-tin plated; electrolytic copper; gastight crimped; acc. to DIN 46228, Part 4/09.90; blue	<a href="http://www.wago.com/216-246">www.wago.com/216-246</a>
	<b>Item no.: 216-266</b> Ferrule; Sleeve for 2.5 mm <sup>2</sup> / AWG 14; insulated; electro-tin plated; electrolytic copper; gastight crimped; acc. to DIN 46228, Part 4/09.90; blue	<a href="http://www.wago.com/216-266">www.wago.com/216-266</a>
	<b>Item no.: 216-264</b> Ferrule; Sleeve for 1.5 mm <sup>2</sup> / AWG 16; insulated; electro-tin plated; electrolytic copper; gastight crimped; acc. to DIN 46228, Part 4/09.90; black	<a href="http://www.wago.com/216-264">www.wago.com/216-264</a>
	<b>Item no.: 216-284</b> Ferrule; Sleeve for 1.5 mm <sup>2</sup> / AWG 16; insulated; electro-tin plated; electrolytic copper; gastight crimped; acc. to DIN 46228, Part 4/09.90; black	<a href="http://www.wago.com/216-284">www.wago.com/216-284</a>
	<b>Item no.: 216-286</b> Ferrule; Sleeve for 2.5 mm <sup>2</sup> / AWG 14; insulated; electro-tin plated; electrolytic copper; gastight crimped; acc. to DIN 46228, Part 4/09.90; blue	<a href="http://www.wago.com/216-286">www.wago.com/216-286</a>
	<b>Item no.: 216-287</b> Ferrule; Sleeve for 4 mm <sup>2</sup> / AWG 12; insulated; electro-tin plated; electrolytic copper; gastight crimped;	<a href="http://www.wago.com/216-287">www.wago.com/216-287</a>

Subject to changes. Please also observe the further product documentation!



acc. to DIN 46228, Part 4/09.90; gray

	<b>Item no.: 216-262</b> Ferrule; Sleeve for 0.75 mm <sup>2</sup> / 18 AWG; insulated; electro-tin plated; electrolytic copper; gastight crimped; acc. to DIN 46228, Part 4/09.90; gray	<a href="http://www.wago.com/216-262">www.wago.com/216-262</a>
	<b>Item no.: 216-288</b> Ferrule; Sleeve for 6 mm <sup>2</sup> / AWG 10; insulated; electro-tin plated; electrolytic copper; gastight crimped; acc. to DIN 46228, Part 4/09.90; yellow	<a href="http://www.wago.com/216-288">www.wago.com/216-288</a>
	<b>Item no.: 216-289</b> Ferrule; Sleeve for 10 mm <sup>2</sup> / AWG 8; insulated; electro-tin plated; electrolytic copper; gastight crimped; acc. to DIN 46228, Part 4/09.90; red	<a href="http://www.wago.com/216-289">www.wago.com/216-289</a>
	<b>Item no.: 216-301</b> Ferrule; Sleeve for 0.25 mm <sup>2</sup> / AWG 24; insulated; electro-tin plated; yellow	<a href="http://www.wago.com/216-301">www.wago.com/216-301</a>
	<b>Item no.: 216-321</b> Ferrule; Sleeve for 0.25 mm <sup>2</sup> / AWG 24; insulated; electro-tin plated; yellow	<a href="http://www.wago.com/216-321">www.wago.com/216-321</a>
	<b>Item no.: 216-322</b> Ferrule; Sleeve for 0.34 mm <sup>2</sup> / 22 AWG; insulated; electro-tin plated; green	<a href="http://www.wago.com/216-322">www.wago.com/216-322</a>
	<b>Item no.: 216-267</b> Ferrule; Sleeve for 4 mm <sup>2</sup> / AWG 12; insulated; electro-tin plated; electrolytic copper; gastight crimped; acc. to DIN 46228, Part 4/09.90; gray	<a href="http://www.wago.com/216-267">www.wago.com/216-267</a>
	<b>Item no.: 216-302</b> Ferrule; Sleeve for 0.34 mm <sup>2</sup> / 22 AWG; insulated; electro-tin plated; light turquoise	<a href="http://www.wago.com/216-302">www.wago.com/216-302</a>

**End plates**

End plate		
	<b>Item no.: 235-300</b> End plate; snap-fit type; 1 mm thick; light gray	<a href="http://www.wago.com/235-300">www.wago.com/235-300</a>

**Downloads**

**Documentation**

**Additional Information**

Technical explanations	2019 Apr 3	pdf 2.0 MB	Download
------------------------	------------	---------------	----------

**Installation Notes**

**Installation**

Subject to changes. Please also observe the further product documentation!

WAGO Corporation  
 Germantown, WI 53022  
 Phone: 1-800-DIN-RAIL (346-7245) | Fax: (262) 255-6222  
 Email: [info.us@wago.com](mailto:info.us@wago.com) | Web: [www.wago.us](http://www.wago.us)

Do you have any questions about our products?  
 We are always happy to take your call at +49 (571) 887-44222.





Combining 1- and 2-conductor terminal blocks with different pin spacing.

Subject to changes. Please also observe the further product documentation!

---

WAGO Corporation  
Germantown, WI 53022  
Phone: 1-800-DIN-RAIL (346-7245) | Fax: (262) 255-6222  
Email: [info.us@wago.com](mailto:info.us@wago.com) | Web: [www.wago.us](http://www.wago.us)

Do you have any questions about our products?  
We are always happy to take your call at +49 (571) 887-44222.