

Data sheet | Item number: 253-104/000-006

2-conductor PCB terminal block; 1.5 mm²; Pin spacing 5 mm; 4-pole; PUSH WIRE®; 1,50 mm²; blue

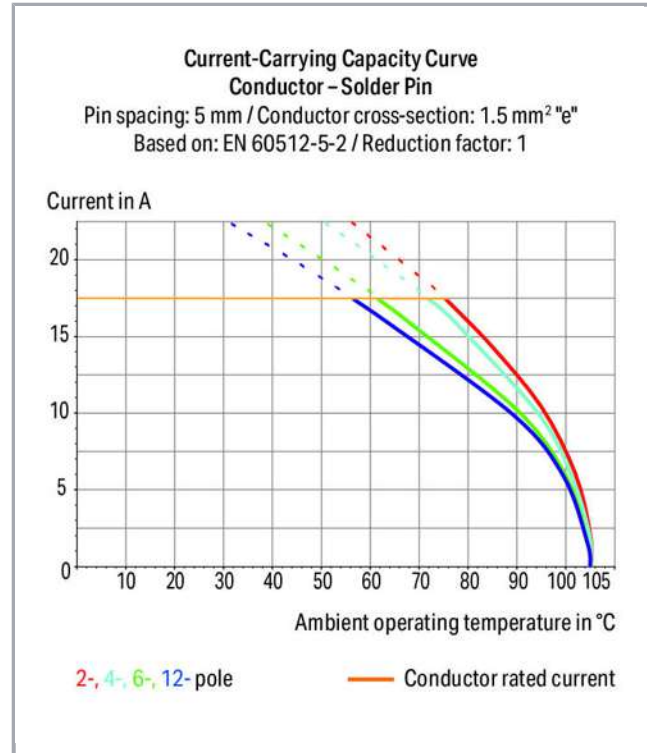

www.wago.com/253-104_000-006



Subject to changes. Please also observe the further product documentation!

WAGO Kontakttechnik GmbH & Co. KG
Hansastr. 27
32423 Minden
Phone: +49571 887-0 | Fax: +49571 887-169
Email: info.de@wago.com | Web: www.wago.com

Do you have any questions about our products?
We are always happy to take your call at +49 (571) 887-44222.

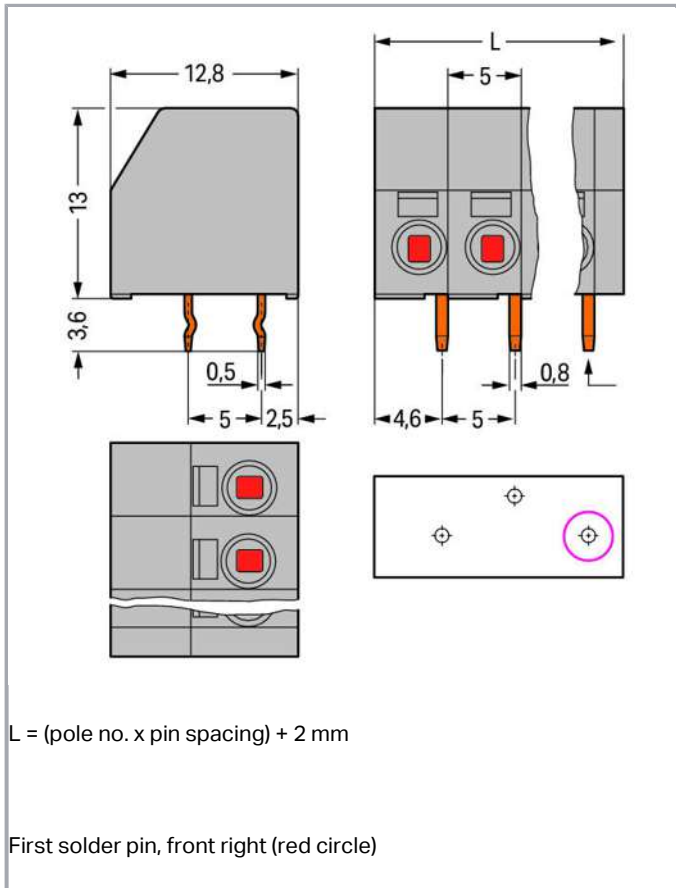

Item description

- PCB terminal strips with screwdriver-actuated PUSH WIRE® termination
- Double-conductor connection provides top-entry (vertical) and/or side-entry (horizontal) wiring
- Push-in termination of solid conductors
- Double entries for power supply and potential distribution

Data

Electrical data

Ratings per IEC/EN 60664-1

Ratings per	IEC/EN 60664-1
Rated voltage (III / 3)	320 V
Rated impulse voltage (III / 3)	4 kV
Rated voltage (III / 2)	320 V

Subject to changes. Please also observe the further product documentation!

WAGO Kontakttechnik GmbH & Co. KG
 Hansastr. 27
 32423 Minden
 Phone: +49571 887-0 | Fax: +49571 887-169
 Email: info.de@wago.com | Web: www.wago.com

Do you have any questions about our products?
 We are always happy to take your call at +49 (571) 887-44222.



Rated impulse voltage (III / 2)	4 kV
Rated voltage (II / 2)	630 V
Rated impulse voltage (II / 2)	4 kV
Rated current	17.5 A
Legend (ratings)	(III / 2) $\hat{=}$ Overvoltage category III / Pollution degree 2

Approvals per UL 1059

Rated voltage UL (Use Group B)	300 V
Rated current UL (Use Group B)	8 A
Rated voltage UL (Use Group D)	300 V
Rated current UL (Use Group D)	8 A
Approvals per	UL 1059

Approvals per CSA

Rated voltage CSA (Use Group B)	300 V
Rated current CSA (Use Group B)	8 A
Rated voltage CSA (Use Group D)	300 V
Rated current CSA (Use Group D)	8 A

Connection data

Connection type (1)	PUSH WIRE® connection
Connection technology	PUSH WIRE®
Number of connection points (connection type)	1
Actuation type	Operating tool
Solid conductor	0,5 ... 1,5 mm ² / 20 ... 16 AWG
Strip length	8,5 ... 9,5 mm / 0.33 ... 0.37 inch
Note (strip length)	7 ... 8 mm / 0.28 ... 0.31 inch (for wiring on both sides)
Conductor entry angle to the PCB	0°
No. of poles	4
Connection type (2)	PUSH WIRE® connection
Connection technology 2	PUSH WIRE®
Number of connection points	1
Solid conductor (2)	0,5 ... 1,5 mm ² / 20 ... 16 AWG
Strip length (2)	8,5 ... 9,5 mm / 0.33 ... 0.37 inch
Note (strip length) 2	7 ... 8 mm / 0.28 ... 0.31 inch (for wiring on both sides)
Conductor entry angle to the PCB 2	90°

Subject to changes. Please also observe the further product documentation!



Total number of connection points	8
Total number of potentials	4
Number of connection types	2
Number of levels	2

Geometrical Data

Pin spacing	5 mm / 0.197 inch
Width	22 mm / 0.866 inch
Height	16,6 mm / 0.654 inch
Height from the surface	13 mm / 0.512 inch
Depth	12,8 mm / 0.504 inch
Solder pin length	3.6 mm
Solder pin dimensions	0,5 x 0,8 mm
Drilled hole diameter (tolerance)	1,1 (+0,1) mm

PCB contact

PCB contact	THT
Solder pin arrangement	over the entire terminal strip (staggered)
Number of solder pins per potential	1

Material Data

Color	blue
Material group	I
Insulating material	Polyamide 66 (PA 66)
Flammability class per UL94	V0
Clamping spring material	Chrome nickel spring steel (CrNi)
Contact material	Electrolytic copper (E_{Cu})
Contact plating	tin-plated
Weight	3.7 g

Environmental Requirements

Limit temperature range	-60 ... +105 °C
-------------------------	-----------------

Commercial data



Packaging type	BOX
----------------	-----

Subject to changes. Please also observe the further product documentation!

Country of origin	CN
GTIN	4045454147099

Approvals / Certificates

UL-Approvals

Logo	Approval	Additional Approval Text	Certificate name
	cURus Underwriters Laboratories Inc.	UL 1059	E45172 sec. 6
	UL UL International Germany GmbH	UL 1977	E45171

Counterpart

Compatible products

Marking accessories

	Item no.: 210-332/500-202 Marking strips; as a DIN A4 sheet; MARKED; 1-16 (160x); Height of marker strip: 3 mm; Strip length 182 mm; Horizontal marking; Self-adhesive; white	www.wago.com/210-332/500-202
	Item no.: 210-332/500-204 Marking strips; as a DIN A4 sheet; MARKED; 17-32 (160x); Height of marker strip: 3 mm; Strip length 182 mm; Horizontal marking; Self-adhesive; white	www.wago.com/210-332/500-204
	Item no.: 210-332/500-205 Marking strips; as a DIN A4 sheet; MARKED; 1-32 (80x); Height of marker strip: 3 mm; Strip length 182 mm; Horizontal marking; Self-adhesive; white	www.wago.com/210-332/500-205
	Item no.: 210-332/500-206 Marking strips; as a DIN A4 sheet; MARKED; 33-48 (160x); Height of marker strip: 3 mm; Strip length 182 mm; Horizontal marking; Self-adhesive; white	www.wago.com/210-332/500-206
	Item no.: 210-833 Marking strips; on reel; 6 mm wide; plain; Self-adhesive; white	www.wago.com/210-833

tools

	Item no.: 210-647 Operating tool; Blade: 2.5 x 0.4 mm; with a partially insulated shaft	www.wago.com/210-647
--	---	--

Subject to changes. Please also observe the further product documentation!



Item no.: 210-648

Operating tool; Blade: 2.5 x 0.4 mm; with a partially insulated shaft; angled; short

www.wago.com/210-648



Item no.: 210-719

Operating tool; Blade: 2.5 x 0.4 mm; with a partially insulated shaft

www.wago.com/210-719

Downloads

Documentation

Additional Information

Technical explanations	Apr 3, 2019	pdf 3.6 MB	Download
------------------------	-------------	---------------	----------

CAD/CAE-Data

CAD data

2D/3D Models 253-104/000-006	URL	Download
------------------------------	-----	----------

CAE data

EPLAN Data Portal 253-104/000-006	URL	Download
-----------------------------------	-----	----------

PCB Design

Symbol and Footprint 253-104/000-006	URL	Download
--------------------------------------	-----	----------

CAX data for your PCB design, consisting of "schematic symbols and PCB footprints", allow easy integration of the WAGO component into your development environment.

Supported formats:

- Accel EDA 14 & 15
- Altium 6 to current version
- Cadence Allegro
- DesignSpark
- Eagle Libraries
- KiCad
- Mentor Graphics BoardStation
- Mentor Graphics Design Architect
- Mentor Graphics Design Expedition 99 and 2000
- OrCAD 9.X PCB and Capture
- PADS PowerPCB 3, 3.5, 4.X, and 5.X
- PADS PowerPCB and PowerLogic 3.0

Subject to changes. Please also observe the further product documentation!

- PCAD 2000, 2001, 2002, 2004, and 2006
- Pulsonix 8.5 or newer
- STL
- 3D STEP
- TARGET 3001!
- View Logic ViewDraw
- Quadcept
- Zuken CadStar 3 and 4
- Zuken CR-5000 and CR-8000

PCB Component Libraries (EDA), PCB CAD Library Ultra Librarian

Installation Notes

Conductor termination

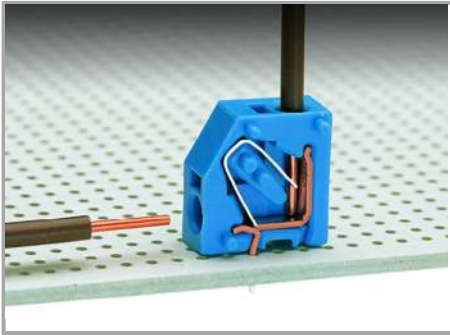

Inserting a conductor via push-in termination.

Conductor removal

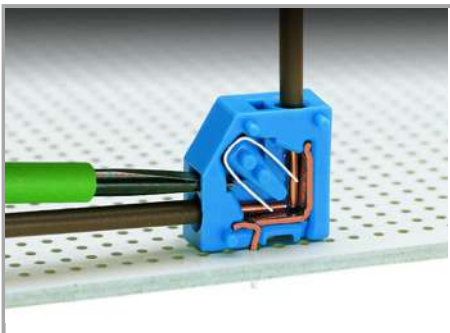

Removing a conductor via 2.5 mm screwdriver.

Subject to changes. Please also observe the further product documentation!

Installation

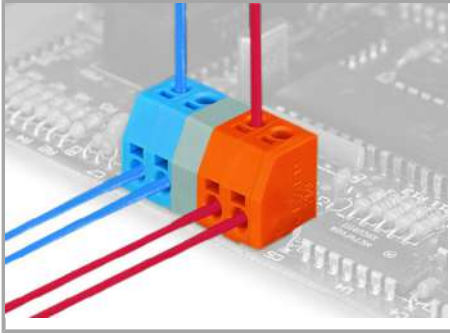

Mixed-color terminal strips (with or without spacer) are available upon request.

Subject to changes. Please also observe the further product documentation!

WAGO Kontakttechnik GmbH & Co. KG
Hansastr. 27
32423 Minden
Phone: +49571 887-0 | Fax: +49571 887-169
Email: info.de@wago.com | Web: www.wago.com

Do you have any questions about our products?
We are always happy to take your call at +49 (571) 887-44222.