

Data sheet | Item number: 285-1163

POWER CAGE CLAMP feedthrough terminal block; suitable for Ex e II applications; with fixing flanges; 2-conductor; 350 kcmil; 32 mm wide; light gray

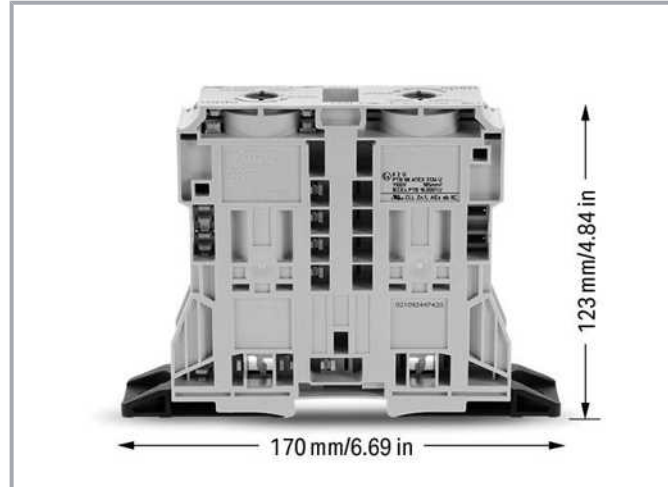

www.wago.com/285-1163



Color:

Data

Electrical data

IEC Approvals

Ratings per

IEC/EN 60947-7-1

UL Approvals

Approvals per

UL 1059

Rated voltage UL (Use Group B)

600 V

Rated current UL (Use Group B)

310 A

Rated voltage UL (Use Group C)

600 V

Rated current UL (Use Group C)

310 A

CSA Approvals

Approvals per

C22.2 No 158

Subject to changes. Please also observe the further product documentation!

WAGO Corporation
Germantown, WI 53022
Phone: 1-800-DIN-RAIL (346-7245) | Fax: (262) 255-6222
Email: info.us@wago.com | Web: www.wago.us

Do you have any questions about our products?
We are always happy to take your call at +49 (571) 887-44222.



Rated voltage CSA (Use Group B)	1000 V
Rated current CSA (Use Group B)	310 A
Rated voltage CSA (Use Group D)	1000 V
Rated current CSA (Use Group D)	310 A

Ex information

Ratings per	ATEX: PTB 98 ATEX 3134 U (Ex eb IIC Gb)
Rated voltage EN (Ex e II)	1,000 V
Rated current (Ex e II)	250 A
Rated current (Ex e II) with jumper	236 A

Connection data

Total number of connection points	2
Total number of potentials	1
Number of levels	1

Connection 1

Connection technology	POWER CAGE CLAMP
Actuation type	Operating tool
Connectable conductor materials	Copper
Nominal cross-section	185 mm ²
Solid conductor	50 ... 185 mm ² / 1/0 AWG ... 350 kcmil
Stranded conductor	50 ... 185 mm ² / 1/0 AWG ... 350 kcmil
Fine-stranded conductor	50 ... 185 mm ² / 1/0 AWG ... 350 kcmil
Fine-stranded conductor; with insulated ferrule	50 ... 150 mm ² / 1/0 AWG ... 300 kcmil
Fine-stranded conductor; with uninsulated ferrule	50 ... 185 mm ² / 1/0 AWG ... 350 kcmil
Strip length	45 ... 47 mm / 1.77 ... 1.85 inch
Wiring direction	Side-entry wiring

Physical data

Width	32 mm / 1.26 inch
Height from the surface	123 mm / 4.843 inch
Depth	170 mm / 6.693 inch

Mechanical data

Design	horizontal type
--------	-----------------

Subject to changes. Please also observe the further product documentation!

WAGO Corporation
 Germantown, WI 53022
 Phone: 1-800-DIN-RAIL (346-7245) | Fax: (262) 255-6222
 Email: info.us@wago.com | Web: www.wago.us

Do you have any questions about our products?
 We are always happy to take your call at +49 (571) 887-44222.

Mounting type	Mounting flange
Marking level	Side marking

Material data





Color	light gray
Insulation material	Polyamide (PA66)
Flammability class per UL94	V0
Fire load	0.576 MJ
Weight	546.2 g

Commercial data

PU (SPU)	4 Stück
Packaging type	box
Country of origin	DE
GTIN	4055143753586
Customs tariff number	85369010000



Approvals / Certificates

Ex-Approvals

Logo	Approval	Additional Approval Text	Certificate name
	AEx Underwriters Laboratories Inc.	-	E185892 sec. 4
	ATEX Physikalisch Technische Bundesanstalt	EN 60079-0	PTB 98 ATEX 3134 U (II 2 G Ex eb IIC Gb or I M 2 Ex eb I Mb)
	CCCEX CQST/CNEX	CNCA-C23-01	2020312313000177
	EAC Brjansker Zertifizierungsstelle	TP TC 012/2011	RU C-DE.AM02.B. 00127/19
	IECEX Physikalisch Technische Bundesanstalt	IEC 60079-0	IECEX PTB 16.0001 U (Ex eb IIC Gb or Ex eb I Mb)

Subject to changes. Please also observe the further product documentation!

Country specific Approvals

Logo	Approval	Additional Approval Text	Certificate name
	CCA DEKRA Certification B.V.	EN 60947	NTR NL 7648
	CCA DEKRA Certification B.V.	EN 60947	2194773.01
	CSA DEKRA Certification B.V.	C22.2	1151144

Ship Approvals

Logo	Approval	Additional Approval Text	Certificate name
	ABS American Bureau of Shipping	EN 60947	20- HG1941090- PDA

UL-Approvals

Logo	Approval	Additional Approval Text	Certificate name
	UL Underwriters Laboratories Inc.	UL 1059	E45172

Optional accessories

Mounting





	Item no.: 285-1179 Fixing element; for 185 mm ² high-current terminal blocks; orange	www.wago.com/285-1179
--	--	--

Marking accessories

•	Item no.: 2009-110 Marking strips; for Smart Printer; on reel; not stretchable; plain; snap-on type; white	www.wago.com/2009-110
•	Item no.: 2009-115 WMB-Inline; for Smart Printer; 1500 pieces on roll; stretchable 5 - 5.2 mm; plain; snap-on type; white	www.wago.com/2009-115













Subject to changes. Please also observe the further product documentation!



•	Item no.: 2009-115/000-002 WMB-Inline; for Smart Printer; 1500 pieces on roll; stretchable 5 - 5.2 mm; plain; snap-on type; yellow	www.wago.com/2009-115/000-002
•	Item no.: 2009-115/000-005 WMB-Inline; for Smart Printer; 1500 pieces on roll; stretchable 5 - 5.2 mm; plain; snap-on type; red	www.wago.com/2009-115/000-005
•	Item no.: 2009-115/000-006 WMB-Inline; for Smart Printer; 1500 pieces on roll; stretchable 5 - 5.2 mm; plain; snap-on type; blue	www.wago.com/2009-115/000-006
•	Item no.: 2009-115/000-007 WMB-Inline; for Smart Printer; 1500 pieces on roll; stretchable 5 - 5.2 mm; plain; snap-on type; gray	www.wago.com/2009-115/000-007
•	Item no.: 2009-115/000-012 WMB-Inline; for Smart Printer; 1500 pieces on roll; stretchable 5 - 5.2 mm; plain; snap-on type; orange	www.wago.com/2009-115/000-012
•	Item no.: 2009-115/000-017 WMB-Inline; for Smart Printer; 1500 pieces on roll; stretchable 5 - 5.2 mm; plain; snap-on type; light green	www.wago.com/2009-115/000-017
•	Item no.: 2009-115/000-023 WMB-Inline; for Smart Printer; 1500 pieces on roll; stretchable 5 - 5.2 mm; plain; snap-on type; green	www.wago.com/2009-115/000-023
•	Item no.: 2009-115/000-024 WMB-Inline; for Smart Printer; 1500 pieces on roll; stretchable 5 - 5.2 mm; plain; snap-on type; violet	www.wago.com/2009-115/000-024
	Item no.: 793-501 WMB marking card; as card; not stretchable; plain; snap-on type; white	www.wago.com/793-501
	Item no.: 793-501/000-002 WMB marking card; as card; not stretchable; plain; snap-on type; yellow	www.wago.com/793-501/000-002
	Item no.: 793-501/000-005 WMB marking card; as card; not stretchable; plain; snap-on type; red	www.wago.com/793-501/000-005
	Item no.: 793-501/000-006 WMB marking card; as card; not stretchable; plain; snap-on type; blue	www.wago.com/793-501/000-006
	Item no.: 793-501/000-007 WMB marking card; as card; not stretchable; plain; snap-on type; gray	www.wago.com/793-501/000-007

Subject to changes. Please also observe the further product documentation!



	Item no.: 793-501/000-012 WMB marking card; as card; not stretchable; plain; snap-on type; orange	www.wago.com/793-501/000-012
	Item no.: 793-501/000-017 WMB marking card; as card; not stretchable; plain; snap-on type; light green	www.wago.com/793-501/000-017
	Item no.: 793-501/000-023 WMB marking card; as card; not stretchable; plain; snap-on type; green	www.wago.com/793-501/000-023
	Item no.: 793-501/000-024 WMB marking card; as card; not stretchable; plain; snap-on type; violet	www.wago.com/793-501/000-024
	Item no.: 793-5501 WMB marking card; as card; for terminal block width 5 - 17.5 mm; stretchable 5 - 5.2 mm; plain; snap-on type; white	www.wago.com/793-5501
	Item no.: 793-5501/000-002 WMB marking card; as card; for terminal block width 5 - 17.5 mm; stretchable 5 - 5.2 mm; plain; snap-on type; yellow	www.wago.com/793-5501/000-002
	Item no.: 793-5501/000-005 WMB marking card; as card; for terminal block width 5 - 17.5 mm; stretchable 5 - 5.2 mm; plain; snap-on type; red	www.wago.com/793-5501/000-005
	Item no.: 793-5501/000-006 WMB marking card; as card; for terminal block width 5 - 17.5 mm; stretchable 5 - 5.2 mm; plain; snap-on type; blue	www.wago.com/793-5501/000-006
	Item no.: 793-5501/000-007 WMB marking card; as card; for terminal block width 5 - 17.5 mm; stretchable 5 - 5.2 mm; plain; snap-on type; gray	www.wago.com/793-5501/000-007
	Item no.: 793-5501/000-012 WMB marking card; as card; for terminal block width 5 - 17.5 mm; stretchable 5 - 5.2 mm; plain; snap-on type; orange	www.wago.com/793-5501/000-012
	Item no.: 793-5501/000-014 WMB marking card; as card; for terminal block width 5 - 17.5 mm; stretchable 5 - 5.2 mm; plain; snap-on type; brown	www.wago.com/793-5501/000-014
	Item no.: 793-5501/000-017 WMB marking card; as card; for terminal block width 5 - 17.5 mm; stretchable 5 - 5.2 mm; plain; snap-on type; green	www.wago.com/793-5501/000-017
	Item no.: 793-5501/000-023 WMB marking card; as card; for terminal block width 5 - 17.5 mm; stretchable 5 - 5.2 mm; plain; snap-on type; light green	www.wago.com/793-5501/000-023

Item no.: 793-5501/000-024

Subject to changes. Please also observe the further product documentation!

WAGO Corporation
 Germantown, WI 53022
 Phone: 1-800-DIN-RAIL (346-7245) | Fax: (262) 255-6222
 Email: info.us@wago.com | Web: www.wago.us



Do you have any questions about our products?
 We are always happy to take your call at +49 (571) 887-44222.

	WMB marking card; as card; for terminal block width 5 - 17.5 mm; stretchable 5 - 5.2 mm; plain; snap-on type; violet	www.wago.com/793-5501/000-024
---	--	--

Cover

	Item no.: 285-1178 Finger guard; touchproof cover protects unused conductor entries and jumper slots; for 185 mm ² high-current terminal blocks; yellow	www.wago.com/285-1178
--	--	--

Protective warning marker

	Item no.: 285-1176 Protective warning marker; yellow	www.wago.com/285-1176
	Item no.: 285-1177 Protective warning marker; with high-voltage symbol, black; yellow	www.wago.com/285-1177

Jumpers

	Item no.: 285-1171 Jumper; insulated; gray	www.wago.com/285-1171
---	--	--



Potential distribution

	Item no.: 285-1175 Power tap; for 185 mm ² high-current terminal blocks; 10,00 mm ² ; gray	www.wago.com/285-1175
---	--	--

Ferrules

	Item no.: 216-413 Ferrule; Sleeve for 25 mm ² / AWG 4; uninsulated; electro-tin plated; electrolytic copper; gastight crimped; acc. to DIN 46228, Part 1/08.92; silver-colored	www.wago.com/216-413
	Item no.: 216-414 Ferrule; Sleeve for 35 mm ² / AWG 2; uninsulated; electro-tin plated; electrolytic copper; gastight crimped; acc. to DIN 46228, Part 1/08.92; silver-colored	www.wago.com/216-414
	Item no.: 216-424 Ferrule; Sleeve for 35 mm ² / AWG 2; uninsulated; electro-tin plated; electrolytic copper; gastight crimped; acc. to DIN 46228, Part 1/08.92; silver-colored	www.wago.com/216-424
	Item no.: 216-425 Ferrule; Sleeve for 50 mm ² / AWG 1; uninsulated; electro-tin plated; electrolytic copper; gastight crimped; acc. to DIN 46228, Part 1/08.92	www.wago.com/216-425
	Item no.: 216-435 Ferrule; Sleeve for 50 mm ² / AWG 1; uninsulated; electro-tin plated; electrolytic copper; gastight crimped; acc. to DIN 46228, Part 1/08.92	www.wago.com/216-435

Tools

	Item no.: 285-172 Allen wrench; with a partially insulated shaft; green	www.wago.com/285-172
	Item no.: 285-173 Allen wrench; with a partially insulated shaft; with anti-rotation protection; green	www.wago.com/285-173

Downloads

Documentation

Subject to changes. Please also observe the further product documentation!

WAGO Corporation
 Germantown, WI 53022
 Phone: 1-800-DIN-RAIL (346-7245) | Fax: (262) 255-6222
 Email: info.us@wago.com | Web: www.wago.us

Do you have any questions about our products?
 We are always happy to take your call at +49 (571) 887-44222.

Additional Information

Technical explanations

2019 Apr 3

pdf
2.2 MB

[Download](#)

CAD files

CAD data

2D/3D Models 285-1163

[URL](#)

[Download](#)

CAE data

ZUKEN Portal 285-1163

[URL](#)

[Download](#)

EPLAN Data Portal 285-1163

[URL](#)

[Download](#)

Environmental Product Compliance

Compliance Search

Environmental Product Compliance 285-1163

[URL](#)

[Download](#)

2-conductor through terminal block; 185 mm²; suitable for Ex e II applications; lateral marker slots; with fixing flanges; POWER CAGE CLAMP; 185,00 mm²; light gray

Installation Notes

Installation

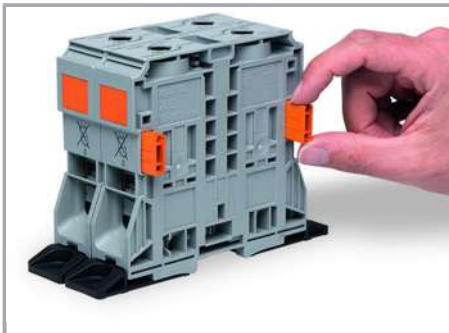

Optionally, insert block-to-block connector (285-1179) into housing slot.

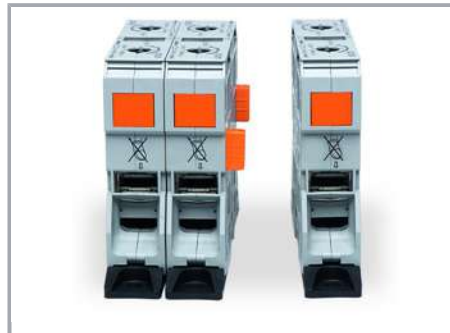

Align and snap high-current, through terminal blocks together.

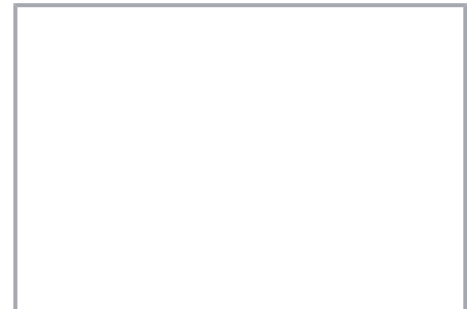

Subject to changes. Please also observe the further product documentation!

WAGO Corporation
Germantown, WI 53022
Phone: 1-800-DIN-RAIL (346-7245) | Fax: (262) 255-6222
Email: info.us@wago.com | Web: www.wago.us

Do you have any questions about our products?
We are always happy to take your call at +49 (571) 887-44222.

Data sheet | Item number: 285-1163

www.wago.com/285-1163



Secure the terminal block to a mounting plate using two M8 cylinder-head screws and appropriate washers.

Product family

POWER CAGE CLAMP

[Show all products from the family](#)

Subject to changes. Please also observe the further product documentation!

WAGO Corporation
Germantown, WI 53022
Phone: 1-800-DIN-RAIL (346-7245) | Fax: (262) 255-6222
Email: info.us@wago.com | Web: www.wago.us

Do you have any questions about our products?
We are always happy to take your call at +49 (571) 887-44222.