

Data sheet | Item number: 286-312/004-000

Relay module; Nominal input voltage: 24 VDC; 2 changeover contacts;
Limiting continuous current: 5 A; Path; Red status indicator; Module width: 20
mm; gray

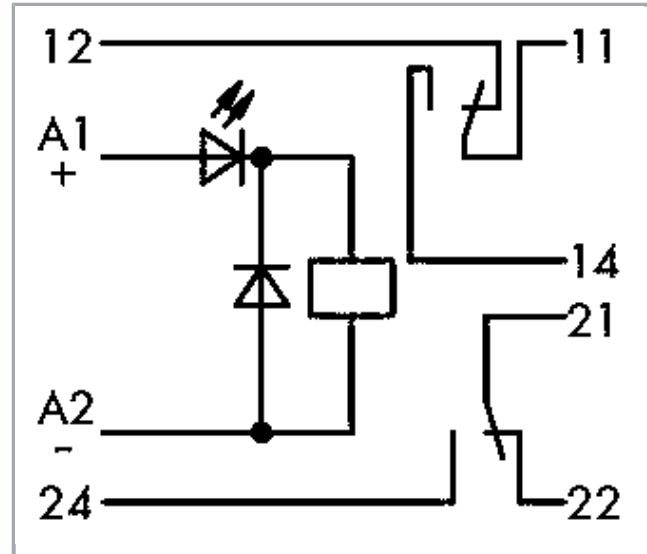

www.wago.com/286-312_004-000



RoHS Compliant

BOMcheck.net

Color: ■

Subject to changes. Please also observe the further product documentation!

WAGO Kontakttechnik GmbH & Co. KG
Hansastr. 27
32423 Minden
Phone: +49571 887-0 | Fax: +49571 887-169
Email: info.de@wago.com | Web: www.wago.com

Do you have any questions about our products?
We are always happy to take your call at +49 (571) 887-44222.

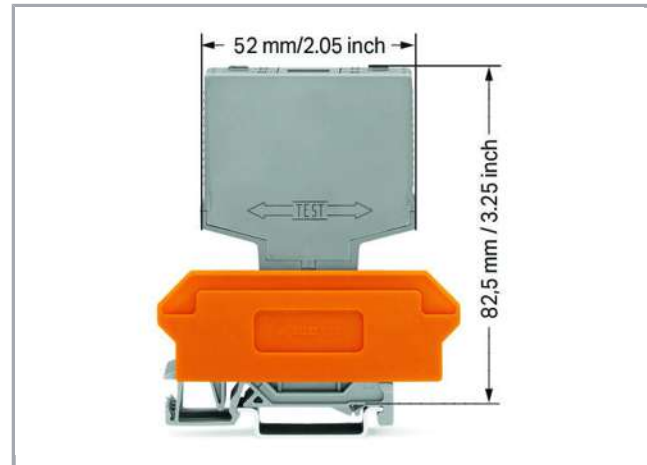
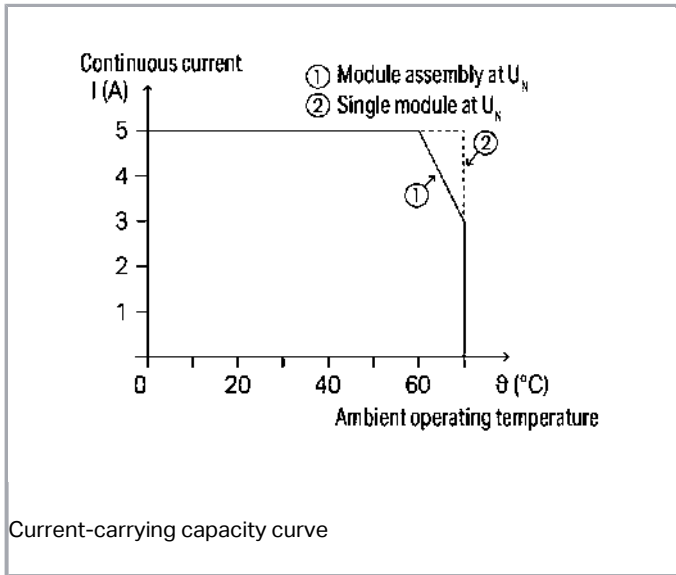

Data

Technical Data

Control circuit

Nominal input voltage U_N	DC 24 V
Input voltage range	-30 ... +25 %
Nominal input current at U_N	21,8 mA

Load circuit:

Number of changeover/switchover contacts	2
Contact material (relay)	AgNi 0.15
Limiting continuous current	5 A
Max. switching voltage	AC 250 V
Max. switching power (resistive)	AC 1750 VA
Pull-in time (typ.)	18 ms
Drop-out time (typ.)	3 ms
Bounce time (typ.)	2 ms

Signaling

Status indication	Red LED
-------------------	---------

Subject to changes. Please also observe the further product documentation!

Safety and protection:

Rated voltage	250 V
Rated impulse voltage	4 kV
Pollution degree	2
Dielectric strength, control/load circuit (AC, 1 min)	2 kVrms
Dielectric strength open contact (AC, 1 min)	1 kVrms
Dielectric strength, load/load circuit (AC, 1 min)	1,5 kVrms
Protection class	IP20

Geometrical Data

Width	20 mm / 0.787 inch
Height from upper-edge of DIN-35 rail	82,5 mm / 3.248 inch
Depth	52 mm / 2.047 inch

Mechanical data

Type of mounting	Pluggable module for receptacle terminal blocks
------------------	---

Material Data

Color	gray
Fire load	0.612 MJ
Weight	39.8 g

Environmental Requirements

Surrounding air (operating) temperature at U_N	-25 ... 70 °C
Surrounding air (storage) temperature	-25 ... 70 °C
Processing temperature	-25 ... +50 °C

Standards and specifications

Standards/specifications	EN 60664-1
--------------------------	------------

Commercial data

Product Group	6 (Interface Electronics)
Packaging type	BOX
Country of origin	DE

Subject to changes. Please also observe the further product documentation!



GTIN	4055143105002
------	---------------

Customs Tariff No.	85364900990
--------------------	-------------







Counterpart

Compatible products

General accessories

	Item no.: 280-628 Terminal block for pluggable modules; 8-pole; with 4-conductor terminal blocks; with orange separator; www.wago.com/280-628 for DIN-rail 35 x 15 and 35 x 7.5; 2.5 mm ² ; CAGE CLAMP®; 2,50 mm ² ; gray
	Item no.: 280-638 Terminal block for pluggable modules; 8-pole; with 2-conductor terminal blocks; with orange separator; www.wago.com/280-638 for DIN-rail 35 x 15 and 35 x 7.5; 2.5 mm ² ; CAGE CLAMP®; 2,50 mm ² ; gray
	Item no.: 280-764 Terminal block for pluggable modules; 8-pole; with 4-conductor terminal blocks; with marker carrier; www.wago.com/280-764 with orange separator; for DIN-rail 35 x 15 and 35 x 7.5; 2.5 mm ² ; CAGE CLAMP®; 2,50 mm ² ; gray

Marking accessories

	Item no.: 209-701 WSB marking card; as card; not stretchable; plain; snap-on type; white www.wago.com/209-701
	Item no.: 209-701/000-002 WSB marking card; as card; not stretchable; plain; snap-on type; yellow www.wago.com/209-701/000-002
	Item no.: 209-701/000-005 WSB marking card; as card; not stretchable; plain; snap-on type; red www.wago.com/209-701/000-005
	Item no.: 209-701/000-006 WSB marking card; as card; not stretchable; plain; snap-on type; blue www.wago.com/209-701/000-006
	Item no.: 209-701/000-007 WSB marking card; as card; not stretchable; plain; snap-on type; gray www.wago.com/209-701/000-007
	Item no.: 209-701/000-012 WSB marking card; as card; not stretchable; plain; snap-on type; orange www.wago.com/209-701/000-012
	Item no.: 209-701/000-017 WSB marking card; as card; not stretchable; plain; snap-on type; light green www.wago.com/209-701/000-017

Subject to changes. Please also observe the further product documentation!

WAGO Kontakttechnik GmbH & Co. KG
Hansastr. 27
32423 Minden
Phone: +49571 887-0 | Fax: +49571 887-169
Email: info.de@wago.com | Web: www.wago.com

Do you have any questions about our products?
We are always happy to take your call at +49 (571) 887-44222.



Item no.: 209-701/000-023

WSB marking card; as card; not stretchable; plain; snap-on type; green

www.wago.com/209-701/000-023



Item no.: 209-701/000-024

WSB marking card; as card; not stretchable; plain; snap-on type; violet

www.wago.com/209-701/000-024

Downloads

Documentation

Bid Text

286-312/004-000 doc - Datei	Mar 27, 2015	doc 27.6 kB	Download
--------------------------------	--------------	----------------	----------

286-312/004-000 X81 - Datei	Feb 19, 2019	xml 3.9 kB	Download
--------------------------------	--------------	---------------	----------

Instruction Leaflet

		pdf 1.3 MB	Download
--	--	---------------	----------

Additional Information

Disposal; Electrical and electronic equipment, Packaging	V 1.0.0	pdf 265.8 kB	Download
--	---------	-----------------	----------

CAD/CAE-Data

CAE data

WSCAD Universe 286-312/004-000		URL	Download
--------------------------------	--	-----	----------

Installation Notes

Assembly

Subject to changes. Please also observe the further product documentation!

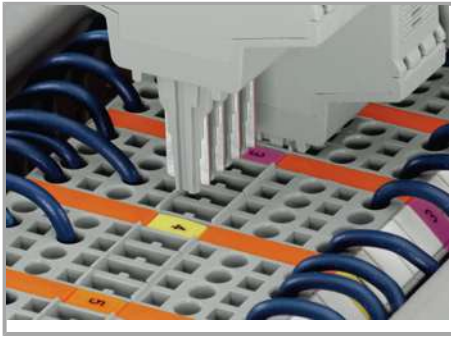

Coding ensures correct polarity

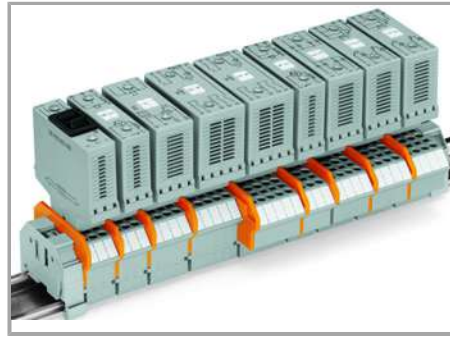

Pluggable electronic modules, for application on 2- or 4-conductor carrier terminal blocks

Marking



Marking using WMB Multi markers

Testing



Easy testing at touchproof contacts

Subject to changes. Please also observe the further product documentation!