

Data sheet | Item number: 286-665

Current flow monitoring module; AC currents; Monitoring range: 1 A – 10 A; 1 changeover contact; light gray

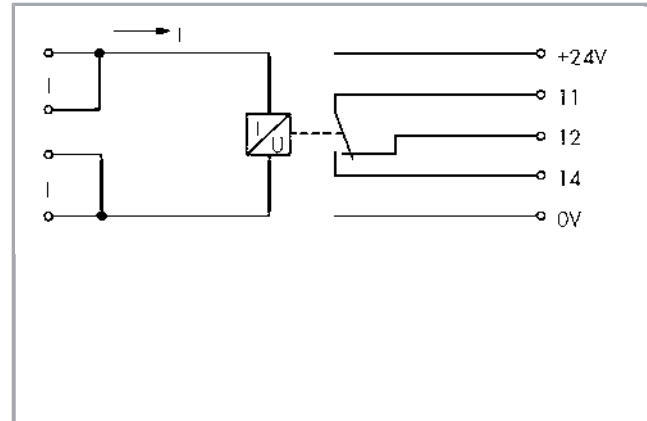

www.wago.com/286-665

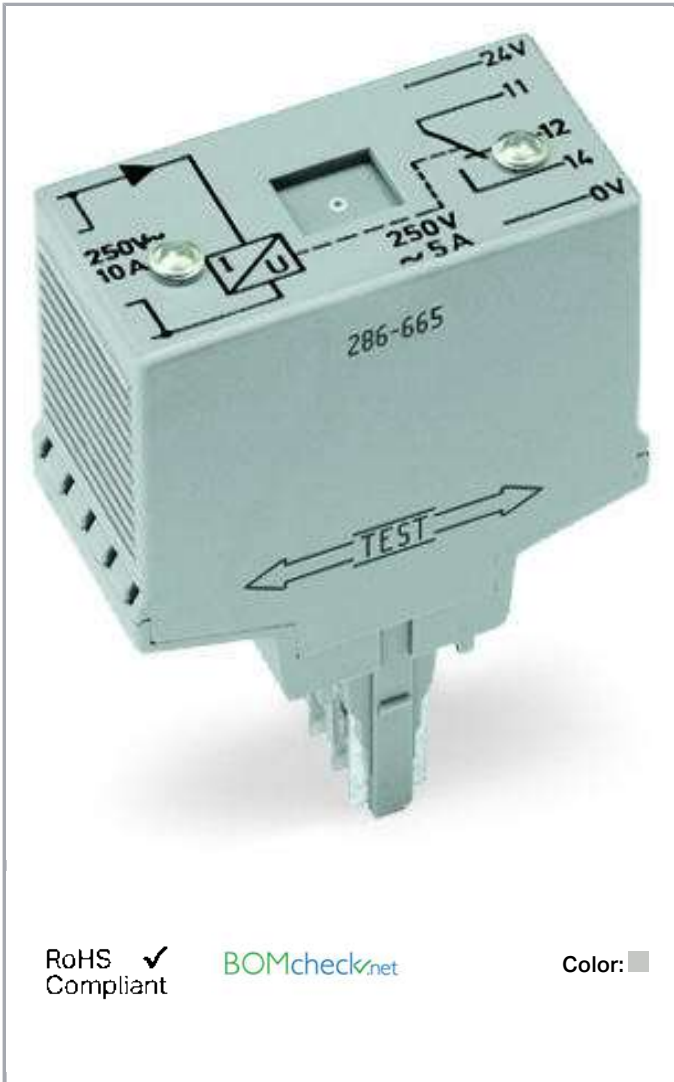

RoHS Compliant

[BOMcheck.net](https://www.bomcheck.net)

Color: ■

Subject to changes. Please also observe the further product documentation!

WAGO Kontakttechnik GmbH & Co. KG
Hansastr. 27
32423 Minden
Phone: +49571 887-0 | Fax: +49571 887-169
Email: info.de@wago.com | Web: www.wago.com

Do you have any questions about our products?
We are always happy to take your call at +49 (571) 887-44222.

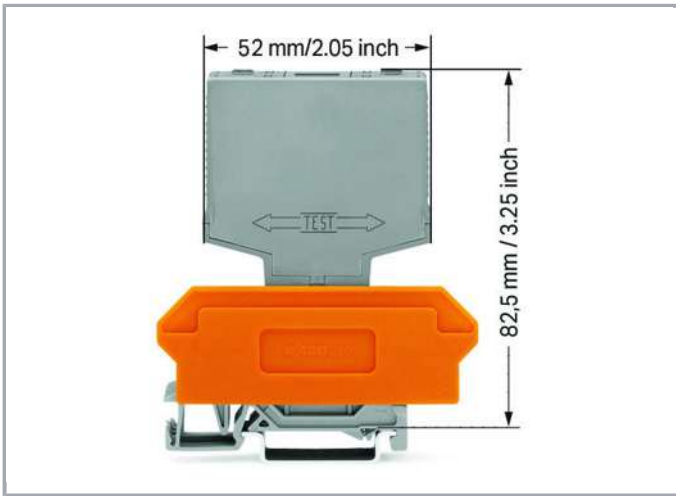

Data

Electrical data

Nominal operating voltage	DC 24 V
Current consumption at supply voltage	≤ 28 mA
Voltage drop at input	23 ... 850 mV
Max. measuring span	1 ... 10 AAC
Min. switching threshold (adjustable)	1 A
Response time	200 ms
Number of changeover/switchover contacts	1
Number of break contacts/switch off contacts	1
Limiting continuous current	5 A
Max. switching voltage	AC 250 V
Max. switching power (resistive)	AC 1250 VA
Status indication	Red LED; Energized relay (current < switching threshold)

Safety and protection:

Rated voltage	250 V
Rated impulse voltage	4 kV
Pollution degree	2
Dielectric strength input/output (AC, 1 min)	1.5

Geometrical Data

Height from upper-edge of DIN-35 rail	82,5 mm / 3.25 inch
Depth	52 mm / 2.047 inch

Subject to changes. Please also observe the further product documentation!

Mechanical data

Type of mounting	Pluggable module for receptacle terminal blocks
Housing design	Plug for carrier terminal blocks

Material Data

Color	light gray
Weight	58 g

Environmental Requirements

Surrounding air (operating) temperature	-25 ... 40 °C
Surrounding air (storage) temperature	-40 ... 70 °C



Commercial data

Product Group	6 (Interface Electronics)
Packaging type	BOX
Country of origin	DE
GTIN	4050821254850
Customs Tariff No.	85364900990

Counterpart

Compatible products

General accessories

	Item no.: 280-629 Terminal block for pluggable modules; 10-pole; with 4-conductor terminal blocks; with orange separator; for DIN-rail 35 x 15 and 35 x 7.5; 2.5 mm ² ; CAGE CLAMP®; 2,50 mm ² ; gray	www.wago.com/280-629
	Item no.: 280-639 Terminal block for pluggable modules; 10-pole; with 2-conductor terminal blocks; with orange separator; for DIN-rail 35 x 15 and 35 x 7.5; 2.5 mm ² ; CAGE CLAMP®; 2,50 mm ² ; gray	www.wago.com/280-639
	Item no.: 280-765 Terminal block for pluggable modules; 10-pole; with 4-conductor terminal blocks; with marker carrier; with orange separator; for DIN-rail 35 x 15 and 35 x 7.5; 2.5 mm ² ; CAGE CLAMP®; 2,50 mm ² ; gray	www.wago.com/280-765

Marking accessories

	Item no.: 209-701 WSB marking card; as card; not stretchable; plain; snap-on type; white	www.wago.com/209-701
--	--	--

Subject to changes. Please also observe the further product documentation!



Item no.: 209-701/000-002
WSB marking card; as card; not stretchable; plain; snap-on type; yellow

www.wago.com/209-701/000-002



Item no.: 209-701/000-005
WSB marking card; as card; not stretchable; plain; snap-on type; red

www.wago.com/209-701/000-005



Item no.: 209-701/000-006
WSB marking card; as card; not stretchable; plain; snap-on type; blue

www.wago.com/209-701/000-006



Item no.: 209-701/000-007
WSB marking card; as card; not stretchable; plain; snap-on type; gray

www.wago.com/209-701/000-007



Item no.: 209-701/000-012
WSB marking card; as card; not stretchable; plain; snap-on type; orange

www.wago.com/209-701/000-012



Item no.: 209-701/000-017
WSB marking card; as card; not stretchable; plain; snap-on type; light green

www.wago.com/209-701/000-017



Item no.: 209-701/000-023
WSB marking card; as card; not stretchable; plain; snap-on type; green

www.wago.com/209-701/000-023



Item no.: 209-701/000-024
WSB marking card; as card; not stretchable; plain; snap-on type; violet

www.wago.com/209-701/000-024

Downloads

Documentation

Bid Text

286-665 doc - Datei	Apr 2, 2015	doc 25.6 kB	Download
------------------------	-------------	----------------	----------

286-665 X81 - Datei	Feb 19, 2019	xml 3.8 kB	Download
------------------------	--------------	---------------	----------

Instruction Leaflet

		pdf 1.3 MB	Download
--	--	---------------	----------

Additional Information

Disposal; Electrical and electronic equipment, Packaging	V 1.0.0	pdf	Download
--	---------	-----	----------

Subject to changes. Please also observe the further product documentation!

WAGO Kontakttechnik GmbH & Co. KG
Hansastr. 27
32423 Minden
Phone: +49571 887-0 | Fax: +49571 887-169
Email: info.de@wago.com | Web: www.wago.com

Do you have any questions about our products?
We are always happy to take your call at +49 (571) 887-44222.



265.8 kB

CAD/CAE-Data

CAD data

2D/3D Models 286-665	URL	Download
----------------------	---------------------	--------------------------

CAE data

WSCAD Universe 286-665	URL	Download
------------------------	---------------------	--------------------------

Installation Notes

Subject to changes. Please also observe the further product documentation!

WAGO Kontakttechnik GmbH & Co. KG
Hansastr. 27
32423 Minden
Phone: +49571 887-0 | Fax: +49571 887-169
Email: info.de@wago.com | Web: www.wago.com

Do you have any questions about our products?
We are always happy to take your call at +49 (571) 887-44222.