

## Data sheet | Item number: 286-835/115-000

Pluggable module; Single-stage suppression for 3-wire data; No interruption of current flow when changing module; 115 VAC

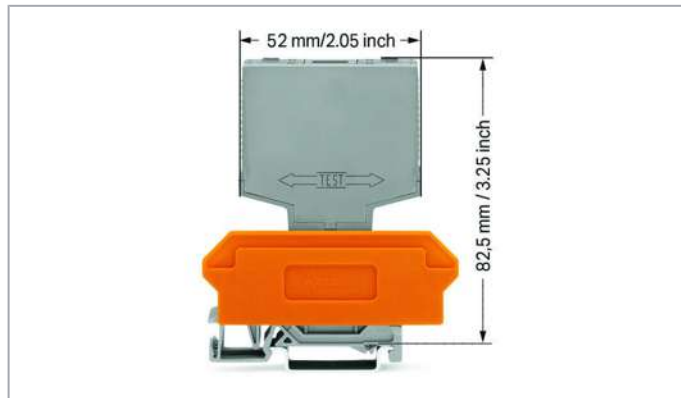

[www.wago.com/286-835\\_115-000](http://www.wago.com/286-835_115-000)

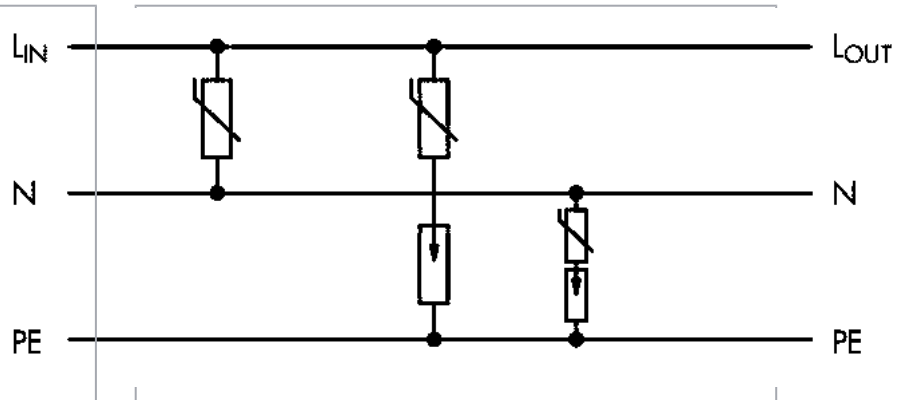

### Item description

#### Short description:

Two- and three-stage pluggable surge suppression modules (286 Series) for data, measurement, control, or power circuits are also available.

#### Features:

- Protect your system against overvoltage
- Slim, space-saving design
- Control operational costs by preventing expensive, unplanned downtime
- High operational reliability and system uptime

#### Note:

Subject to changes. Please also observe the further product documentation!

WAGO Corporation  
Germantown, WI 53022  
Phone: 1-800-DIN-RAIL (346-7245) | Fax: (262) 255-6222  
Email: [info.us@wago.com](mailto:info.us@wago.com) | Web: [www.wago.us](http://www.wago.us)

Do you have any questions about our products?  
We are always happy to take your call at {0}.

For isolation measurement, the ground contact at the transient suppression module must be disconnected.

## Data

### Electrical data

Nominal operating voltage	AC 115 V
Operating voltage	≤ AC 150 V
Nominal discharge current (line/line)	1 kA
Nominal discharge current (line/protected ground)	1 kA
Surge current (line/line)	≤ 400 V
Surge current (line/protected ground)	≤ 1000 V
Response time (line/line)	≤ 15 ns
Response time (line/protected ground)	≤ 1 ms

### Physical data

Width	17 mm / 0.669 inch
-------	--------------------

### Material Data

Color	gray
-------	------

### Environmental Requirements

Surrounding air temperature (operation)	-25 ... 85 °C
---	---------------

### Commercial data

Product Group	6 (Interface Electronics)
Packaging type	BOX

### Counterpart

### Compatible products

#### Marking accessories

















Item no.: 209-700/209-124

WSB marking card; as card; MARKED; F11, ..., F20 (10x); not stretchable; Vertical marking; snap-on type; white

[www.wago.com/209-700/209-124](http://www.wago.com/209-700/209-124)





Item no.: 209-700/209-125

Subject to changes. Please also observe the further product documentation!

	WSB marking card; as card; MARKED; F21, ..., F30 (10x); not stretchable; Vertical marking; snap-on type; white	<a href="http://www.wago.com/209-700/209-125">www.wago.com/209-700/209-125</a>
	<b>Item no.: 209-700/209-126</b> WSB marking card; as card; MARKED; F31, ..., F40 (10x); not stretchable; Vertical marking; snap-on type; white	<a href="http://www.wago.com/209-700/209-126">www.wago.com/209-700/209-126</a>
	<b>Item no.: 209-700/209-127</b> WSB marking card; as card; MARKED; F41, ..., F50 (10x); not stretchable; Vertical marking; snap-on type; white	<a href="http://www.wago.com/209-700/209-127">www.wago.com/209-700/209-127</a>
	<b>Item no.: 209-701</b> WSB marking card; as card; not stretchable; plain; snap-on type; white	<a href="http://www.wago.com/209-701">www.wago.com/209-701</a>
	<b>Item no.: 209-701/000-002</b> WSB marking card; as card; not stretchable; plain; snap-on type; yellow	<a href="http://www.wago.com/209-701/000-002">www.wago.com/209-701/000-002</a>
	<b>Item no.: 209-701/000-005</b> WSB marking card; as card; not stretchable; plain; snap-on type; red	<a href="http://www.wago.com/209-701/000-005">www.wago.com/209-701/000-005</a>
	<b>Item no.: 209-701/000-006</b> WSB marking card; as card; not stretchable; plain; snap-on type; blue	<a href="http://www.wago.com/209-701/000-006">www.wago.com/209-701/000-006</a>
	<b>Item no.: 209-701/000-007</b> WSB marking card; as card; not stretchable; plain; snap-on type; gray	<a href="http://www.wago.com/209-701/000-007">www.wago.com/209-701/000-007</a>
	<b>Item no.: 209-701/000-012</b> WSB marking card; as card; not stretchable; plain; snap-on type; orange	<a href="http://www.wago.com/209-701/000-012">www.wago.com/209-701/000-012</a>
	<b>Item no.: 209-701/000-017</b> WSB marking card; as card; not stretchable; plain; snap-on type; light green	<a href="http://www.wago.com/209-701/000-017">www.wago.com/209-701/000-017</a>
	<b>Item no.: 209-701/000-023</b> WSB marking card; as card; not stretchable; plain; snap-on type; green	<a href="http://www.wago.com/209-701/000-023">www.wago.com/209-701/000-023</a>
	<b>Item no.: 209-701/000-024</b> WSB marking card; as card; not stretchable; plain; snap-on type; violet	<a href="http://www.wago.com/209-701/000-024">www.wago.com/209-701/000-024</a>
	<b>Item no.: 209-702</b> WSB marking card; as card; MARKED; 1 ... 10 (10x); not stretchable; Vertical marking; snap-on type; white	<a href="http://www.wago.com/209-702">www.wago.com/209-702</a>
	<b>Item no.: 209-703</b> WSB marking card; as card; MARKED; 11 ... 20 (10x); not stretchable; Vertical marking; snap-on type; white	<a href="http://www.wago.com/209-703">www.wago.com/209-703</a>

Subject to changes. Please also observe the further product documentation!



	<b>Item no.: 209-704</b> WSB marking card; as card; MARKED; 21 ... 30 (10x); not stretchable; Vertical marking; snap-on type; white	<a href="http://www.wago.com/209-704">www.wago.com/209-704</a>
	<b>Item no.: 209-705</b> WSB marking card; as card; MARKED; 31 ... 40 (10x); not stretchable; Vertical marking; snap-on type; white	<a href="http://www.wago.com/209-705">www.wago.com/209-705</a>
	<b>Item no.: 209-706</b> WSB marking card; as card; MARKED; 41 ... 50 (10x); not stretchable; Vertical marking; snap-on type; white	<a href="http://www.wago.com/209-706">www.wago.com/209-706</a>
	<b>Item no.: 209-707</b> WSB marking card; as card; MARKED; 51 ... 100 (2x); not stretchable; Vertical marking; snap-on type; white	<a href="http://www.wago.com/209-707">www.wago.com/209-707</a>

## Downloads

### Documentation

#### Additional Information

Disposal; Electrical and electronic equipment, Packaging	V 1.0.0	pdf 265.8 kB	Download
--	---------	-----------------	----------

## Installation Notes

Subject to changes. Please also observe the further product documentation!

WAGO Corporation  
Germantown, WI 53022  
Phone: 1-800-DIN-RAIL (346-7245) | Fax: (262) 255-6222  
Email: [info.us@wago.com](mailto:info.us@wago.com) | Web: [www.wago.us](http://www.wago.us)

Do you have any questions about our products?  
We are always happy to take your call at {0}.