

Data sheet | Item number: 286-895

Switching module; with changeover rocker switch; Switching voltage: 250 VAC; Switching current: 6 A; gray

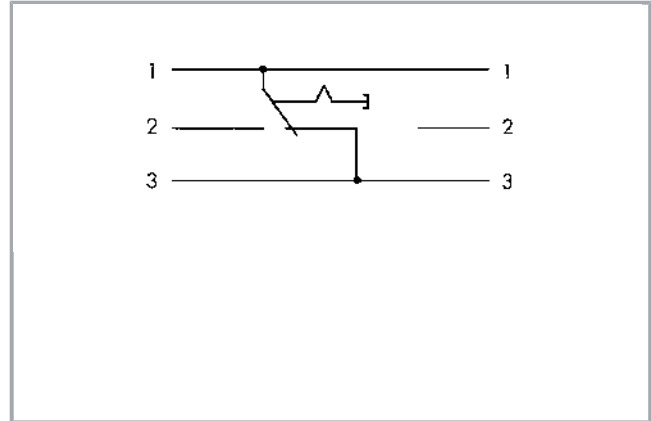

www.wago.com/286-895



Subject to changes. Please also observe the further product documentation!

WAGO Kontakttechnik GmbH & Co. KG
Hansastr. 27
32423 Minden
Phone: +49571 887-0 | Fax: +49571 887-169
Email: info.de@wago.com | Web: www.wago.com

Do you have any questions about our products?
We are always happy to take your call at +49 (571) 887-44222.

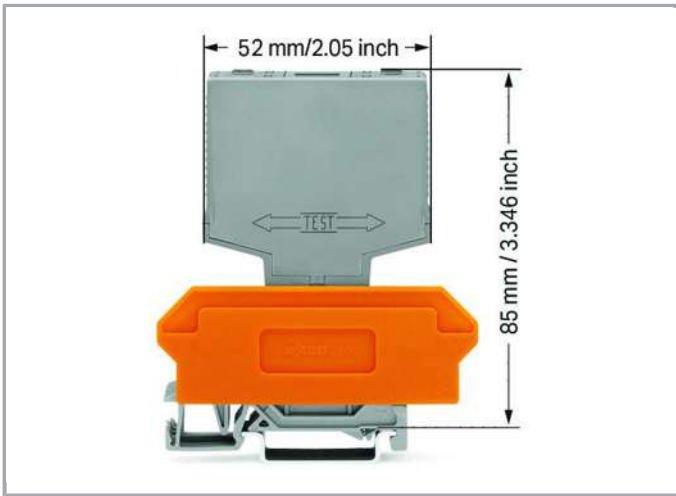

Data

Electrical data

Max. switching current (resistive)	6 A
Max. switching voltage	AC 250 V; DC 24 V
Contact gap	≥ 3 mm
Electrical life (N.O.; resistive load; 23 °C)	50 x 10 ³ switching operations

Geometrical Data

Width	15 mm / 0.591 inch
Height from upper-edge of DIN-35 rail	85 mm / 3.346 inch
Depth	52 mm / 2.047 inch

Mechanical data

Type of mounting	Pluggable module for carrier terminal blocks
Housing design	Pluggable module for terminal blocks

Material Data

Color	gray
Fire load	0.404 MJ
Weight	20.5 g

Environmental Requirements

Surrounding air (operating) temperature at U _N	-20 ... 40 °C
---	---------------

Subject to changes. Please also observe the further product documentation!









Commercial data

Product Group	6 (Interface Electronics)
Packaging type	BOX
Country of origin	DE
GTIN	4045454399801
Customs Tariff No.	85365080900

Counterpart

Compatible products

Marking accessories

	Item no.: 209-701 WSB marking card; as card; not stretchable; plain; snap-on type; white	www.wago.com/209-701
	Item no.: 209-701/000-002 WSB marking card; as card; not stretchable; plain; snap-on type; yellow	www.wago.com/209-701/000-002
	Item no.: 209-701/000-005 WSB marking card; as card; not stretchable; plain; snap-on type; red	www.wago.com/209-701/000-005
	Item no.: 209-701/000-006 WSB marking card; as card; not stretchable; plain; snap-on type; blue	www.wago.com/209-701/000-006
	Item no.: 209-701/000-007 WSB marking card; as card; not stretchable; plain; snap-on type; gray	www.wago.com/209-701/000-007
	Item no.: 209-701/000-012 WSB marking card; as card; not stretchable; plain; snap-on type; orange	www.wago.com/209-701/000-012
	Item no.: 209-701/000-017 WSB marking card; as card; not stretchable; plain; snap-on type; light green	www.wago.com/209-701/000-017
	Item no.: 209-701/000-023 WSB marking card; as card; not stretchable; plain; snap-on type; green	www.wago.com/209-701/000-023
	Item no.: 209-701/000-024 WSB marking card; as card; not stretchable; plain; snap-on type; violet	www.wago.com/209-701/000-024

Subject to changes. Please also observe the further product documentation!

General accessories

**Item no.: 280-609**

Terminal block for pluggable modules; 6-pole; with 4-conductor terminal blocks; with orange separator; www.wago.com/280-609 for DIN-rail 35 x 15 and 35 x 7.5; 2.5 mm²; CAGE CLAMP®; 2,50 mm²; gray

**Item no.: 280-619**

Terminal block for pluggable modules; 6-pole; with 2-conductor terminal blocks; with orange separator; www.wago.com/280-619 for DIN-rail 35 x 15 and 35 x 7.5; 2.5 mm²; CAGE CLAMP®; 2,50 mm²; gray

**Item no.: 280-763**

Terminal block for pluggable modules; 6-pole; with 4-conductor terminal blocks; with marker carrier; www.wago.com/280-763 with orange separator; for DIN-rail 35 x 15 and 35 x 7.5; 2.5 mm²; CAGE CLAMP®; 2,50 mm²; gray

Downloads**Documentation****Bid Text**

286-895 doc - Datei	Apr 1, 2015	doc 24.6 kB	Download
------------------------	-------------	----------------	----------

286-895 X81 - Datei	Feb 19, 2019	xml 3.1 kB	Download
------------------------	--------------	---------------	----------

Instruction Leaflet

		pdf 1.3 MB	Download
--	--	---------------	----------

Additional Information

Disposal; Electrical and electronic equipment, Packaging	V 1.0.0	pdf 265.8 kB	Download
--	---------	-----------------	----------

CAD/CAE-Data**CAD data**

2D/3D Models 286-895		URL	Download
----------------------	--	-----	----------

CAE data

WSCAD Universe 286-895		URL	Download
------------------------	--	-----	----------

Installation Notes

Subject to changes. Please also observe the further product documentation!