

**Data sheet | Item number: 765-1104/100-000 NEW**

8-channel digital input/output; Profinet; 8 Configurable DIO; DC 24 V / 2.0 A;  
4xM12 connection; SlimLine



[www.wago.com/765-1104\\_100-0000](http://www.wago.com/765-1104_100-0000)



RoHS Compliant

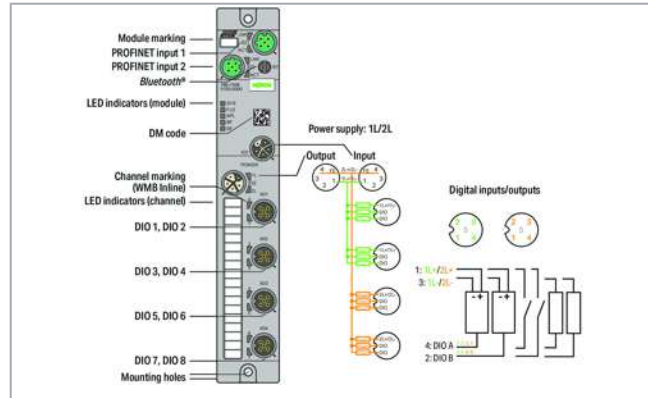

**Data**

**Technical Data**

**Feldbus**

|   |  |
|---|--|
| Communication                                 | PROFINET   |
| Connection technology: communication/fieldbus | 2 x D-coded M12; 4-pole                            |
| Interface standard                            | 10BASE-T/100BASE-TX; potential-free                |
| Autonegotiation; Autocrossover                | yes  |
| PROFINET IO properties                        | PROFINET IO device; 2-port switch, LLDP, MRP, SNMP |

**Gerätefunktionen**

|                  |  |
|------------------|--|
| Parameter        | Input filter<br>Output current<br>Temperature        |
| Diagnostics      | Undervoltage; Overcurrent; Overload; Overtemperature |
| Device functions | Bluetooth®<br>OPC UA server                          |
| Visualization    | Android/iOS app                                      |

Subject to changes. Please also observe the further product documentation!

WAGO Corporation  
Germantown, WI 53022  
Phone: 1-800-DIN-RAIL (346-7245) | Fax: (262) 255-6222  
Email: [info.us@wago.com](mailto:info.us@wago.com) | Web: [www.wago.us](http://www.wago.us)

Do you have any questions about our products?  
We are always happy to take your call at {0}.



## Digitalein-/ausgänge

|   |                         |
|---|-------------------------|
| Number of digital inputs                | 8                       |
| Number of digital outputs               | 8                       |
| Connection technology: inputs / outputs | 4 x A-coded M12; 5-pole |
| Input characteristic                    | High-side switching     |
| Input filter                            | 0.2 ... 20 ms           |
| Input characteristic                    | Type 3, per IEC 61131-2 |
| Output current (per channel)            | typ. 2 A for DO         |

## Versorgung Modul

|                               |  |
|-------------------------------|--|
| Connection technology: supply | 2 x L-coded M12; 5-pole                                |
| Supply voltage                | DC 24 V (18 ... 31.2 V); 1L/2L                         |
| Power consumption (max.)      | 16000 mA   |
| Power consumption (note)      | per supply line; overload- and short-circuit-protected |
| Reverse voltage protection    | Yes  |

## Geometrical Data

|        |                     |
|--------|---------------------|
| Width  | 35 mm / 1.378 inch  |
| Height | 30 mm / 1.181 inch  |
| Depth  | 210 mm / 8.268 inch |

## Mechanical Data

|                    |       |
|--------------------|-------|
| Weight             | 380 g |
| Conformity marking | CE    |

## Environmental Requirements

|  |   |
|--|---|
| Surrounding air temperature (operation)  | -25 ... 70 °C                           |
| Surrounding air temperature (storage)    | -40 ... 80 °C                           |
| Protection type                          | IP67                                    |
| Protection class                         | III per EN 61140, IEC 61140, VDE 0140-1 |
| Operating altitude                       | 0 ... 2000 m                            |
| Pollution degree (5)                     | 3 (EN 60664-1)                          |
| Overvoltage category                     | II (EN 60664-1)                         |
| Relative humidity (without condensation) | 95 %                                    |
| Vibration resistance                     | 5g per IEC 60068-2-6                    |

Subject to changes. Please also observe the further product documentation!

WAGO Corporation  
 Germantown, WI 53022  
 Phone: 1-800-DIN-RAIL (346-7245) | Fax: (262) 255-6222  
 Email: [info.us@wago.com](mailto:info.us@wago.com) | Web: [www.wago.us](http://www.wago.us)

Do you have any questions about our products?  
 We are always happy to take your call at {0}.

|                              |  |
|------------------------------|--|
| Shock resistance             | Short-term: 50g/11 ms/half-sine per IEC 60068-2-27; Long-term: 30g/6 ms/half-sine per IEC 60068-2-29 |
| EMC immunity to interference | per EN 61000-6-2   |
| EMC emission of interference | per EN 61000-6-4   |



## Commercial data

|                       |               |
|-----------------------|---------------|
| PU (SPU)              | 1 Stück       |
| Packaging type        | BOX           |
| Country of origin     | DE            |
| GTIN                  | 4055143949774 |
| Customs tariff number | 85371098990   |













## Counterpart

## Compatible products













### wiring and connectors

|  |  |  |
|--|--|--|
|   | <b>Item no.: 756-1201/060-020</b><br>ETHERNET cable; 4-pole; M12 plug, axial; Length: 2 m        | <a href="http://www.wago.com/756-1201/060-020">www.wago.com/756-1201/060-020</a> |
|  | <b>Item no.: 756-1201/060-050</b><br>ETHERNET cable; 4-pole; M12 socket, straight; Length: 5 m   | <a href="http://www.wago.com/756-1201/060-050">www.wago.com/756-1201/060-050</a> |
|  | <b>Item no.: 756-1201/060-100</b><br>ETHERNET cable; 4-pole; M12 socket, straight; Length: 10 m  | <a href="http://www.wago.com/756-1201/060-100">www.wago.com/756-1201/060-100</a> |
|  | <b>Item no.: 756-1201/060-200</b><br>ETHERNET cable; 4-pole; M12 socket, straight; Length: 20 m  | <a href="http://www.wago.com/756-1201/060-200">www.wago.com/756-1201/060-200</a> |
|  | <b>Item no.: 756-1202/060-020</b><br>ETHERNET cable; 4-pole; M12 plug, right angle; Length: 2 m  | <a href="http://www.wago.com/756-1202/060-020">www.wago.com/756-1202/060-020</a> |
|  | <b>Item no.: 756-1202/060-050</b><br>ETHERNET cable; 4-pole; M12 plug, right angle; Length: 5 m  | <a href="http://www.wago.com/756-1202/060-050">www.wago.com/756-1202/060-050</a> |
|  | <b>Item no.: 756-1202/060-100</b><br>ETHERNET cable; 4-pole; M12 plug, right angle; Length: 10 m | <a href="http://www.wago.com/756-1202/060-100">www.wago.com/756-1202/060-100</a> |













Subject to changes. Please also observe the further product documentation!

|  |  |  |
|--|--|--|
|    | <b>Item no.: 756-1202/060-200</b><br>ETHERNET cable; 4-pole; M12 plug, right angle; Length: 20 m   | <a href="http://www.wago.com/756-1202/060-200">www.wago.com/756-1202/060-200</a> |
|    | <b>Item no.: 756-1203/060-020</b><br>ETHERNET cable; 4-pole; M12 plug, axial; M12 plug, axial; Length: 2 m   | <a href="http://www.wago.com/756-1203/060-020">www.wago.com/756-1203/060-020</a> |
|    | <b>Item no.: 756-1203/060-050</b><br>ETHERNET cable; 4-pole; M12 plug, axial; M12 plug, axial; Length: 5 m   | <a href="http://www.wago.com/756-1203/060-050">www.wago.com/756-1203/060-050</a> |
|    | <b>Item no.: 756-1203/060-100</b><br>ETHERNET cable; 4-pole; M12 plug, axial; M12 plug, axial; Length: 10 m  | <a href="http://www.wago.com/756-1203/060-100">www.wago.com/756-1203/060-100</a> |
|    | <b>Item no.: 756-1203/060-200</b><br>ETHERNET cable; 4-pole; M12 plug, axial; M12 plug, axial; Length: 20 m  | <a href="http://www.wago.com/756-1203/060-200">www.wago.com/756-1203/060-200</a> |
|    | <b>Item no.: 756-1204/060-010</b><br>ETHERNET/PROFINET cable, angled; 1 m; fitted on both ends; D-coded; M12 plug, angled; M12 plug, angled; green | <a href="http://www.wago.com/756-1204/060-010">www.wago.com/756-1204/060-010</a> |
|   | <b>Item no.: 756-1204/060-020</b><br>ETHERNET cable; 4-pole; M12 plug, right angle; M12 plug, right angle; Length: 2 m                             | <a href="http://www.wago.com/756-1204/060-020">www.wago.com/756-1204/060-020</a> |
|  | <b>Item no.: 756-1204/060-030</b><br>ETHERNET cable; 4-pole; M12 plug, right angle; M12 plug, right angle; Length: 3 m                             | <a href="http://www.wago.com/756-1204/060-030">www.wago.com/756-1204/060-030</a> |
|  | <b>Item no.: 756-1204/060-050</b><br>ETHERNET cable; 4-pole; M12 plug, right angle; M12 plug, right angle; Length: 5 m                             | <a href="http://www.wago.com/756-1204/060-050">www.wago.com/756-1204/060-050</a> |
|  | <b>Item no.: 756-1204/060-100</b><br>ETHERNET cable; 4-pole; M12 plug, right angle; M12 plug, right angle; Length: 10 m                            | <a href="http://www.wago.com/756-1204/060-100">www.wago.com/756-1204/060-100</a> |
|  | <b>Item no.: 756-1204/060-200</b><br>ETHERNET cable; 4-pole; M12 plug, right angle; M12 plug, right angle; Length: 20 m                            | <a href="http://www.wago.com/756-1204/060-200">www.wago.com/756-1204/060-200</a> |
|  | <b>Item no.: 756-3501/050-020</b><br>Power cable; M12L socket; straight; 5-pole; Length: 2 m   | <a href="http://www.wago.com/756-3501/050-020">www.wago.com/756-3501/050-020</a> |
|  | <b>Item no.: 756-3501/050-050</b><br>Power cable; M12L socket; straight; 5-pole; Length: 5 m   | <a href="http://www.wago.com/756-3501/050-050">www.wago.com/756-3501/050-050</a> |

Subject to changes. Please also observe the further product documentation!

|  |  |  |
|--|--|--|
|    | <b>Item no.: 756-3501/050-075</b><br>Power cable; M12L socket; straight; 5-pole; Length: 7.5 m | <a href="http://www.wago.com/756-3501/050-075">www.wago.com/756-3501/050-075</a> |
|    | <b>Item no.: 756-3501/050-100</b><br>Power cable; M12L socket; straight; 5-pole; Length: 10 m  | <a href="http://www.wago.com/756-3501/050-100">www.wago.com/756-3501/050-100</a> |
|    | <b>Item no.: 756-3501/050-150</b><br>Power cable; M12L socket; straight; 5-pole; Length: 15 m  | <a href="http://www.wago.com/756-3501/050-150">www.wago.com/756-3501/050-150</a> |
|    | <b>Item no.: 756-3502/050-020</b><br>Power cable; M12L socket; angled; 5-pole; Length: 2 m     | <a href="http://www.wago.com/756-3502/050-020">www.wago.com/756-3502/050-020</a> |
|    | <b>Item no.: 756-3502/050-050</b><br>Power cable; M12L socket; angled; 5-pole; Length: 5 m     | <a href="http://www.wago.com/756-3502/050-050">www.wago.com/756-3502/050-050</a> |
|    | <b>Item no.: 756-3502/050-075</b><br>Power cable; M12L socket; angled; 5-pole; Length: 7.5 m   | <a href="http://www.wago.com/756-3502/050-075">www.wago.com/756-3502/050-075</a> |
|   | <b>Item no.: 756-3502/050-100</b><br>Power cable; M12L socket; angled; 5-pole; Length: 10 m    | <a href="http://www.wago.com/756-3502/050-100">www.wago.com/756-3502/050-100</a> |
|  | <b>Item no.: 756-3502/050-150</b><br>Power cable; M12L socket; angled; 5-pole; Length: 15 m    | <a href="http://www.wago.com/756-3502/050-150">www.wago.com/756-3502/050-150</a> |
|  | <b>Item no.: 756-3503/050-020</b><br>Power cable; M12L plug; straight; 5-pole; Length: 2 m     | <a href="http://www.wago.com/756-3503/050-020">www.wago.com/756-3503/050-020</a> |
|  | <b>Item no.: 756-3503/050-050</b><br>Power cable; M12L plug; straight; 5-pole; Length: 5 m     | <a href="http://www.wago.com/756-3503/050-050">www.wago.com/756-3503/050-050</a> |
|  | <b>Item no.: 756-3503/050-075</b><br>Power cable; M12L plug; straight; 5-pole; Length: 7.5 m   | <a href="http://www.wago.com/756-3503/050-075">www.wago.com/756-3503/050-075</a> |
|  | <b>Item no.: 756-3503/050-100</b><br>Power cable; M12L plug; straight; 5-pole; Length: 10 m    | <a href="http://www.wago.com/756-3503/050-100">www.wago.com/756-3503/050-100</a> |
|  | <b>Item no.: 756-3503/050-150</b><br>Power cable; M12L plug; straight; 5-pole; Length: 15 m    | <a href="http://www.wago.com/756-3503/050-150">www.wago.com/756-3503/050-150</a> |

Subject to changes. Please also observe the further product documentation!

|  |   |  |
|--|---|--|
|    | <b>Item no.: 756-3504/050-020</b><br>Power cable; M12L plug; angled; 5-pole; Length: 2 m                            | <a href="http://www.wago.com/756-3504/050-020">www.wago.com/756-3504/050-020</a> |
|    | <b>Item no.: 756-3504/050-050</b><br>Power cable; M12L plug; angled; 5-pole; Length: 5 m                            | <a href="http://www.wago.com/756-3504/050-050">www.wago.com/756-3504/050-050</a> |
|    | <b>Item no.: 756-3504/050-075</b><br>Power cable; M12L plug; angled; 5-pole; Length: 7.5 m                          | <a href="http://www.wago.com/756-3504/050-075">www.wago.com/756-3504/050-075</a> |
|    | <b>Item no.: 756-3504/050-100</b><br>Power cable; M12L plug; angled; 5-pole; Length: 10 m                           | <a href="http://www.wago.com/756-3504/050-100">www.wago.com/756-3504/050-100</a> |
|    | <b>Item no.: 756-3504/050-150</b><br>Power cable; M12L plug; angled; 5-pole; Length: 15 m                           | <a href="http://www.wago.com/756-3504/050-150">www.wago.com/756-3504/050-150</a> |
|    | <b>Item no.: 756-3505/050-003</b><br>Power cable; M12L socket; straight; M12L plug; straight; 5-pole; Length: 0.3 m | <a href="http://www.wago.com/756-3505/050-003">www.wago.com/756-3505/050-003</a> |
|    | <b>Item no.: 756-3505/050-005</b><br>Power cable; M12L socket; straight; M12L plug; straight; 5-pole; Length: 0.5 m | <a href="http://www.wago.com/756-3505/050-005">www.wago.com/756-3505/050-005</a> |
|  | <b>Item no.: 756-3505/050-010</b><br>Power cable; M12L socket; straight; M12L plug; straight; 5-pole; Length: 1 m   | <a href="http://www.wago.com/756-3505/050-010">www.wago.com/756-3505/050-010</a> |
|  | <b>Item no.: 756-3505/050-020</b><br>Power cable; M12L socket; straight; M12L plug; straight; 5-pole; Length: 2 m   | <a href="http://www.wago.com/756-3505/050-020">www.wago.com/756-3505/050-020</a> |
|  | <b>Item no.: 756-3505/050-050</b><br>Power cable; M12L socket; straight; M12L plug; straight; 5-pole; Length: 5 m   | <a href="http://www.wago.com/756-3505/050-050">www.wago.com/756-3505/050-050</a> |
|  | <b>Item no.: 756-3505/050-075</b><br>Power cable; M12L socket; straight; M12L plug; straight; 5-pole; Length: 7.5 m | <a href="http://www.wago.com/756-3505/050-075">www.wago.com/756-3505/050-075</a> |
|  | <b>Item no.: 756-3505/050-100</b><br>Power cable; M12L socket; straight; M12L plug; straight; 5-pole; Length: 10 m  | <a href="http://www.wago.com/756-3505/050-100">www.wago.com/756-3505/050-100</a> |
|  | <b>Item no.: 756-3505/050-150</b><br>Power cable; M12L socket; straight; M12L plug; straight; 5-pole; Length: 15 m  | <a href="http://www.wago.com/756-3505/050-150">www.wago.com/756-3505/050-150</a> |

Subject to changes. Please also observe the further product documentation!



**Item no.: 756-3506/050-003**  
Power cable; M12L socket; angled; M12L plug; angled; 5-pole; Length: 0.3 m

[www.wago.com/756-3506/050-003](http://www.wago.com/756-3506/050-003)



**Item no.: 756-3506/050-005**  
Power cable; M12L socket; angled; M12L plug; angled; 5-pole; Length: 0.5 m

[www.wago.com/756-3506/050-005](http://www.wago.com/756-3506/050-005)



**Item no.: 756-3506/050-010**  
Power cable; M12L socket; angled; M12L plug; angled; 5-pole; Length: 1 m

[www.wago.com/756-3506/050-010](http://www.wago.com/756-3506/050-010)



**Item no.: 756-3506/050-020**  
Power cable; M12L socket; angled; M12L plug; angled; 5-pole; Length: 2 m

[www.wago.com/756-3506/050-020](http://www.wago.com/756-3506/050-020)



**Item no.: 756-3506/050-050**  
Power cable; M12L socket; angled; M12L plug; angled; 5-pole; Length: 5 m

[www.wago.com/756-3506/050-050](http://www.wago.com/756-3506/050-050)



**Item no.: 756-3506/050-075**  
Power cable; M12L socket; angled; M12L plug; angled; 5-pole; Length: 7.5 m

[www.wago.com/756-3506/050-075](http://www.wago.com/756-3506/050-075)



**Item no.: 756-3506/050-100**  
Power cable; M12L socket; angled; M12L plug; angled; 5-pole; Length: 10 m

[www.wago.com/756-3506/050-100](http://www.wago.com/756-3506/050-100)



**Item no.: 756-3506/050-150**  
Power cable; M12L socket; angled; M12L plug; angled; 5-pole; Length: 15 m

[www.wago.com/756-3506/050-150](http://www.wago.com/756-3506/050-150)

## Downloads Documentation

### Manual

|   |                        |                |          |
|---|------------------------|----------------|----------|
| 8-Kanal-Digitalein-/ausgang; Profinet<br>DC 24 V / 2,0 A; 4xM12-Anschluss; SlimLine | V 2.0.0<br>Sep 8, 2020 | pdf<br>12.3 MB | Download |
|---|------------------------|----------------|----------|

### System Description

|  |  |                 |          |
|--|--|-----------------|----------|
| WAGO I/O System Field; General Product Information |  | pdf<br>708.2 kB | Download |
|--|--|-----------------|----------|

## Device Files

### Device Description File

Subject to changes. Please also observe the further product documentation!

WAGO Corporation  
Germantown, WI 53022  
Phone: 1-800-DIN-RAIL (346-7245) | Fax: (262) 255-6222  
Email: [info.us@wago.com](mailto:info.us@wago.com) | Web: [www.wago.us](http://www.wago.us)

Do you have any questions about our products?  
We are always happy to take your call at {0}.

Data sheet | Item number: 765-1104/100-000 **NEW**

[www.wago.com/765-1104\\_100-0000](http://www.wago.com/765-1104_100-0000)



750-916; GSD-Dateien der Version 2.x für PROFINET/ Serie 750/753, 765, 767 und 852

2.7.1  
Oct 1, 2020

zip  
2.4 MB

Download

---

## Installation Notes

Subject to changes. Please also observe the further product documentation!

---

WAGO Corporation  
Germantown, WI 53022  
Phone: 1-800-DIN-RAIL (346-7245) | Fax: (262) 255-6222  
Email: [info.us@wago.com](mailto:info.us@wago.com) | Web: [www.wago.us](http://www.wago.us)

Do you have any questions about our products?  
We are always happy to take your call at {0}.