

This item has been discontinued and as of 30.09.2018, can no longer be delivered.



Data sheet | Item number: 767-4807/000-800

8-channel digital output; 24 VDC; 0.5 A; Interference-free; 8 x M12; light gray

www.wago.com/767-4807_000-800

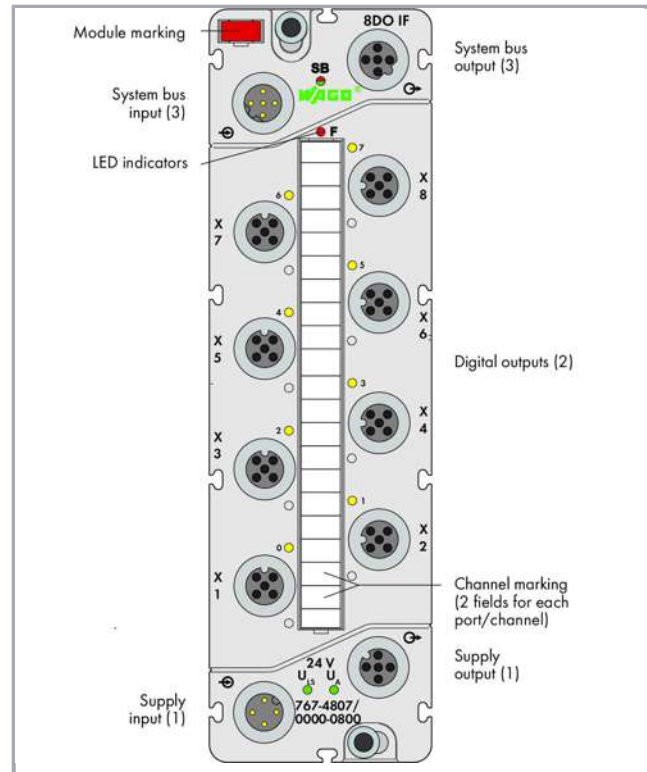

Subject to changes. Please also observe the further product documentation!

WAGO Kontakttechnik GmbH & Co. KG
Hansastr. 27
32423 Minden
Phone: +49571 887-0 | Fax: +49571 887-169
Email: info.de@wago.com | Web: www.wago.com

Do you have any questions about our products?
We are always happy to take your call at +49 (571) 887-44222.



Data sheet | Item number: 767-4807/000-800

www.wago.com/767-4807_000-800

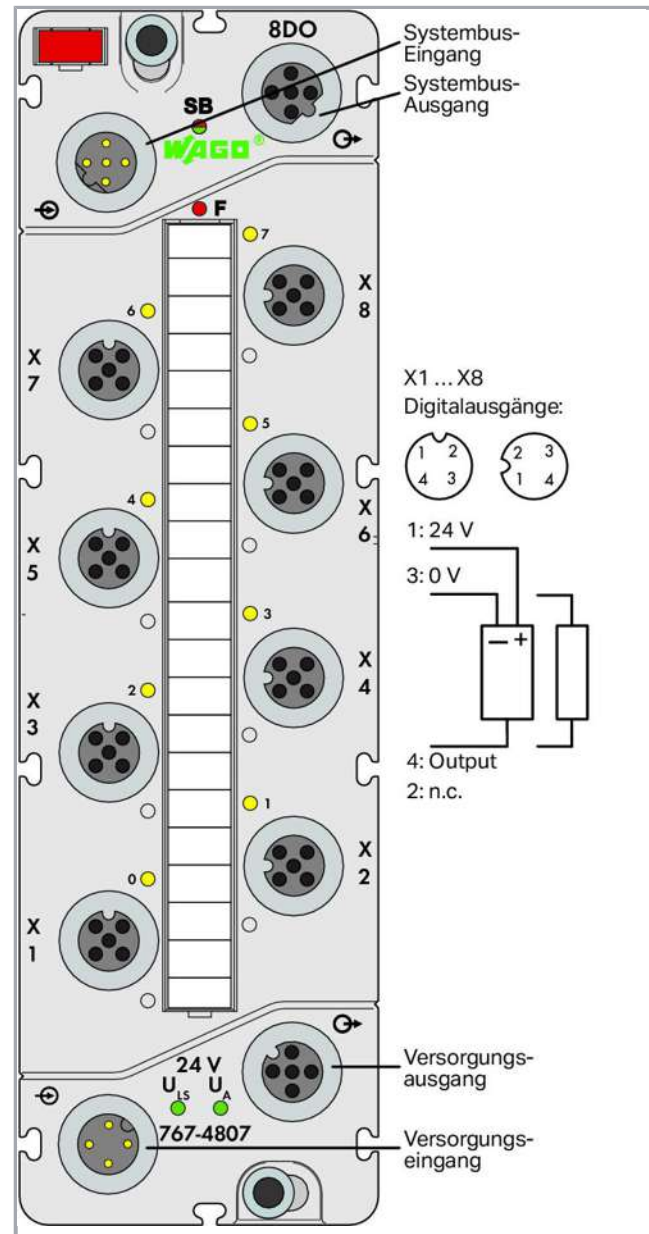
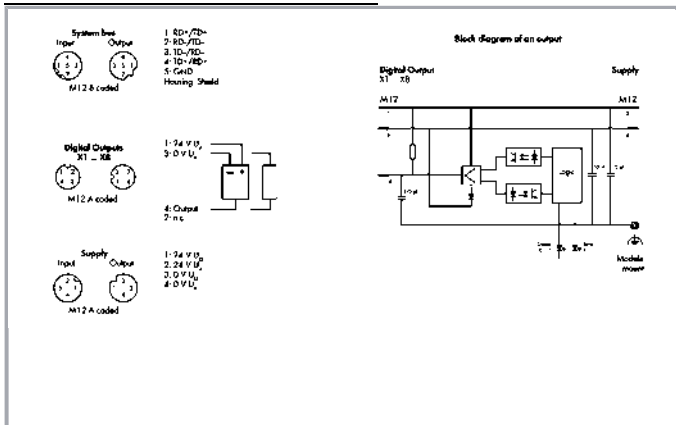

Item description

Short description:

This digital output module controls actuators (e.g., magnetic valves, DC contactors, indicators).

Features:

- Eight digital outputs, 24 VDC / 0.5 A
- Diagnostic-capable (per channel)
- Parameterizable (inversion, substitute value strategy, substitute value, manual mode, online simulation and diagnostics)

Subject to changes. Please also observe the further product documentation!

WAGO Kontakttechnik GmbH & Co. KG
 Hansastr. 27
 32423 Minden
 Phone: +49571 887-0 | Fax: +49571 887-169
 Email: info.de@wago.com | Web: www.wago.com

Do you have any questions about our products?
 We are always happy to take your call at +49 (571) 887-44222.



Data sheet | Item number: 767-4807/000-800

www.wago.com/767-4807_000-800

Includes:

- 1 x WMB marker, red
- 1 x marking strip
- 2 x M12 protective cap

Data

Technical Data

| | |
|--------------------------------------|--|
| Number of digital outputs | 8 |
| Total number of channels (module) | 8 |
| Type of signal | Voltage |
| Type of signal voltage | DC 24 V |
| Actuator connection | 8 x (2-wire, 3-wire) |
| Output characteristic | high-side switching |
| Output current per channel | 0.5 A |
| Output current (module) | 4 A |
| Output current | short-circuit/overload-protected |
| Leakage current in OFF state | 150 µA |
| Switching frequency max. | 500 Hz; Inductive load |
| Switching frequency max. (2) | 20 Hz; Resistive load |
| Switching frequency max. (3) | 500 Hz; Lamp load |
| Type of load | Resistive, inductive, lamp load |
| Load type of the switching frequency | Inductive load |
| Process data width | 1-byte data + status |
| Parametrierbare Funktionen | I/O diagnostics (per module): Undervoltage ($U_{LS} + U_A$) I/O diagnostics (per channel): Short circuit/overload (actuators); Wire break (actuators); Overtemperature Online simulation (per module): Diagnostics Online simulation (per channel): Lock/unlock; simulation value: 0/1; Diagnostics Inversion (per channel): On/off Substitute value (per channel): 0/1 Substitute value strategy (per channel): Switch substitute value/hold last value Manual mode (per channel): On/off Manual mode value (by channel): 0/1 |
| Protection | Reverse voltage protection for $U_{LS} + U_o$ |
| Output resistance | 0.4 Ω |
| System and sensor supply voltage | DC 24 V(-25 ... +30 %); Logic and sensors (U_{LS}) |

Subject to changes. Please also observe the further product documentation!

This item has been discontinued and as of 30.09.2018, can no longer be delivered.



Data sheet | Item number: 767-4807/000-800

www.wago.com/767-4807_000-800

| | |
|--|--|
| Current consumption: System and sensor | 45 mA |
| Stromaufnahme System und Sensor Hinweis | logic component only |
| Field supply voltage | DC 24 V (-25 ... +30 %); Actuators (U_A) |
| Current consumption, field supply (module with no external load) | 25 mA |
| Isolation | 500 V supply/system bus |
| Interference-free for safety function applications | Yes |
| Indicators | LED (F) red: Error status; LED (SB) green/red/orange: System bus status; LED (U_{LS} , U_A) green: Power supply status; LED (0 ... 7) yellow/red: Status/diagnostics DO 1 ... DO 8; Non-retentive displays |
| Current carrying capacity of the supply connections | 8 A |

Connection data

| | |
|---|--|
| Connection technology: In-/Outputs | 8 x M12 socket; A-coded; 4-pole |
| Connection technology: field supply | 1 x M12 plug; 4-pole; A-coded; 1 x M12 socket, 4-pole, A-coded |
| Connection technology: system supply | 1 x M12 socket; 4-pole; A-coded; 1 x M12 plug; 4-pole; A-coded |
| Connection technology: System bus | 1 x M12 socket, 5-pole, B-coded, shielded; 1 x M12 plug, 5-pole, B-coded, shielded |
| Anschlussanforderung zulässige Leitungslänge | 30 m |
| Connection requirement (permissible cable type) | Digital outputs: unshielded |

Geometrical Data

| | |
|--------|----------------------|
| Width | 50 mm / 1.969 inch |
| Height | 35,7 mm / 1.406 inch |
| Depth | 170 mm / 6.693 inch |

Material Data

| | |
|--------------------|---|
| Color | light gray |
| Housing material | Polyamide (PA), Makrolon (address switch cover), flammability per UL94-V0, halogen/silicon-free |
| Weight | 387 g |
| Conformity marking | CE |
| Potting | Polyurethane (PUR), halogen/silicon-free |

Environmental Requirements

| | |
|---|---------------|
| Surrounding air (operating) temperature | -25 ... 60 °C |
| Surrounding air (storage) temperature | -40 ... 85 °C |
| Protection class | IP67 |

Subject to changes. Please also observe the further product documentation!

WAGO Kontakttechnik GmbH & Co. KG
Hansastr. 27
32423 Minden
Phone: +49571 887-0 | Fax: +49571 887-169
Email: info.de@wago.com | Web: www.wago.com

Do you have any questions about our products?
We are always happy to take your call at +49 (571) 887-44222.

This item has been discontinued and as of 30.09.2018, can no longer be delivered.



Data sheet | Item number: 767-4807/000-800

www.wago.com/767-4807_000-800



| | |
|--|--|
| Protection class | III |
| Operating altitude | -1000 ... 2000 m; air pressure: 1080 ... 795 hPa |
| Relative air humidity (no condensation) | 95 % |
| Vibration resistance | 5g per IEC 60068-2-6 |
| Shock resistance | Short-term: 50g/11 ms/half-sine per IEC 60068-2-27; Long-term: 30g/6 ms/half-sine per IEC 60068-2-29 |
| EMC immunity to interference | per EN 61000-6-2 |
| EMC emission of interference | per EN 61000-6-4 |
| Permissible H ₂ S contaminant concentration at a relative humidity 75 % | 0.1 ppm |
| Permissible SO ₂ contaminant concentration at a relative humidity 75 % | 0.5 ppm |

Commercial data

| | |
|--------------------|-----------------|
| Product Group | 15 (Remote I/O) |
| Packaging type | BOX |
| Country of origin | DE |
| GTIN | 4050821374190 |
| Customs Tariff No. | 85389091890 |

Approvals / Certificates

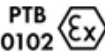
Ex-Approvals

| Logo | Approval | Additional Approval Text | Certificate name |
|--|--------------------------|--------------------------|---------------------|
|  | ATEX DEKRA EXAM GmbH | EN 60079-0 | BVS_15_ATEX_E_098_X |
|  | IECEX DEKRA EXAM GmbH | IEC 60079-0 | IECEX_BVS_15.0083_X |

UL-Approvals

| Logo | Approval | Additional Approval Text | Certificate name |
|--|--|--------------------------|------------------|
|  | UL UL International Germany GmbH (ORDINARY LOCATIONS) | UL 508 | E175199 Sec.5 |

Subject to changes. Please also observe the further product documentation!

WAGO Kontakttechnik GmbH & Co. KG
Hansastr. 27
32423 Minden
Phone: +49571 887-0 | Fax: +49571 887-169
Email: info.de@wago.com | Web: www.wago.com

Do you have any questions about our products?
We are always happy to take your call at +49 (571) 887-44222.

This item has been discontinued and as of 30.09.2018, can no longer be delivered.









Data sheet | Item number: 767-4807/000-800

www.wago.com/767-4807_000-800

Counterpart

Compatible products



General accessories

| | | |
|--|---|--|
|  | Item no.: 756-8102 M12 protective cap; for unused sockets; - | www.wago.com/756-8102 |
|  | Item no.: 756-8103 M12 protective cap; for unused plugs; - | www.wago.com/756-8103 |
|  | Item no.: 756-8302 Securing clip; M12 | www.wago.com/756-8302 |
|  | Item no.: 767-111 Spacer module; - | www.wago.com/767-111 |
|  | Item no.: 767-125 Carrier rail adapter; for I/O-Modul 8 x M12 | www.wago.com/767-125 |
|  | Item no.: 767-126 Profile adapter; for I/O-Modul 8 x M12 | www.wago.com/767-126 |

tools

| | | |
|--|--|--|
|  | Item no.: 206-701 Torque wrench M8 and M12; Assembly kit | www.wago.com/206-701 |
|--|--|--|

Marking accessories

| | | |
|--|--|--|
|  | Item no.: 210-110 Fiber-tip pen | www.wago.com/210-110 |
|  | Item no.: 757-901/000-050 Marking strips; on reel; not stretchable; plain; snap-on type; white | www.wago.com/757-901/000-050 |
|  | Item no.: 767-104 Marking strips | www.wago.com/767-104 |

wiring and connectors

| | | |
|--|---|--|
|  | Item no.: 756-1300/000-1000 System bus cable; 5-pole; Length: 100 m; yellow | www.wago.com/756-1300/000-1000 |
|  | Item no.: 756-1300/000-250 System bus cable; 5-pole; Length: 25 m; yellow | www.wago.com/756-1300/000-250 |

Subject to changes. Please also observe the further product documentation!

WAGO Kontakttechnik GmbH & Co. KG
Hansastr. 27
32423 Minden
Phone: +49571 887-0 | Fax: +49571 887-169
Email: info.de@wago.com | Web: www.wago.com













Do you have any questions about our products?
We are always happy to take your call at +49 (571) 887-44222.

This item has been discontinued and as of 30.09.2018, can no longer be delivered.



Data sheet | Item number: 767-4807/000-800

www.wago.com/767-4807_000-800

| | | |
|--|---|--|
|  | Item no.: 756-1300/000-500 System bus cable; 5-pole; Length: 50 m; yellow | www.wago.com/756-1300/000-500 |
|  | Item no.: 756-1301/060-020 System bus cable; 5-pole; Length: 2 m | www.wago.com/756-1301/060-020 |
|  | Item no.: 756-1301/060-050 System bus cable; 5-pole; Length: 5 m | www.wago.com/756-1301/060-050 |
|  | Item no.: 756-1301/060-100 System bus cable; 5-pole; Length: 10 m | www.wago.com/756-1301/060-100 |
|  | Item no.: 756-1301/060-200 System bus cable; 5-pole; Length: 20 m | www.wago.com/756-1301/060-200 |
|  | Item no.: 756-1302/060-020 System bus cable; 5-pole; Length: 2 m | www.wago.com/756-1302/060-020 |
|  | Item no.: 756-1302/060-050 System bus cable; 5-pole; Length: 5 m | www.wago.com/756-1302/060-050 |
|  | Item no.: 756-1302/060-100 System bus cable; 5-pole; Length: 10 m | www.wago.com/756-1302/060-100 |
|  | Item no.: 756-1302/060-200 System bus cable; 5-pole; Length: 20 m | www.wago.com/756-1302/060-200 |
|  | Item no.: 756-1303/060-020 System bus cable; 5-pole; Length: 2 m | www.wago.com/756-1303/060-020 |
|  | Item no.: 756-1303/060-050 System bus cable; 5-pole; Length: 5 m | www.wago.com/756-1303/060-050 |
|  | Item no.: 756-1303/060-100 System bus cable; 5-pole; Length: 10 m | www.wago.com/756-1303/060-100 |
|  | Item no.: 756-1303/060-200 System bus cable; 5-pole; Length: 20 m | www.wago.com/756-1303/060-200 |

Subject to changes. Please also observe the further product documentation!

WAGO Kontakttechnik GmbH & Co. KG
Hansastr. 27
32423 Minden
Phone: +49571 887-0 | Fax: +49571 887-169
Email: info.de@wago.com | Web: www.wago.com













Do you have any questions about our products?
We are always happy to take your call at +49 (571) 887-44222.

This item has been discontinued and as of 30.09.2018, can no longer be delivered.



Data sheet | Item number: 767-4807/000-800

www.wago.com/767-4807_000-800

| | | |
|--|--|--|
|  | Item no.: 756-1304/060-020 System bus cable; 5-pole; Length: 2 m | www.wago.com/756-1304/060-020 |
|  | Item no.: 756-1304/060-050 System bus cable; 5-pole; Length: 5 m | www.wago.com/756-1304/060-050 |
|  | Item no.: 756-1304/060-100 System bus cable; 5-pole; Length: 10 m | www.wago.com/756-1304/060-100 |
|  | Item no.: 756-1304/060-200 System bus cable; 5-pole; Length: 20 m | www.wago.com/756-1304/060-200 |
|  | Item no.: 756-1305/060-002 System bus cable; 5-pole; Length 0.2 m | www.wago.com/756-1305/060-002 |
|  | Item no.: 756-1305/060-003 System bus cable; 5-pole; Length: 0.3 m | www.wago.com/756-1305/060-003 |
|  | Item no.: 756-1305/060-005 System bus cable; 5-pole; Length: 0.5 m | www.wago.com/756-1305/060-005 |
|  | Item no.: 756-1305/060-010 System bus cable; 5-pole; Length: 1 m | www.wago.com/756-1305/060-010 |
|  | Item no.: 756-1305/060-020 System bus cable; 5-pole; Length: 2 m | www.wago.com/756-1305/060-020 |
|  | Item no.: 756-1305/060-030 System bus cable; 5-pole; Length: 3 m | www.wago.com/756-1305/060-030 |
|  | Item no.: 756-1305/060-050 System bus cable; 5-pole; Length: 5 m | www.wago.com/756-1305/060-050 |
|  | Item no.: 756-1305/060-070 System bus cable; 5-pole; Length: 7 m | www.wago.com/756-1305/060-070 |
|  | Item no.: 756-1305/060-100 System bus cable; 5-pole; Length: 10 m | www.wago.com/756-1305/060-100 |

Subject to changes. Please also observe the further product documentation!

WAGO Kontakttechnik GmbH & Co. KG
Hansastr. 27
32423 Minden
Phone: +49571 887-0 | Fax: +49571 887-169
Email: info.de@wago.com | Web: www.wago.com













Do you have any questions about our products?
We are always happy to take your call at +49 (571) 887-44222.

This item has been discontinued and as of 30.09.2018, can no longer be delivered.



Data sheet | Item number: 767-4807/000-800

www.wago.com/767-4807_000-800

| | | |
|--|--|--|
|  | Item no.: 756-1305/060-200 System bus cable; 5-pole; Length: 20 m | www.wago.com/756-1305/060-200 |
|  | Item no.: 756-1305/060-500 System bus cable; 5-pole; Length: 50 m | www.wago.com/756-1305/060-500 |
|  | Item no.: 756-1306/060-002 System bus cable; 5-pole; Length 0.2 m | www.wago.com/756-1306/060-002 |
|  | Item no.: 756-1306/060-003 System bus cable; 5-pole; Length: 0.3 m | www.wago.com/756-1306/060-003 |
|  | Item no.: 756-1306/060-005 System bus cable; 5-pole; Length: 0.5 m | www.wago.com/756-1306/060-005 |
|  | Item no.: 756-1306/060-010 System bus cable; 5-pole; Length: 1 m | www.wago.com/756-1306/060-010 |
|  | Item no.: 756-1306/060-020 System bus cable; 5-pole; Length: 2 m | www.wago.com/756-1306/060-020 |
|  | Item no.: 756-1306/060-030 System bus cable; 5-pole; Length: 3 m | www.wago.com/756-1306/060-030 |
|  | Item no.: 756-1306/060-050 System bus cable; 5-pole; Length: 5 m | www.wago.com/756-1306/060-050 |
|  | Item no.: 756-1306/060-070 System bus cable; 5-pole; Length: 7 m | www.wago.com/756-1306/060-070 |
|  | Item no.: 756-1306/060-100 System bus cable; 5-pole; Length: 10 m | www.wago.com/756-1306/060-100 |
|  | Item no.: 756-1306/060-200 System bus cable; 5-pole; Length: 20 m | www.wago.com/756-1306/060-200 |
|  | Item no.: 756-1306/060-500 System bus cable; 5-pole; Length: 50 m | www.wago.com/756-1306/060-500 |

Subject to changes. Please also observe the further product documentation!

WAGO Kontakttechnik GmbH & Co. KG
Hansastr. 27
32423 Minden
Phone: +49571 887-0 | Fax: +49571 887-169
Email: info.de@wago.com | Web: www.wago.com













Do you have any questions about our products?
We are always happy to take your call at +49 (571) 887-44222.

This item has been discontinued and as of 30.09.2018, can no longer be delivered.



Data sheet | Item number: 767-4807/000-800

www.wago.com/767-4807_000-800

| | | |
|--|--|--|
|  | Item no.: 756-1500/000-1000 System bus cable for drag chain; 5-pole; Length: 100 m | www.wago.com/756-1500/000-1000 |
|  | Item no.: 756-1500/000-250 System bus cable for drag chain; 5-pole; Length: 25 m | www.wago.com/756-1500/000-250 |
|  | Item no.: 756-1500/000-500 System bus cable for drag chain; 5-pole; Length: 50 m | www.wago.com/756-1500/000-500 |
|  | Item no.: 756-1501/060-020 System bus cable for drag chain; 5-pole; Length: 2 m | www.wago.com/756-1501/060-020 |
|  | Item no.: 756-1501/060-050 System bus cable for drag chain; 5-pole; Length: 5 m | www.wago.com/756-1501/060-050 |
|  | Item no.: 756-1501/060-100 System bus cable for drag chain; 5-pole; Length: 10 m | www.wago.com/756-1501/060-100 |
|  | Item no.: 756-1501/060-200 System bus cable for drag chain; 5-pole; Length: 20 m | www.wago.com/756-1501/060-200 |
|  | Item no.: 756-1502/060-020 System bus cable for drag chain; 5-pole; Length: 2 m | www.wago.com/756-1502/060-020 |
|  | Item no.: 756-1502/060-050 System bus cable for drag chain; 5-pole; Length: 5 m | www.wago.com/756-1502/060-050 |
|  | Item no.: 756-1502/060-100 System bus cable for drag chain; 5-pole; Length: 10 m | www.wago.com/756-1502/060-100 |
|  | Item no.: 756-1502/060-200 System bus cable for drag chain; 5-pole; Length: 20 m | www.wago.com/756-1502/060-200 |
|  | Item no.: 756-1503/060-020 System bus cable for drag chain; 5-pole; Length: 2 m | www.wago.com/756-1503/060-020 |
|  | Item no.: 756-1503/060-050 System bus cable for drag chain; 5-pole; Length: 5 m | www.wago.com/756-1503/060-050 |

Subject to changes. Please also observe the further product documentation!

WAGO Kontakttechnik GmbH & Co. KG
Hansastr. 27
32423 Minden
Phone: +49571 887-0 | Fax: +49571 887-169
Email: info.de@wago.com | Web: www.wago.com













Do you have any questions about our products?
We are always happy to take your call at +49 (571) 887-44222.

This item has been discontinued and as of 30.09.2018, can no longer be delivered.



Data sheet | Item number: 767-4807/000-800

www.wago.com/767-4807_000-800

| | | |
|--|---|--|
|  | Item no.: 756-1503/060-100 System bus cable for drag chain; 5-pole; Length: 10 m | www.wago.com/756-1503/060-100 |
|  | Item no.: 756-1503/060-200 System bus cable for drag chain; 5-pole; Length: 20 m | www.wago.com/756-1503/060-200 |
|  | Item no.: 756-1504/060-020 System bus cable for drag chain; 5-pole; Length: 2 m | www.wago.com/756-1504/060-020 |
|  | Item no.: 756-1504/060-050 System bus cable for drag chain; 5-pole; Length: 5 m | www.wago.com/756-1504/060-050 |
|  | Item no.: 756-1504/060-100 System bus cable for drag chain; 5-pole; Length: 10 m | www.wago.com/756-1504/060-100 |
|  | Item no.: 756-1504/060-200 System bus cable for drag chain; 5-pole; Length: 20 m | www.wago.com/756-1504/060-200 |
|  | Item no.: 756-1505/060-002 System bus cable for drag chain; 5-pole; Length 0.2 m | www.wago.com/756-1505/060-002 |
|  | Item no.: 756-1505/060-003 System bus cable for drag chain; 5-pole; Length: 0.3 m | www.wago.com/756-1505/060-003 |
|  | Item no.: 756-1505/060-005 System bus cable for drag chain; 5-pole; Length: 0.5 m | www.wago.com/756-1505/060-005 |
|  | Item no.: 756-1505/060-010 System bus cable for drag chain; 5-pole; Length: 1 m | www.wago.com/756-1505/060-010 |
|  | Item no.: 756-1505/060-020 System bus cable for drag chain; 5-pole; Length: 2 m | www.wago.com/756-1505/060-020 |
|  | Item no.: 756-1505/060-050 System bus cable for drag chain; 5-pole; Length: 5 m | www.wago.com/756-1505/060-050 |
|  | Item no.: 756-1505/060-100 System bus cable for drag chain; 5-pole; Length: 10 m | www.wago.com/756-1505/060-100 |

Subject to changes. Please also observe the further product documentation!

WAGO Kontakttechnik GmbH & Co. KG
Hansastr. 27
32423 Minden
Phone: +49571 887-0 | Fax: +49571 887-169
Email: info.de@wago.com | Web: www.wago.com













Do you have any questions about our products?
We are always happy to take your call at +49 (571) 887-44222.

This item has been discontinued and as of 30.09.2018, can no longer be delivered.



Data sheet | Item number: 767-4807/000-800

www.wago.com/767-4807_000-800

| | | |
|--|---|--|
|  | Item no.: 756-1505/060-200 System bus cable for drag chain; 5-pole; Length: 20 m | www.wago.com/756-1505/060-200 |
|  | Item no.: 756-1505/060-500 System bus cable for drag chain; 5-pole; Length: 50 m | www.wago.com/756-1505/060-500 |
|  | Item no.: 756-1506/060-002 System bus cable for drag chain; 5-pole; Length 0.2 m | www.wago.com/756-1506/060-002 |
|  | Item no.: 756-1506/060-003 System bus cable for drag chain; 5-pole; Length: 0.3 m | www.wago.com/756-1506/060-003 |
|  | Item no.: 756-1506/060-005 System bus cable for drag chain; 5-pole; Length: 0.5 m | www.wago.com/756-1506/060-005 |
|  | Item no.: 756-1506/060-010 System bus cable for drag chain; 5-pole; Length: 1 m | www.wago.com/756-1506/060-010 |
|  | Item no.: 756-1506/060-020 System bus cable for drag chain; 5-pole; Length: 2 m | www.wago.com/756-1506/060-020 |
|  | Item no.: 756-1506/060-050 System bus cable for drag chain; 5-pole; Length: 5 m | www.wago.com/756-1506/060-050 |
|  | Item no.: 756-1506/060-100 System bus cable for drag chain; 5-pole; Length: 10 m | www.wago.com/756-1506/060-100 |
|  | Item no.: 756-1506/060-200 System bus cable for drag chain; 5-pole; Length: 20 m | www.wago.com/756-1506/060-200 |
|  | Item no.: 756-1506/060-500 System bus cable for drag chain; 5-pole; Length: 50 m | www.wago.com/756-1506/060-500 |
|  | Item no.: 756-3100/000-1000 Power cable; 4-pole; Length: 100 m | www.wago.com/756-3100/000-1000 |
|  | Item no.: 756-3100/000-250 Power cable; 4-pole; Length: 25 m | www.wago.com/756-3100/000-250 |

Subject to changes. Please also observe the further product documentation!

WAGO Kontakttechnik GmbH & Co. KG
Hansastr. 27
32423 Minden
Phone: +49571 887-0 | Fax: +49571 887-169
Email: info.de@wago.com | Web: www.wago.com













Do you have any questions about our products?
We are always happy to take your call at +49 (571) 887-44222.

This item has been discontinued and as of 30.09.2018, can no longer be delivered.



Data sheet | Item number: 767-4807/000-800

www.wago.com/767-4807_000-800

| | | |
|--|--|--|
|  | Item no.: 756-3100/000-500 Power cable; 4-pole; Length: 50 m | www.wago.com/756-3100/000-500 |
|  | Item no.: 756-3101/040-020 Power cable; 4-pole; Length: 2 m | www.wago.com/756-3101/040-020 |
|  | Item no.: 756-3101/040-050 Power cable; 4-pole; Length: 5 m | www.wago.com/756-3101/040-050 |
|  | Item no.: 756-3101/040-100 Power cable; 4-pole; Length: 10 m | www.wago.com/756-3101/040-100 |
|  | Item no.: 756-3101/040-200 Power cable; 4-pole; Length: 20 m | www.wago.com/756-3101/040-200 |
|  | Item no.: 756-3102/040-020 Power cable; 4-pole; Length: 2 m | www.wago.com/756-3102/040-020 |
|  | Item no.: 756-3102/040-050 Power cable; 4-pole; Length: 5 m | www.wago.com/756-3102/040-050 |
|  | Item no.: 756-3102/040-100 Power cable; 4-pole; Length: 10 m | www.wago.com/756-3102/040-100 |
|  | Item no.: 756-3102/040-200 Power cable; 4-pole; Length: 20 m | www.wago.com/756-3102/040-200 |
|  | Item no.: 756-3103/040-020 Power cable; 4-pole; Length: 2 m | www.wago.com/756-3103/040-020 |
|  | Item no.: 756-3103/040-050 Power supply cable, straight; 5 m; fitted on one end; A-coded; M12 plug, straight; one free cable end; gray | www.wago.com/756-3103/040-050 |
|  | Item no.: 756-3103/040-100 Power cable; 4-pole; Length: 10 m | www.wago.com/756-3103/040-100 |
|  | Item no.: 756-3103/040-200 Power cable; 4-pole; Length: 20 m | www.wago.com/756-3103/040-200 |

Subject to changes. Please also observe the further product documentation!

WAGO Kontakttechnik GmbH & Co. KG
Hansastr. 27
32423 Minden
Phone: +49571 887-0 | Fax: +49571 887-169
Email: info.de@wago.com | Web: www.wago.com













Do you have any questions about our products?
We are always happy to take your call at +49 (571) 887-44222.

This item has been discontinued and as of 30.09.2018, can no longer be delivered.



Data sheet | Item number: 767-4807/000-800

www.wago.com/767-4807_000-800

| | | |
|--|---|--|
|  | Item no.: 756-3104/040-020 Power cable; 4-pole; Length: 2 m | www.wago.com/756-3104/040-020 |
|  | Item no.: 756-3104/040-050 Power cable; 4-pole; Length: 5 m | www.wago.com/756-3104/040-050 |
|  | Item no.: 756-3104/040-100 Power cable; 4-pole; Length: 10 m | www.wago.com/756-3104/040-100 |
|  | Item no.: 756-3104/040-200 Power cable; 4-pole; Length: 20 m | www.wago.com/756-3104/040-200 |
|  | Item no.: 756-3105/040-002 Power cable; 4-pole; Length 0.2 m | www.wago.com/756-3105/040-002 |
|  | Item no.: 756-3105/040-003 Power cable; 4-pole; Length: 0.3 m | www.wago.com/756-3105/040-003 |
|  | Item no.: 756-3105/040-005 Power cable; 4-pole; Length: 0.5 m | www.wago.com/756-3105/040-005 |
|  | Item no.: 756-3105/040-010 Power cable; 4-pole; Length: 1 m | www.wago.com/756-3105/040-010 |
|  | Item no.: 756-3105/040-020 Power cable; 4-pole; Length: 2 m | www.wago.com/756-3105/040-020 |
|  | Item no.: 756-3105/040-030 Power cable; 4-pole; Length: 3 m | www.wago.com/756-3105/040-030 |
|  | Item no.: 756-3105/040-050 Power cable; 4-pole; Length: 5 m | www.wago.com/756-3105/040-050 |
|  | Item no.: 756-3105/040-070 Power cable; 4-pole; Length: 7 m | www.wago.com/756-3105/040-070 |
|  | Item no.: 756-3105/040-100 Power cable; 4-pole; Length: 10 m | www.wago.com/756-3105/040-100 |

Subject to changes. Please also observe the further product documentation!

WAGO Kontakttechnik GmbH & Co. KG
Hansastr. 27
32423 Minden
Phone: +49571 887-0 | Fax: +49571 887-169
Email: info.de@wago.com | Web: www.wago.com

Do you have any questions about our products?
We are always happy to take your call at +49 (571) 887-44222.

This item has been discontinued and as of 30.09.2018, can no longer be delivered.



Data sheet | Item number: 767-4807/000-800

www.wago.com/767-4807_000-800



Item no.: 756-3105/040-200
Power cable; 4-pole; Length: 20 m

www.wago.com/756-3105/040-200



Item no.: 756-3106/040-002
Power cable; 4-pole; Length 0.2 m

www.wago.com/756-3106/040-002



Item no.: 756-3106/040-003
Power cable; 4-pole; Length: 0.3 m

www.wago.com/756-3106/040-003



Item no.: 756-3106/040-005
Power cable; 4-pole; Length: 0.5 m

www.wago.com/756-3106/040-005



Item no.: 756-3106/040-010
Power cable; 4-pole; Length: 1 m

www.wago.com/756-3106/040-010



Item no.: 756-3106/040-020
Power cable; 4-pole; Length: 2 m

www.wago.com/756-3106/040-020



Item no.: 756-3106/040-030
Power cable; 4-pole; Length: 3 m

www.wago.com/756-3106/040-030



Item no.: 756-3106/040-050
Power cable; 4-pole; Length: 5 m

www.wago.com/756-3106/040-050



Item no.: 756-3106/040-070
Power cable; 4-pole; Length: 7 m

www.wago.com/756-3106/040-070



Item no.: 756-3106/040-100
Power cable; 4-pole; Length: 10 m

www.wago.com/756-3106/040-100



Item no.: 756-3106/040-200
Power cable; 4-pole; Length: 20 m

www.wago.com/756-3106/040-200



Item no.: 756-5311/040-015
Sensor/Actuator cable; 4-pole; Length: 1.5 m

www.wago.com/756-5311/040-015



Item no.: 756-5311/040-050
Sensor/Actuator cable; 4-pole; Length: 5 m

www.wago.com/756-5311/040-050

Subject to changes. Please also observe the further product documentation!

WAGO Kontakttechnik GmbH & Co. KG
Hansastr. 27
32423 Minden
Phone: +49571 887-0 | Fax: +49571 887-169
Email: info.de@wago.com | Web: www.wago.com

Do you have any questions about our products?
We are always happy to take your call at +49 (571) 887-44222.

This item has been discontinued and as of 30.09.2018, can no longer be delivered.



Data sheet | Item number: 767-4807/000-800

www.wago.com/767-4807_000-800



Item no.: 756-5311/040-100
Sensor/Actuator cable; 4-pole; Length: 10 m

www.wago.com/756-5311/040-100



Item no.: 756-9203/040-000
Accessories; 4-pole

www.wago.com/756-9203/040-000



Item no.: 756-9206/040-000
Accessories; 4-pole

www.wago.com/756-9206/040-000



Item no.: 756-9213/040-000
Accessories; 4-pole

www.wago.com/756-9213/040-000



Item no.: 756-9216/040-000
Accessories; 4-pole

www.wago.com/756-9216/040-000



Item no.: 756-9404/060-000
Accessories; 5-pole; M12 socket, right angle

www.wago.com/756-9404/060-000



Item no.: 756-9411/060-000
Accessories; 5-pole; M12 plug, axial

www.wago.com/756-9411/060-000



Item no.: 756-9412/060-000
Accessories; 5-pole; M12 socket, straight

www.wago.com/756-9412/060-000



Item no.: 756-9413/060-000
Accessories; 5-pole; M12 plug, right angle

www.wago.com/756-9413/060-000



Item no.: 756-9414/060-000
Accessories; 5-pole; M12 socket, right angle

www.wago.com/756-9414/060-000

Downloads

Documentation

Manual

| | | | |
|---|---------|---------------|----------|
| Digital output module 24VDC / 0.5A; IF; 8 outputs (8 x M12), interference-free | V 1.1.0 | pdf 5.1 MB | Download |
| System Description | V 1.0.0 | pdf 2.1 MB | Download |

Subject to changes. Please also observe the further product documentation!

WAGO Kontakttechnik GmbH & Co. KG
Hansastr. 27
32423 Minden
Phone: +49571 887-0 | Fax: +49571 887-169
Email: info.de@wago.com | Web: www.wago.com

Do you have any questions about our products?
We are always happy to take your call at +49 (571) 887-44222.

This item has been discontinued and as of 30.09.2018, can no longer be delivered.



Data sheet | Item number: 767-4807/000-800

www.wago.com/767-4807_000-800

Instruction Leaflet

Primär getaktete Stromversorgungen EPSITRON-CLASSIC-Power
DC 12 V, 2 A

pdf
198.0 kB

Download

Additional Information

Disposal; Electrical and electronic equipment, Packaging

V 1.0.0

pdf
265.8 kB

Download

System Description

I/O-SYSTEM – SPEEDWAY, General Product Information

pdf
1.1 MB

Download

CAD/CAE-Data

CAE data

EPLAN Data Portal 767-4807/000-800

URL

Download

WSCAD Universe 767-4807/000-800

URL

Download

Device Files

Device Driver

WAGO TCP Service Interface DTM

1.1.4.8
Jun 21, 2013

exe
25.0 MB

Download

WAGO USB Service Kabel Treiber / Serie 767

1.3.3.48
Mar 30, 2012

zip
3.8 MB

Download

WAGO SPEEDWAY DTM / Serie 767

3.4.0.2
Sep 11, 2013

exe
22.8 MB

Download

WAGO Service-Interface DTM / Serie 767 und 857
(zur Kommunikation mit der Serie 857 + 767)

3.2.2.26
Jun 21, 2013

exe
1.5 MB

Download

Installation Notes

Subject to changes. Please also observe the further product documentation!

WAGO Kontakttechnik GmbH & Co. KG

Hansastr. 27

32423 Minden

Phone: +49571 887-0 | Fax: +49571 887-169

Email: info.de@wago.com | Web: www.wago.com

Do you have any questions about our products?

We are always happy to take your call at +49 (571) 887-44222.

This item has been discontinued and as of 30.09.2018, can no longer be delivered.



Data sheet | Item number: 767-4807/000-800

www.wago.com/767-4807_000-800

Product family

767 Series – I/O System

Messen, Steuern, Regeln und Überwachen bei zweistelligen Minusgraden, dauerhaften Vibrationen und harten Stößen, umgeben von Schmutz, Staub und Wasser: Das IP67-I/O-System SPEEDWAY 767 ist mit Feldbuskopplern und I/O-Modulen optimal auf die robuste, schaltschranklose Automation abgestimmt.

[Show all products from the family](#)

Subject to changes. Please also observe the further product documentation!

WAGO Kontakttechnik GmbH & Co. KG

Hansastr. 27

32423 Minden

Phone: +49571 887-0 | Fax: +49571 887-169

Email: info.de@wago.com | Web: www.wago.com

Do you have any questions about our products?

We are always happy to take your call at +49 (571) 887-44222.