

Data sheet | Item number: 769-218/281-411

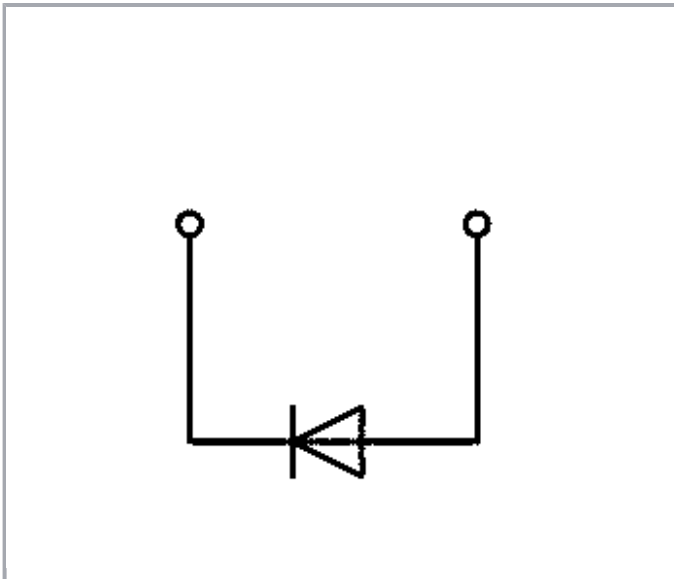

1-conductor/1-pin component carrier terminal block; with 2 jumper positions; with diode 1N4007; anode, right side; for DIN-rail 35 x 15 and 35 x 7.5; 4 mm²; CAGE CLAMP®; 4,00 mm²; gray

www.wago.com/769-218_281-411

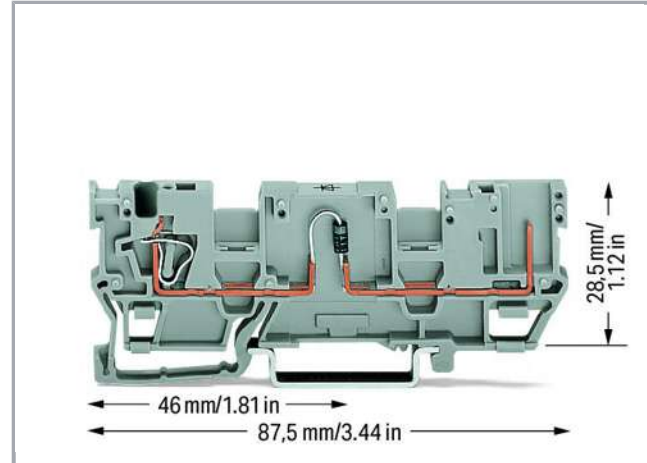
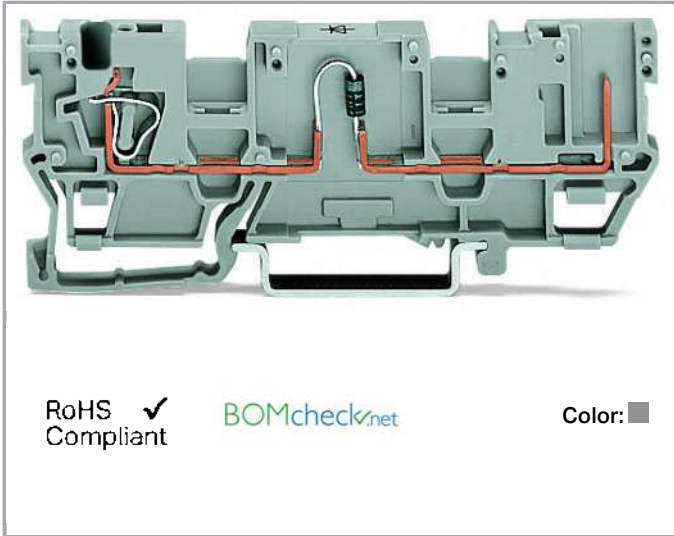

Data

Electrical data

Nominal voltage	250 V
Reverse voltage	1,000 V

Subject to changes. Please also observe the further product documentation!

WAGO Kontakttechnik GmbH & Co. KG
Hansastr. 27
32423 Minden
Phone: +49571 887-0 | Fax: +49571 887-169
Email: info.de@wago.com | Web: www.wago.com

Do you have any questions about our products?
We are always happy to take your call at +49 (571) 887-44222.

Ratings per IEC/EN 60664-1

Rated current	0.5 A
---------------	-------

Connection data

Connection technology	CAGE CLAMP®
Actuation type	Open Tool Slot
Connectable conductor materials	Copper
Nominal cross section	4 mm ²
Solid conductor	0,08 ... 4 mm ² / 28 ... 12 AWG
Fine-stranded conductor	0,08 ... 4 mm ² / 28 ... 12 AWG
Strip length	8 ... 9 mm / 0.31 ... 0.35 inch
Total number of connection points	1
Total number of potentials	1
Number of levels	1
Type of wiring	Front-entry wiring

Geometrical Data

Width	5 mm / 0.197 inch
Height from upper-edge of DIN-35 rail	28,5 mm / 1.122 inch
Depth	87,5 mm / 3.445 inch

Mechanical data

Design	horizontal
Type of mounting	DIN-35 rail
Marking level	Center marking

Material Data

Color	gray
Insulating material	Polyamide 66 (PA 66)
Fire load	0.173 MJ
Weight	7.9 g

Commercial data



Product Group	18 (X-COM-System)
Packaging type	BOX

Subject to changes. Please also observe the further product documentation!



Country of origin	DE
GTIN	4045454198398
Customs Tariff No.	85369010000

Approvals / Certificates

Country specific Approvals

Logo	Approval	Additional Approval Text	Certificate name
	CCA DEKRA Certification B.V.	EN 60947	NTR NL-7626
	CSA DEKRA Certification B.V.	C22.2 No. 158	1101144
	KEMA/KEUR DEKRA Certification B.V.	EN 60947	2190419.01

Ship Approvals

Logo	Approval	Additional Approval Text	Certificate name
	ABS American Bureau of Shipping	EN 60947	20-HG1941090-PDA
	DNV GL Det Norske Veritas, Germanischer Lloyd	-	TAE00001V2

Counterpart











Compatible products

Subject to changes. Please also observe the further product documentation!

WAGO Kontakttechnik GmbH & Co. KG
 Hansastr. 27
 32423 Minden
 Phone: +49571 887-0 | Fax: +49571 887-169
 Email: info.de@wago.com | Web: www.wago.com

Do you have any questions about our products?
 We are always happy to take your call at +49 (571) 887-44222.

Marking accessories

	Item no.: 2009-145 Mini-WSB Inline; for Smart Printer; 1700 pieces on roll; stretchable 5 - 5.2 mm; plain; snap-on type; white	www.wago.com/2009-145
	Item no.: 2009-145/000-002 Mini-WSB Inline; for Smart Printer; 1700 pieces on roll; stretchable 5 - 5.2 mm; plain; snap-on type; white	www.wago.com/2009-145/000-002
	Item no.: 2009-145/000-005 Mini-WSB Inline; for Smart Printer; 1700 pieces on roll; stretchable 5 - 5.2 mm; plain; snap-on type; red	www.wago.com/2009-145/000-005
	Item no.: 2009-145/000-006 Mini-WSB Inline; for Smart Printer; 1700 pieces on roll; stretchable 5 - 5.2 mm; plain; snap-on type; blue	www.wago.com/2009-145/000-006
	Item no.: 2009-145/000-007 Mini-WSB Inline; for Smart Printer; 1700 pieces on roll; stretchable 5 - 5.2 mm; plain; snap-on type; white	www.wago.com/2009-145/000-007
	Item no.: 2009-145/000-012 Mini-WSB Inline; for Smart Printer; 1700 pieces on roll; stretchable 5 - 5.2 mm; plain; snap-on type; orange	www.wago.com/2009-145/000-012
	Item no.: 2009-145/000-023 Mini-WSB Inline; for Smart Printer; 1700 pieces on roll; stretchable 5 - 5.2 mm; plain; snap-on type; green	www.wago.com/2009-145/000-023
	Item no.: 2009-145/000-024 Mini-WSB Inline; for Smart Printer; 1700 pieces on roll; stretchable 5 - 5.2 mm; plain; snap-on type; violet	www.wago.com/2009-145/000-024
	Item no.: 248-501 Miniature WSB Quick marking system; plain; Marker width 5 mm; 10 strips with 10 markers per card	www.wago.com/248-501
	Item no.: 248-501/000-002 Mini-WSB marking card; as card; not stretchable; plain; snap-on type; yellow	www.wago.com/248-501/000-002
	Item no.: 248-501/000-005 Mini-WSB marking card; as card; not stretchable; plain; snap-on type; red	www.wago.com/248-501/000-005

Subject to changes. Please also observe the further product documentation!



Item no.: 248-501/000-006
Mini-WSB marking card; as card; not stretchable; plain; snap-on type; blue

www.wago.com/248-501/000-006



Item no.: 248-501/000-007
Mini-WSB marking card; as card; not stretchable; plain; snap-on type; gray

www.wago.com/248-501/000-007



Item no.: 248-501/000-012
Mini-WSB marking card; as card; not stretchable; plain; snap-on type; orange

www.wago.com/248-501/000-012



Item no.: 248-501/000-017
Mini-WSB marking card; as card; not stretchable; plain; snap-on type; light green

www.wago.com/248-501/000-017



Item no.: 248-501/000-023
Mini-WSB marking card; as card; not stretchable; plain; snap-on type; green

www.wago.com/248-501/000-023



Item no.: 248-501/000-024
Mini-WSB marking card; as card; not stretchable; plain; snap-on type; violet

www.wago.com/248-501/000-024

Protective Warning Marker



Item no.: 280-415
Protective warning marker; with high-voltage symbol, black; for 5 terminal blocks; yellow

www.wago.com/280-415

Insulation stop



Item no.: 769-470
Insulation stop; 0.08 - 0.2 mm² "s" (0.14 mm² "f-st"); 5 pieces/strip; white

www.wago.com/769-470



Item no.: 769-471
Insulation stop; 0.25 - 0.5 mm²; 5 pieces/strip; light gray

www.wago.com/769-471



Item no.: 769-472
Insulation stop; 0.75 - 1 mm²; 5 pieces/strip; dark gray

www.wago.com/769-472

check



Item no.: 210-136
Test plug; 2 mm Ø; with 500 mm cable; red

www.wago.com/210-136



Item no.: 210-137
Test plug; 2.3 mm Ø; with 500 mm cable; yellow

www.wago.com/210-137



Item no.: 280-404
Test plug adapter; 5 mm wide; for test plug 210-137 (2.3 mm Ø); suitable for 1.5 mm² - 4 mm² tbs; gray

www.wago.com/280-404



Item no.: 280-418
Test plug module; modular; suitable for all WAGO 280 and 780 Series rail-mounted terminal blocks with jumper slots in the current bar; gray

www.wago.com/280-418

Item no.: 280-419
Spacer module; modular; bridging commoned terminal blocks; gray

www.wago.com/280-419

Subject to changes. Please also observe the further product documentation!



assembling



Item no.: 209-106
Mounting carrier; for isolated mounting on DIN 35 rails; gray

www.wago.com/209-106

Carrier rail



Item no.: 210-112
Steel carrier rail; 35 x 7.5 mm; 1 mm thick; 2 m long; slotted; according to EN 60715; "Hole width 25 mm" www.wago.com/210-112



Item no.: 210-113
Steel carrier rail; 35 x 7.5 mm; 1 mm thick; 2 m long; unslotted; according to EN 60715 www.wago.com/210-113



Item no.: 210-114
Steel carrier rail; 35 x 15 mm; 1.5 mm thick; 2 m long; unslotted; similar to EN 60715 www.wago.com/210-114



Item no.: 210-115
Steel carrier rail; 35 x 7.5 mm; 1 mm thick; 2 m long; slotted; according to EN 60715; "Hole width 18 mm" www.wago.com/210-115



Item no.: 210-118
Steel carrier rail; 35 x 15 mm; 2.3 mm thick; 2 m long; unslotted; according to EN 60715 www.wago.com/210-118



Item no.: 210-196
Aluminum carrier rail; 35 x 8.2 mm; 1.6 mm thick; 2 m long; unslotted; similar to EN 60715; silver-colored www.wago.com/210-196



Item no.: 210-197
Steel carrier rail; 35 x 15 mm; 1.5 mm thick; 2 m long; slotted; similar to EN 60715 www.wago.com/210-197



Item no.: 210-198
Copper carrier rail; 35 x 15 mm; 2.3 mm thick; 2 m long; unslotted; according to EN 60715; copper-colored www.wago.com/210-198



Item no.: 210-504
Steel carrier rail; 35 x 7.5 mm; 1 mm thick; 2 m long; slotted; galvanized; according to EN 60715 www.wago.com/210-504



Item no.: 210-505
Steel carrier rail; 35 x 7.5 mm; 1 mm thick; 2 m long; unslotted; galvanized; according to EN 60715 www.wago.com/210-505



Item no.: 210-506
Steel carrier rail; 35 x 15 mm; 1.5 mm thick; 2 m long; unslotted; galvanized; similar to EN 60715 www.wago.com/210-506



Item no.: 210-508
Steel carrier rail; 35 x 15 mm; 1.5 mm thick; 2 m long; slotted; galvanized; similar to EN 60715 www.wago.com/210-508

General accessories



Item no.: 769-438
Pin cover; with marker slot for miniature WSB; gray

www.wago.com/769-438

















Item no.: 769-439
Pin cover; with marker slot for miniature WSB; orange

www.wago.com/769-439

Item no.: 769-501

Subject to changes. Please also observe the further product documentation!

	Start module for 1-conductor female connector; with integrated end plate; 4 mm ² ; 1-pole; 4,00 mm ² ; www.wago.com/769-501 gray	
	Item no.: 769-501/000-006 Start module for 1-conductor female connector; 4 mm ² ; 1-pole; 4,00 mm ² ; blue	www.wago.com/769-501/000-006
	Item no.: 769-501/000-016 Start module for 1-conductor female connector; with integrated end plate; 4 mm ² ; 1-pole; 4,00 mm ² ; green-yellow	www.wago.com/769-501/000-016
	Item no.: 769-502 Center module for 1-conductor female connector; 4 mm ² ; 1-pole; 4,00 mm ² ; gray	www.wago.com/769-502
	Item no.: 769-502/000-006 Center module for 1-conductor female connector; 4 mm ² ; 1-pole; 4,00 mm ² ; blue	www.wago.com/769-502/000-006
	Item no.: 769-502/000-016 Center module for 1-conductor female connector; 4 mm ² ; 1-pole; 4,00 mm ² ; green-yellow	www.wago.com/769-502/000-016
	Item no.: 769-503 End module for 1-conductor female connector; 4 mm ² ; 1-pole; 4,00 mm ² ; gray	www.wago.com/769-503
	Item no.: 769-503/000-006 End module for 1-conductor female connector; 4 mm ² ; 1-pole; 4,00 mm ² ; blue	www.wago.com/769-503/000-006
	Item no.: 769-503/000-016 End module for 1-conductor female connector; 4 mm ² ; 1-pole; 4,00 mm ² ; green-yellow	www.wago.com/769-503/000-016
	Item no.: 769-504 Start module for 2-conductor female connector; with integrated end plate; 4 mm ² ; 1-pole; 4,00 mm ² ; gray	www.wago.com/769-504
	Item no.: 769-504/000-006 Start module for 2-conductor female connector; with integrated end plate; 4 mm ² ; 1-pole; 4,00 mm ² ; blue	www.wago.com/769-504/000-006
	Item no.: 769-504/000-016 Start module for 2-conductor female connector; 4 mm ² ; 1-pole; 4,00 mm ² ; green-yellow	www.wago.com/769-504/000-016
	Item no.: 769-505 Center module for 2-conductor female connector; 4 mm ² ; 1-pole; 4,00 mm ² ; gray	www.wago.com/769-505
	Item no.: 769-505/000-006 Center module for 2-conductor female connector; 4 mm ² ; 1-pole; 4,00 mm ² ; blue	www.wago.com/769-505/000-006
	Item no.: 769-505/000-016 Center module for 2-conductor female connector; 4 mm ² ; 1-pole; 4,00 mm ² ; green-yellow	www.wago.com/769-505/000-016

Subject to changes. Please also observe the further product documentation!



Item no.: 769-506

End module for 2-conductor female connector; 4 mm²; 1-pole; 4,00 mm²; gray

www.wago.com/769-506



Item no.: 769-506/000-006

End module for 2-conductor female connector; 4 mm²; 1-pole; 4,00 mm²; blue

www.wago.com/769-506/000-006



Item no.: 769-506/000-016

End module for 2-conductor female connector; 4 mm²; 1-pole; 4,00 mm²; green-yellow

www.wago.com/769-506/000-016



Item no.: 769-512

Start module for 1-conductor female connector; angled; 4 mm²; 1-pole; 4,00 mm²; gray

www.wago.com/769-512



Item no.: 769-512/000-006

Start module for 1-conductor female connector; angled; 4 mm²; 1-pole; 4,00 mm²; blue

www.wago.com/769-512/000-006



Item no.: 769-512/000-016

Start module for 1-conductor female connector; angled; 4 mm²; 1-pole; 4,00 mm²; green-yellow

www.wago.com/769-512/000-016



Item no.: 769-513

Center module for 1-conductor female connector; angled; 4 mm²; 1-pole; 4,00 mm²; gray

www.wago.com/769-513



Item no.: 769-513/000-006

Center module for 1-conductor female connector; angled; 4 mm²; 1-pole; 4,00 mm²; blue

www.wago.com/769-513/000-006



Item no.: 769-513/000-016

Center module for 1-conductor female connector; angled; 4 mm²; 1-pole; 4,00 mm²; green-yellow

www.wago.com/769-513/000-016



Item no.: 769-515

End module for 1-conductor female connector; angled; 4 mm²; 1-pole; 4,00 mm²; gray

www.wago.com/769-515



Item no.: 769-515/000-006

End module for 1-conductor female connector; angled; 4 mm²; 1-pole; 4,00 mm²; blue

www.wago.com/769-515/000-006



Item no.: 769-515/000-016

End module for 1-conductor female connector; angled; 4 mm²; 1-pole; 4,00 mm²; green-yellow

www.wago.com/769-515/000-016

ferrule



Item no.: 216-101

Ferrule; Sleeve for 0.5 mm² / AWG 22; uninsulated; electro-tin plated

www.wago.com/216-101



Item no.: 216-102

Ferrule; Sleeve for 0.75 mm² / AWG 20; uninsulated; electro-tin plated

www.wago.com/216-102

Subject to changes. Please also observe the further product documentation!

WAGO Kontakttechnik GmbH & Co. KG

Hansastr. 27















32423 Minden

Phone: +49571 887-0 | Fax: +49571 887-169

Email: info.de@wago.com | Web: www.wago.com

Do you have any questions about our products?

We are always happy to take your call at +49 (571) 887-44222.

	Item no.: 216-103 Ferrule; Sleeve for 1 mm ² / AWG 18; uninsulated; electro-tin plated	www.wago.com/216-103
	Item no.: 216-104 Ferrule; Sleeve for 1.5 mm ² / AWG 16; uninsulated; electro-tin plated	www.wago.com/216-104
	Item no.: 216-201 Ferrule; Sleeve for 0.5 mm ² / 20 AWG; insulated; electro-tin plated; white	www.wago.com/216-201
	Item no.: 216-202 Ferrule; Sleeve for 0.75 mm ² / 18 AWG; insulated; electro-tin plated; gray	www.wago.com/216-202
	Item no.: 216-203 Ferrule; Sleeve for 1 mm ² / AWG 18; insulated; electro-tin plated; red	www.wago.com/216-203
	Item no.: 216-204 Ferrule; Sleeve for 1.5 mm ² / AWG 16; insulated; electro-tin plated; black	www.wago.com/216-204
	Item no.: 216-206 Ferrule; Sleeve for 2.5 mm ² / AWG 14; insulated; electro-tin plated; blue	www.wago.com/216-206
	Item no.: 216-301 Ferrule; Sleeve for 0.25 mm ² / AWG 24; insulated; electro-tin plated; yellow	www.wago.com/216-301
	Item no.: 216-302 Ferrule; Sleeve for 0.34 mm ² / 22 AWG; insulated; electro-tin plated; green	www.wago.com/216-302
Coding		
	Item no.: 769-435 Coding pin; for coding of female plugs; for carrier terminal blocks / male connectors; orange	www.wago.com/769-435
Female plug		
	Item no.: 769-101 1-conductor female plug; 4 mm ² ; 1-pole; 4,00 mm ² ; gray	www.wago.com/769-101
	Item no.: 769-101/000-006 1-conductor female plug; 4 mm ² ; 1-pole; 4,00 mm ² ; blue	www.wago.com/769-101/000-006
	Item no.: 769-101/000-016 1-conductor female plug; 4 mm ² ; 1-pole; 4,00 mm ² ; green-yellow	www.wago.com/769-101/000-016
	Item no.: 769-101/022-000 1-conductor female plug; angled; 4 mm ² ; 1-pole; 4,00 mm ² ; gray	www.wago.com/769-101/022-000
	Item no.: 769-101/022-016 1-conductor female plug; angled; 4 mm ² ; 1-pole; 4,00 mm ² ; green-yellow	www.wago.com/769-101/022-016
	Item no.: 769-102 1-conductor female plug; 4 mm ² ; 2-pole; 4,00 mm ² ; gray	www.wago.com/769-102

Subject to changes. Please also observe the further product documentation!



Item no.: 769-102/000-006
1-conductor female plug; 4 mm²; 2-pole; 4,00 mm²; blue

www.wago.com/769-102/000-006



Item no.: 769-102/000-036
1-conductor female plug; 4 mm²; 2-pole; 4,00 mm²; gray, green-yellow

www.wago.com/769-102/000-036



Item no.: 769-102/000-037
1-conductor female plug; 4 mm²; 2-pole; 4,00 mm²; green-yellow, gray

www.wago.com/769-102/000-037



Item no.: 769-102/022-000
1-conductor female plug; angled; 4 mm²; 2-pole; 4,00 mm²; gray

www.wago.com/769-102/022-000



Item no.: 769-103
1-conductor female plug; 4 mm²; 3-pole; 4,00 mm²; gray

www.wago.com/769-103



Item no.: 769-103/000-006
1-conductor female plug; 4 mm²; 3-pole; 4,00 mm²; blue

www.wago.com/769-103/000-006



Item no.: 769-103/000-036
1-conductor female plug; 4 mm²; 3-pole; 4,00 mm²; gray, green-yellow

www.wago.com/769-103/000-036



Item no.: 769-103/000-037
1-conductor female plug; 4 mm²; 3-pole; 4,00 mm²; green-yellow, gray

www.wago.com/769-103/000-037



Item no.: 769-103/000-038
1-conductor female plug; 4 mm²; 3-pole; 4,00 mm²; gray, blue, green-yellow

www.wago.com/769-103/000-038



Item no.: 769-103/000-039
1-conductor female plug; 4 mm²; 3-pole; 4,00 mm²; green-yellow, blue, gray

www.wago.com/769-103/000-039



Item no.: 769-103/022-000
1-conductor female plug; angled; 4 mm²; 3-pole; 4,00 mm²; gray

www.wago.com/769-103/022-000



Item no.: 769-104
1-conductor female plug; 4 mm²; 4-pole; 4,00 mm²; gray

www.wago.com/769-104



Item no.: 769-104/000-006
1-conductor female plug; 4 mm²; 4-pole; 4,00 mm²; blue















www.wago.com/769-104/000-006

















Item no.: 769-104/000-036
1-conductor female plug; 4 mm²; 4-pole; 4,00 mm²; gray, green-yellow

www.wago.com/769-104/000-036















Subject to changes. Please also observe the further product documentation!

	Item no.: 769-104/000-037 1-conductor female plug; 4 mm ² ; 4-pole; 4,00 mm ² ; green-yellow, gray	www.wago.com/769-104/000-037
	Item no.: 769-104/000-038 1-conductor female plug; 4 mm ² ; 4-pole; 4,00 mm ² ; gray, blue, green-yellow	www.wago.com/769-104/000-038
	Item no.: 769-104/000-039 1-conductor female plug; 4 mm ² ; 4-pole; 4,00 mm ² ; green-yellow, blue, gray	www.wago.com/769-104/000-039
	Item no.: 769-104/022-000 1-conductor female plug; angled; 4 mm ² ; 4-pole; 4,00 mm ² ; gray	www.wago.com/769-104/022-000
	Item no.: 769-105 1-conductor female plug; 4 mm ² ; 5-pole; 4,00 mm ² ; gray	www.wago.com/769-105
	Item no.: 769-105/000-006 1-conductor female plug; 4 mm ² ; 5-pole; 4,00 mm ² ; blue	www.wago.com/769-105/000-006
	Item no.: 769-105/000-036 1-conductor female plug; 4 mm ² ; 5-pole; 4,00 mm ² ; gray, green-yellow	www.wago.com/769-105/000-036
	Item no.: 769-105/000-037 1-conductor female plug; 4 mm ² ; 5-pole; 4,00 mm ² ; green-yellow, gray	www.wago.com/769-105/000-037
	Item no.: 769-105/000-038 1-conductor female plug; 4 mm ² ; 5-pole; 4,00 mm ² ; gray, blue, green-yellow	www.wago.com/769-105/000-038
	Item no.: 769-105/000-039 1-conductor female plug; 4 mm ² ; 5-pole; 4,00 mm ² ; green-yellow, blue, gray	www.wago.com/769-105/000-039
	Item no.: 769-105/022-000 1-conductor female plug; angled; 4 mm ² ; 5-pole; 4,00 mm ² ; gray	www.wago.com/769-105/022-000
	Item no.: 769-106 1-conductor female plug; 4 mm ² ; 6-pole; 4,00 mm ² ; gray	www.wago.com/769-106
	Item no.: 769-106/000-006 1-conductor female plug; 4 mm ² ; 6-pole; 4,00 mm ² ; blue	www.wago.com/769-106/000-006
	Item no.: 769-106/000-036 1-conductor female plug; 4 mm ² ; 6-pole; 4,00 mm ² ; gray, green-yellow	www.wago.com/769-106/000-036















Subject to changes. Please also observe the further product documentation!

	Item no.: 769-106/000-037 1-conductor female plug; 4 mm²; 6-pole; 4,00 mm²; green-yellow, gray	www.wago.com/769-106/000-037
	Item no.: 769-106/000-038 1-conductor female plug; 4 mm²; 6-pole; 4,00 mm²; gray, blue, green-yellow	www.wago.com/769-106/000-038
	Item no.: 769-106/000-039 1-conductor female plug; 4 mm²; 6-pole; 4,00 mm²; green-yellow, blue, gray	www.wago.com/769-106/000-039
	Item no.: 769-106/022-000 1-conductor female plug; angled; 4 mm²; 6-pole; 4,00 mm²; gray	www.wago.com/769-106/022-000
	Item no.: 769-107 1-conductor female plug; 4 mm²; 7-pole; 4,00 mm²; gray	www.wago.com/769-107
	Item no.: 769-107/000-006 1-conductor female plug; 4 mm²; 7-pole; 4,00 mm²; blue	www.wago.com/769-107/000-006
	Item no.: 769-107/000-036 1-conductor female plug; 4 mm²; 7-pole; 4,00 mm²; gray, green-yellow	www.wago.com/769-107/000-036
	Item no.: 769-107/000-037 1-conductor female plug; 4 mm²; 7-pole; 4,00 mm²; green-yellow, gray	www.wago.com/769-107/000-037
	Item no.: 769-107/000-038 1-conductor female plug; 4 mm²; 7-pole; 4,00 mm²; gray, blue, green-yellow	www.wago.com/769-107/000-038
	Item no.: 769-107/000-039 1-conductor female plug; 4 mm²; 7-pole; 4,00 mm²; green-yellow, blue, gray	www.wago.com/769-107/000-039
	Item no.: 769-107/022-000 1-conductor female plug; angled; 4 mm²; 7-pole; 4,00 mm²; gray	www.wago.com/769-107/022-000
	Item no.: 769-108 1-conductor female plug; 4 mm²; 8-pole; 4,00 mm²; gray	www.wago.com/769-108
	Item no.: 769-108/000-006 1-conductor female plug; 4 mm²; 8-pole; 4,00 mm²; blue	www.wago.com/769-108/000-006
	Item no.: 769-108/000-036 1-conductor female plug; 4 mm²; 8-pole; 4,00 mm²; gray, green-yellow	www.wago.com/769-108/000-036















Subject to changes. Please also observe the further product documentation!

	Item no.: 769-108/000-037 1-conductor female plug; 4 mm ² ; 8-pole; 4,00 mm ² ; green-yellow, gray	www.wago.com/769-108/000-037
	Item no.: 769-108/000-038 1-conductor female plug; 4 mm ² ; 8-pole; 4,00 mm ² ; gray, blue, green-yellow	www.wago.com/769-108/000-038
	Item no.: 769-108/000-039 1-conductor female plug; 4 mm ² ; 8-pole; 4,00 mm ² ; green-yellow, blue, gray	www.wago.com/769-108/000-039
	Item no.: 769-108/022-000 1-conductor female plug; angled; 4 mm ² ; 8-pole; 4,00 mm ² ; gray	www.wago.com/769-108/022-000
	Item no.: 769-109 1-conductor female plug; 4 mm ² ; 9-pole; 4,00 mm ² ; gray	www.wago.com/769-109
	Item no.: 769-109/000-006 1-conductor female plug; 4 mm ² ; 9-pole; 4,00 mm ² ; blue	www.wago.com/769-109/000-006
	Item no.: 769-109/000-036 1-conductor female plug; 4 mm ² ; 9-pole; 4,00 mm ² ; gray, green-yellow	www.wago.com/769-109/000-036
	Item no.: 769-109/000-037 1-conductor female plug; 4 mm ² ; 9-pole; 4,00 mm ² ; green-yellow, gray	www.wago.com/769-109/000-037
	Item no.: 769-109/000-038 1-conductor female plug; 4 mm ² ; 9-pole; 4,00 mm ² ; gray, blue, green-yellow	www.wago.com/769-109/000-038
	Item no.: 769-109/000-039 1-conductor female plug; 4 mm ² ; 9-pole; 4,00 mm ² ; green-yellow, blue, gray	www.wago.com/769-109/000-039
	Item no.: 769-109/022-000 1-conductor female plug; angled; 4 mm ² ; 9-pole; 4,00 mm ² ; gray	www.wago.com/769-109/022-000
	Item no.: 769-110 1-conductor female plug; 4 mm ² ; 10-pole; 4,00 mm ² ; gray	www.wago.com/769-110
	Item no.: 769-110/000-006 1-conductor female plug; 4 mm ² ; 10-pole; 4,00 mm ² ; blue	www.wago.com/769-110/000-006
	Item no.: 769-110/000-036 1-conductor female plug; 4 mm ² ; 10-pole; 4,00 mm ² ; gray, green-yellow	www.wago.com/769-110/000-036















Subject to changes. Please also observe the further product documentation!

	Item no.: 769-110/000-037 1-conductor female plug; 4 mm ² ; 10-pole; 4,00 mm ² ; green-yellow, gray	www.wago.com/769-110/000-037
	Item no.: 769-110/000-038 1-conductor female plug; 4 mm ² ; 10-pole; 4,00 mm ² ; gray, blue, green-yellow	www.wago.com/769-110/000-038
	Item no.: 769-110/000-039 1-conductor female plug; 4 mm ² ; 10-pole; 4,00 mm ² ; green-yellow, blue, gray	www.wago.com/769-110/000-039
	Item no.: 769-110/022-000 1-conductor female plug; angled; 4 mm ² ; 10-pole; 4,00 mm ² ; gray	www.wago.com/769-110/022-000
	Item no.: 769-111 1-conductor female plug; 4 mm ² ; 11-pole; 4,00 mm ² ; gray	www.wago.com/769-111
	Item no.: 769-111/000-006 1-conductor female plug; 4 mm ² ; 11-pole; 4,00 mm ² ; blue	www.wago.com/769-111/000-006
	Item no.: 769-111/000-036 1-conductor female plug; 4 mm ² ; 11-pole; 4,00 mm ² ; gray, green-yellow	www.wago.com/769-111/000-036
	Item no.: 769-111/000-037 1-conductor female plug; 4 mm ² ; 11-pole; 4,00 mm ² ; green-yellow, gray	www.wago.com/769-111/000-037
	Item no.: 769-111/000-038 1-conductor female plug; 4 mm ² ; 11-pole; 4,00 mm ² ; gray, blue, green-yellow	www.wago.com/769-111/000-038
	Item no.: 769-111/000-039 1-conductor female plug; 4 mm ² ; 11-pole; 4,00 mm ² ; green-yellow, blue, gray	www.wago.com/769-111/000-039
	Item no.: 769-111/022-000 1-conductor female plug; angled; 4 mm ² ; 11-pole; 4,00 mm ² ; gray	www.wago.com/769-111/022-000
	Item no.: 769-112 1-conductor female plug; 4 mm ² ; 12-pole; 4,00 mm ² ; gray	www.wago.com/769-112
	Item no.: 769-112/000-006 1-conductor female plug; 4 mm ² ; 12-pole; 4,00 mm ² ; blue	www.wago.com/769-112/000-006
	Item no.: 769-112/000-036 1-conductor female plug; 4 mm ² ; 12-pole; 4,00 mm ² ; gray, green-yellow	www.wago.com/769-112/000-036

















Subject to changes. Please also observe the further product documentation!

	<p>Item no.: 769-112/000-037 1-conductor female plug; 4 mm²; 12-pole; 4,00 mm²; green-yellow, gray</p>	www.wago.com/769-112/000-037
	<p>Item no.: 769-112/000-038 1-conductor female plug; 4 mm²; 12-pole; 4,00 mm²; gray, blue, green-yellow</p>	www.wago.com/769-112/000-038
	<p>Item no.: 769-112/000-039 1-conductor female plug; 4 mm²; 12-pole; 4,00 mm²; green-yellow, blue, gray</p>	www.wago.com/769-112/000-039
	<p>Item no.: 769-112/022-000 1-conductor female plug; angled; 4 mm²; 12-pole; 4,00 mm²; gray</p>	www.wago.com/769-112/022-000
	<p>Item no.: 769-113 1-conductor female plug; 4 mm²; 13-pole; 4,00 mm²; gray</p>	www.wago.com/769-113
	<p>Item no.: 769-113/000-036 1-conductor female plug; 4 mm²; 13-pole; 4,00 mm²; gray, green-yellow</p>	www.wago.com/769-113/000-036
	<p>Item no.: 769-113/000-037 1-conductor female plug; 4 mm²; 13-pole; 4,00 mm²; green-yellow, gray</p>	www.wago.com/769-113/000-037
	<p>Item no.: 769-113/000-038 1-conductor female plug; 4 mm²; 13-pole; 4,00 mm²; gray, blue, green-yellow</p>	www.wago.com/769-113/000-038
	<p>Item no.: 769-113/000-039 1-conductor female plug; 4 mm²; 13-pole; 4,00 mm²; green-yellow, blue, gray</p>	www.wago.com/769-113/000-039
	<p>Item no.: 769-113/022-000 1-conductor female plug; angled; 4 mm²; 13-pole; 4,00 mm²; gray</p>	www.wago.com/769-113/022-000
	<p>Item no.: 769-114 1-conductor female plug; 4 mm²; 14-pole; 4,00 mm²; gray</p>	www.wago.com/769-114
	<p>Item no.: 769-114/000-006 1-conductor female plug; 4 mm²; 14-pole; 4,00 mm²; blue</p>	www.wago.com/769-114/000-006
	<p>Item no.: 769-114/000-036 1-conductor female plug; 4 mm²; 14-pole; 4,00 mm²; gray, green-yellow</p>	www.wago.com/769-114/000-036
	<p>Item no.: 769-114/000-037 1-conductor female plug; 4 mm²; 14-pole; 4,00 mm²; green-yellow, gray</p>	www.wago.com/769-114/000-037

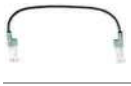



Subject to changes. Please also observe the further product documentation!

	Item no.: 769-114/000-038 1-conductor female plug; 4 mm ² ; 14-pole; 4,00 mm ² ; gray, blue, green-yellow	www.wago.com/769-114/000-038
	Item no.: 769-114/000-039 1-conductor female plug; 4 mm ² ; 14-pole; 4,00 mm ² ; green-yellow, blue, gray	www.wago.com/769-114/000-039
	Item no.: 769-114/022-000 1-conductor female plug; angled; 4 mm ² ; 14-pole; 4,00 mm ² ; gray	www.wago.com/769-114/022-000
	Item no.: 769-115 1-conductor female plug; 4 mm ² ; 15-pole; 4,00 mm ² ; gray	www.wago.com/769-115
	Item no.: 769-115/000-036 1-conductor female plug; 4 mm ² ; 15-pole; 4,00 mm ² ; gray, green-yellow	www.wago.com/769-115/000-036
	Item no.: 769-115/000-037 1-conductor female plug; 4 mm ² ; 15-pole; 4,00 mm ² ; green-yellow, gray	www.wago.com/769-115/000-037
	Item no.: 769-115/000-038 1-conductor female plug; 4 mm ² ; 15-pole; 4,00 mm ² ; gray, blue, green-yellow	www.wago.com/769-115/000-038
	Item no.: 769-115/000-039 1-conductor female plug; 4 mm ² ; 15-pole; 4,00 mm ² ; green-yellow, blue, gray	www.wago.com/769-115/000-039
	Item no.: 769-115/022-000 1-conductor female plug; angled; 4 mm ² ; 15-pole; 4,00 mm ² ; gray	www.wago.com/769-115/022-000
	Item no.: 769-121 2-conductor female connector; 4 mm ² ; 1-pole; 4,00 mm ² ; gray	www.wago.com/769-121
	Item no.: 769-121/000-016 2-conductor female connector; 4 mm ² ; 1-pole; 4,00 mm ² ; green-yellow	www.wago.com/769-121/000-016
	Item no.: 769-122 2-conductor female connector; 4 mm ² ; 2-pole; 4,00 mm ² ; gray	www.wago.com/769-122
	Item no.: 769-123 2-conductor female connector; 4 mm ² ; 3-pole; 4,00 mm ² ; gray	www.wago.com/769-123
	Item no.: 769-124 2-conductor female connector; 4 mm ² ; 4-pole; 4,00 mm ² ; gray	www.wago.com/769-124
	Item no.: 769-125 2-conductor female connector; 4 mm ² ; 5-pole; 4,00 mm ² ; gray	www.wago.com/769-125

Subject to changes. Please also observe the further product documentation!

	Item no.: 769-126 2-conductor female connector; 4 mm ² ; 6-pole; 4,00 mm ² ; gray	www.wago.com/769-126
	Item no.: 769-127 2-conductor female connector; 4 mm ² ; 7-pole; 4,00 mm ² ; gray	www.wago.com/769-127
	Item no.: 769-128 2-conductor female connector; 4 mm ² ; 8-pole; 4,00 mm ² ; gray	www.wago.com/769-128
	Item no.: 769-129 2-conductor female connector; 4 mm ² ; 9-pole; 4,00 mm ² ; gray	www.wago.com/769-129
	Item no.: 769-130 2-conductor female connector; 4 mm ² ; 10-pole; 4,00 mm ² ; gray	www.wago.com/769-130
	Item no.: 769-131 2-conductor female connector; 4 mm ² ; 11-pole; 4,00 mm ² ; gray	www.wago.com/769-131
	Item no.: 769-132 2-conductor female connector; 4 mm ² ; 12-pole; 4,00 mm ² ; gray	www.wago.com/769-132
	Item no.: 769-133 2-conductor female connector; 4 mm ² ; 13-pole; 4,00 mm ² ; gray	www.wago.com/769-133
	Item no.: 769-134 2-conductor female connector; 4 mm ² ; 14-pole; 4,00 mm ² ; gray	www.wago.com/769-134
	Item no.: 769-135 2-conductor female connector; 4 mm ² ; 15-pole; 4,00 mm ² ; gray	www.wago.com/769-135
Jumper		
	Item no.: 249-123 Push-in type wire jumper; insulated; wire length 180 mm; Conductor cross section 0.75 mm ²	www.wago.com/249-123
	Item no.: 249-125 Push-in type wire jumper; insulated; wire length 60 mm; Conductor cross section 0.75 mm ²	www.wago.com/249-125
	Item no.: 249-126 Push-in type wire jumper; insulated; wire length 110 mm; Conductor cross section 0.75 mm ²	www.wago.com/249-126
	Item no.: 249-127 Push-in type wire jumper; insulated; wire length 250 mm; Conductor cross section 0.75 mm ²	www.wago.com/249-127
	Item no.: 280-402 Adjacent jumper; insulated; IN = IN terminal block; gray	www.wago.com/280-402
	Item no.: 280-409 Alternate jumper; insulated; IN = IN terminal block; gray	www.wago.com/280-409
	Item no.: 780-452 Staggered jumper; insulated; from 1 to 2; Spacing: 5 mm; suitable for 2-conductor female plugs; gray	www.wago.com/780-452
	Item no.: 780-453 Staggered jumper; insulated; from 1 to 3; Spacing: 5 mm; suitable for 2-conductor female plugs; gray	www.wago.com/780-453



Subject to changes. Please also observe the further product documentation!

	Item no.: 780-454 Staggered jumper; insulated; from 1 to 4; Spacing: 5 mm; suitable for 2-conductor female plugs; gray	www.wago.com/780-454
	Item no.: 780-455 Staggered jumper; insulated; from 1 to 5; Spacing: 5 mm; suitable for 2-conductor female plugs; gray	www.wago.com/780-455
	Item no.: 780-456 Staggered jumper; insulated; from 1 to 6; Spacing: 5 mm; suitable for 2-conductor female plugs; gray	www.wago.com/780-456
	Item no.: 780-457 Staggered jumper; insulated; from 1 to 7; Spacing: 5 mm; suitable for 2-conductor female plugs; gray	www.wago.com/780-457
	Item no.: 780-458 Staggered jumper; insulated; from 1 to 8; Spacing: 5 mm; suitable for 2-conductor female plugs; gray	www.wago.com/780-458

tools

	Item no.: 210-720 Operating tool; Blade: 3.5 x 0.5 mm; with a partially insulated shaft	www.wago.com/210-720
--	---	--

End plate

	Item no.: 769-311 End and intermediate plate; 1.1 mm thick; gray	www.wago.com/769-311
	Item no.: 769-312 End and intermediate plate; 1.1 mm thick; orange	www.wago.com/769-312
	Item no.: 769-314 Separator plate; 1.1 mm thick; oversized; orange	www.wago.com/769-314

Downloads

Documentation

Bid Text

769-218/281-411 GAEB X81 - Datei	Feb 19, 2019	xml 3.3 kB	Download
769-218/281-411 doc - Datei	Oct 2, 2017	doc 25.6 kB	Download

Additional Information

Technical explanations	Apr 3, 2019	pdf 2.1 MB	Download
------------------------	-------------	---------------	----------

CAD/CAE-Data

CAD data

2D/3D Models 769-218/281-411

Subject to changes. Please also observe the further product documentation!

WAGO Kontakttechnik GmbH & Co. KG
Hansastr. 27
32423 Minden
Phone: +49571 887-0 | Fax: +49571 887-169
Email: info.de@wago.com | Web: www.wago.com

Do you have any questions about our products?
We are always happy to take your call at +49 (571) 887-44222.

[URL](#) [Download](#)

CAE data

EPLAN Data Portal 769-218/281-411

[URL](#) [Download](#)

WSCAD Universe 769-218/281-411

[URL](#) [Download](#)

Installation Notes

Assembly

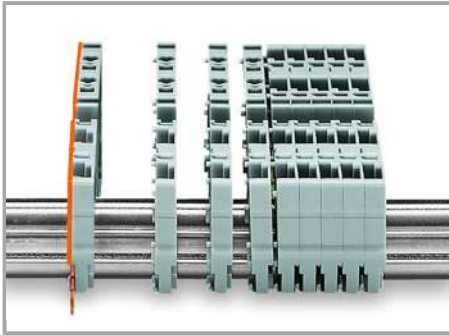

Snap individual carrier terminal blocks onto the carrier rail and slide together.

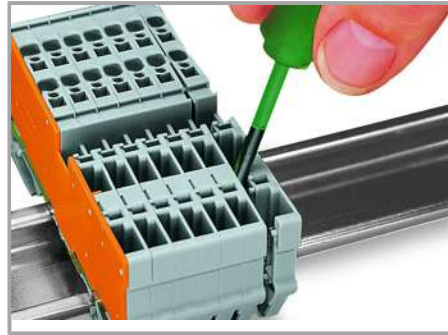

Open the assembly by laterally sliding a block via operating tool and remove terminal block via release lever.

Inserting a conductor

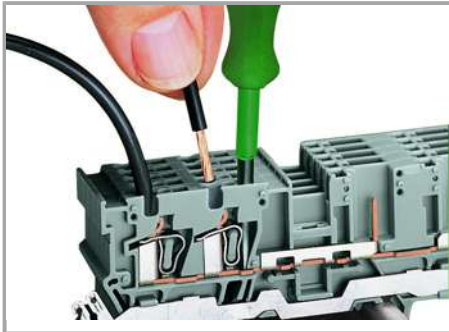

CAGE CLAMP® connection

Carrier terminal block: Insert/remove conductor via operating tool (3.5 x 0.5 mm blade).

Subject to changes. Please also observe the further product documentation!

Jumpered

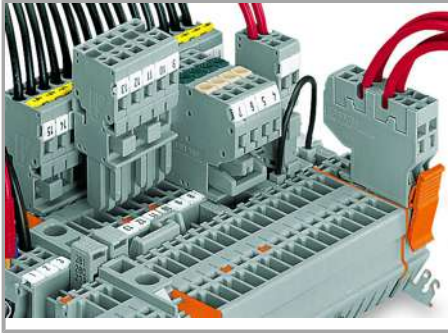

Commoning with adjacent or staggered jumpers –

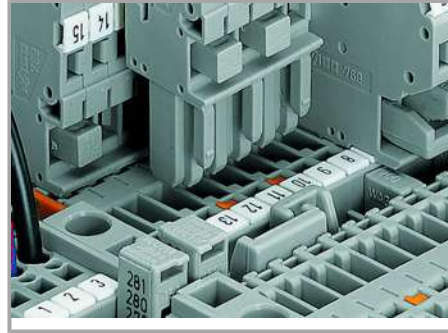

Commoning carrier terminal blocks via staggered jumpers.

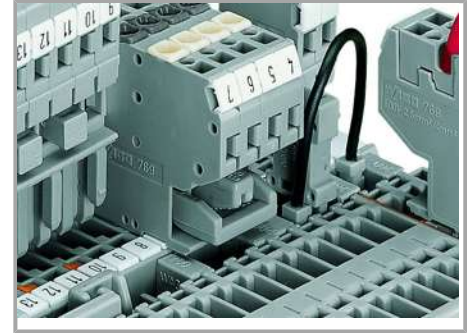

Commoning a 2-conductor female plug via staggered jumper and carrier terminal blocks via adjacent jumpers.

push jumpers down until fully inserted.

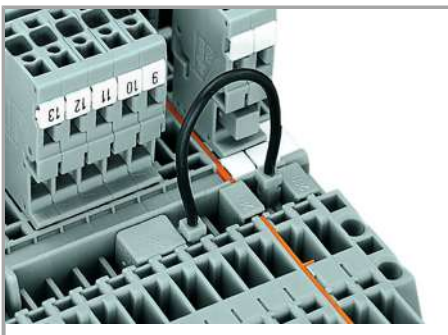

Commoning carrier terminal blocks via push-in type wire jumpers or adjacent jumpers – even over an intermediate plate.

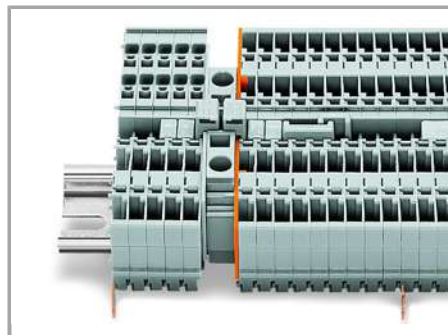

Commoning "supply terminal blocks" (up to 10 mm²/8 AWG) with carrier terminal blocks via step-down jumpers.

Testing

Subject to changes. Please also observe the further product documentation!

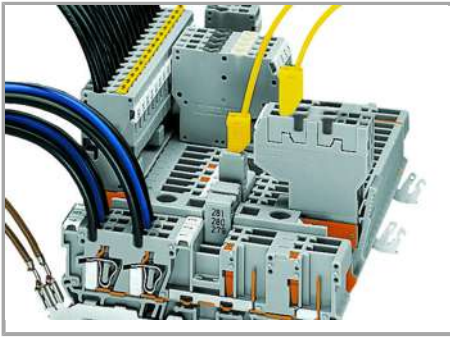

Testing via 2 or 2.3 mm Ø test plugs.

Coding

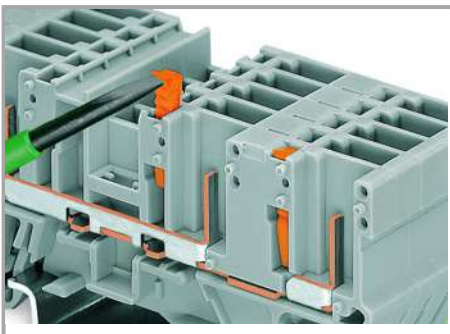

Snap coding pin in proper direction on carrier terminal block.

Shown: Coding pin removal from carrier terminal block.

Locking

Subject to changes. Please also observe the further product documentation!

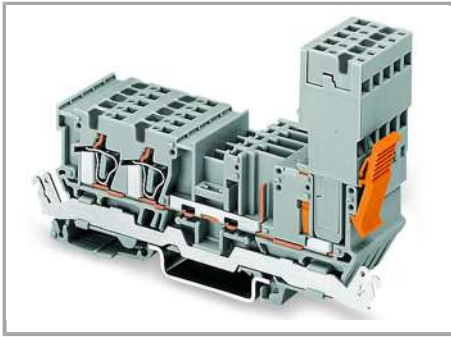

Female plug secured with locking lever on the terminal block side.

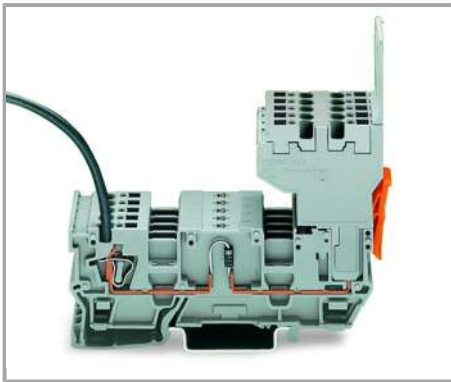

2-conductor female plug

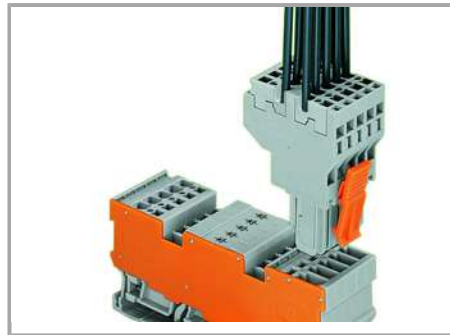

1-conductor/1-pin diode carrier terminal block with two jumper positions

Diode carrier terminal blocks can be commoned via 280 and 780 Series Jumpers and tested using a 280 Series Test Plug Adapter.

2-conductor female plug

Product family

X-COM

[Show all products from the family](#)

Subject to changes. Please also observe the further product documentation!