

## Data sheet | Item number: 769-605/002-000

1-conductor male connector; clamping collar; 4 mm<sup>2</sup>; Pin spacing 5 mm; 5-pole; 4,00 mm<sup>2</sup>; gray

[www.wago.com/769-605\\_002-000](http://www.wago.com/769-605_002-000)

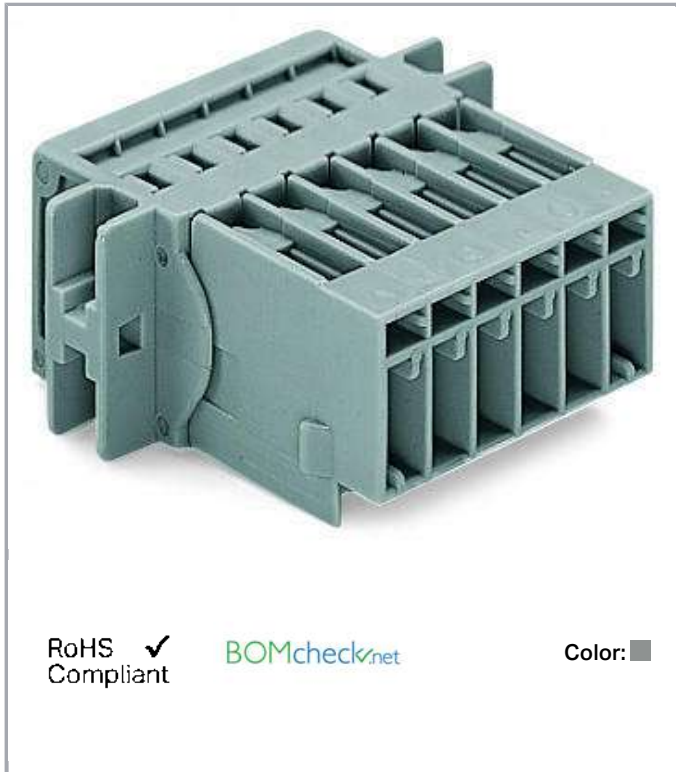

RoHS  Compliant

BOMcheck.net

Color: ■

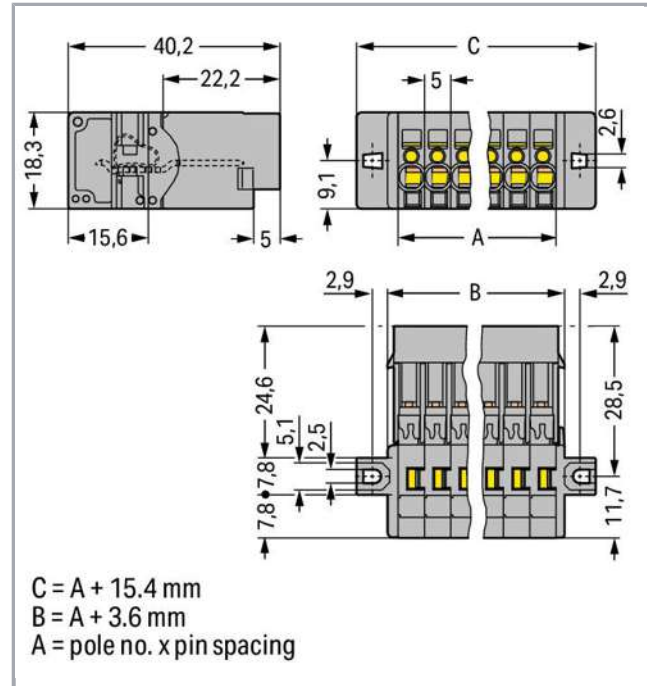

### Data

#### Electrical data

#### Ratings per IEC/EN 60664-1

Rated voltage (III / 3)	500 V
Rated impulse voltage (III / 3)	6 kV
Rated current	32 A
Legend (ratings)	(III / 3) ≙ Overtoltage category III / Pollution degree 3

#### Connection data

Connection technology	CAGE CLAMP®
Actuation type	Operating tool
Connectable conductor materials	Copper

Subject to changes. Please also observe the further product documentation!

WAGO Kontakttechnik GmbH & Co. KG  
Hansastr. 27  
32423 Minden  
Phone: +49571 887-0 | Fax: +49571 887-169  
Email: [info.de@wago.com](mailto:info.de@wago.com) | Web: [www.wago.com](http://www.wago.com)

Do you have any questions about our products?  
We are always happy to take your call at +49 (571) 887-44222.



Nominal cross section	4 mm <sup>2</sup>
Solid conductor	0.08 ... 4 mm <sup>2</sup> / 28 ... 12 AWG
Fine-stranded conductor	0.08 ... 4 mm <sup>2</sup> / 28 ... 12 AWG
Strip length	8 ... 9 mm / 0.31 ... 0.35 inch
No. of poles	5
Total number of connection points	5
Total number of potentials	5
Type of wiring	Front-entry wiring

### Geometrical Data

Pin spacing	5 mm / 0.197 inch
Width	40.4 mm / 1.591 inch
Height from the surface	18.3 mm / 0.72 inch
Depth	40.2 mm / 1.583 inch

### Mechanical data

Mounting type	Mounting flange
---------------	-----------------

### Plug connection

Contact type (pluggable connector)	Male connector/plug
Connector connection type	for conductors

### Material Data

Color	gray
Insulating material	Polyamide 66 (PA 66)
Fire load	0.34 MJ
Weight	16.3 g

### Commercial data

Product Group	18 (X-COM-System)
Packaging type	BOX
Country of origin	PL
GTIN	4044918521055
Customs Tariff No.	85366990990





Subject to changes. Please also observe the further product documentation!

WAGO Kontakttechnik GmbH & Co. KG  
 Hansastr. 27  
 32423 Minden  
 Phone: +49571 887-0 | Fax: +49571 887-169  
 Email: [info.de@wago.com](mailto:info.de@wago.com) | Web: [www.wago.com](http://www.wago.com)

Do you have any questions about our products?  
 We are always happy to take your call at +49 (571) 887-44222.

## Approvals / Certificates



### Country specific Approvals

Logo	Approval	Additional Approval Text	Certificate name
	CCA DEKRA Certification B.V.	EN 60947	NTR NL-7626
	CCA DEKRA Certification B.V.	EN 61984	2190419.02
	CSA DEKRA Certification B.V.	C22.2 No. 158	1101144
	KEMA/KEUR DEKRA Certification B.V.	EN 60947	2190419.01

### Ship Approvals

Logo	Approval	Additional Approval Text	Certificate name
	DNV GL Det Norske Veritas, Germanischer Lloyd	-	TAE00001V2

### UL-Approvals

Logo	Approval	Additional Approval Text	Certificate name
	UR Underwriters Laboratories Inc.	UL 1059	20190731-E45172
	UR Underwriters Laboratories Inc.	UL 1977	20151210-E45171

Subject to changes. Please also observe the further product documentation!

## Counterpart



**Item no.769-105**

1-conductor female plug; 4 mm<sup>2</sup>; 5-pole; 4,00 mm<sup>2</sup>; gray

[www.wago.com/769-105](http://www.wago.com/769-105)



**Item no.769-105/021-000**

1-conductor female plug; Locking lever; 4 mm<sup>2</sup>; 5-pole; 4,00 mm<sup>2</sup>; gray

[www.wago.com/769-105/021-000](http://www.wago.com/769-105/021-000)



**Item no.769-125**

2-conductor female connector; 4 mm<sup>2</sup>; 5-pole; 4,00 mm<sup>2</sup>; gray

[www.wago.com/769-125](http://www.wago.com/769-125)

## Compatible products

### Female plug



**Item no.: 769-101**

1-conductor female plug; 4 mm<sup>2</sup>; 1-pole; 4,00 mm<sup>2</sup>; gray

[www.wago.com/769-101](http://www.wago.com/769-101)



**Item no.: 769-101/000-016**

1-conductor female plug; 4 mm<sup>2</sup>; 1-pole; 4,00 mm<sup>2</sup>; green-yellow

[www.wago.com/769-101/000-016](http://www.wago.com/769-101/000-016)



**Item no.: 769-102**

1-conductor female plug; 4 mm<sup>2</sup>; 2-pole; 4,00 mm<sup>2</sup>; gray

[www.wago.com/769-102](http://www.wago.com/769-102)



**Item no.: 769-102/000-036**

1-conductor female plug; 4 mm<sup>2</sup>; 2-pole; 4,00 mm<sup>2</sup>; gray, green-yellow

[www.wago.com/769-102/000-036](http://www.wago.com/769-102/000-036)



**Item no.: 769-102/000-037**

1-conductor female plug; 4 mm<sup>2</sup>; 2-pole; 4,00 mm<sup>2</sup>; green-yellow, gray

[www.wago.com/769-102/000-037](http://www.wago.com/769-102/000-037)

Subject to changes. Please also observe the further product documentation!

WAGO Kontakttechnik GmbH & Co. KG

Hansastr. 27















32423 Minden

Phone: +49571 887-0 | Fax: +49571 887-169

















Email: [info.de@wago.com](mailto:info.de@wago.com) | Web: [www.wago.com](http://www.wago.com)

Do you have any questions about our products?

We are always happy to take your call at +49 (571) 887-44222.

	<b>Item no.: 769-103</b> 1-conductor female plug; 4 mm <sup>2</sup> ; 3-pole; 4,00 mm <sup>2</sup> ; gray	<a href="http://www.wago.com/769-103">www.wago.com/769-103</a>
	<b>Item no.: 769-103/000-036</b> 1-conductor female plug; 4 mm <sup>2</sup> ; 3-pole; 4,00 mm <sup>2</sup> ; gray, green-yellow	<a href="http://www.wago.com/769-103/000-036">www.wago.com/769-103/000-036</a>
	<b>Item no.: 769-103/000-037</b> 1-conductor female plug; 4 mm <sup>2</sup> ; 3-pole; 4,00 mm <sup>2</sup> ; green-yellow, gray	<a href="http://www.wago.com/769-103/000-037">www.wago.com/769-103/000-037</a>
	<b>Item no.: 769-103/000-038</b> 1-conductor female plug; 4 mm <sup>2</sup> ; 3-pole; 4,00 mm <sup>2</sup> ; gray, blue, green-yellow	<a href="http://www.wago.com/769-103/000-038">www.wago.com/769-103/000-038</a>
	<b>Item no.: 769-103/000-039</b> 1-conductor female plug; 4 mm <sup>2</sup> ; 3-pole; 4,00 mm <sup>2</sup> ; green-yellow, blue, gray	<a href="http://www.wago.com/769-103/000-039">www.wago.com/769-103/000-039</a>
	<b>Item no.: 769-104</b> 1-conductor female plug; 4 mm <sup>2</sup> ; 4-pole; 4,00 mm <sup>2</sup> ; gray	<a href="http://www.wago.com/769-104">www.wago.com/769-104</a>
	<b>Item no.: 769-104/000-036</b> 1-conductor female plug; 4 mm <sup>2</sup> ; 4-pole; 4,00 mm <sup>2</sup> ; gray, green-yellow	<a href="http://www.wago.com/769-104/000-036">www.wago.com/769-104/000-036</a>
	<b>Item no.: 769-104/000-037</b> 1-conductor female plug; 4 mm <sup>2</sup> ; 4-pole; 4,00 mm <sup>2</sup> ; green-yellow, gray	<a href="http://www.wago.com/769-104/000-037">www.wago.com/769-104/000-037</a>
	<b>Item no.: 769-104/000-038</b> 1-conductor female plug; 4 mm <sup>2</sup> ; 4-pole; 4,00 mm <sup>2</sup> ; gray, blue, green-yellow	<a href="http://www.wago.com/769-104/000-038">www.wago.com/769-104/000-038</a>
	<b>Item no.: 769-104/000-039</b> 1-conductor female plug; 4 mm <sup>2</sup> ; 4-pole; 4,00 mm <sup>2</sup> ; green-yellow, blue, gray	<a href="http://www.wago.com/769-104/000-039">www.wago.com/769-104/000-039</a>
	<b>Item no.: 769-105/000-036</b> 1-conductor female plug; 4 mm <sup>2</sup> ; 5-pole; 4,00 mm <sup>2</sup> ; gray, green-yellow	<a href="http://www.wago.com/769-105/000-036">www.wago.com/769-105/000-036</a>
	<b>Item no.: 769-105/000-037</b> 1-conductor female plug; 4 mm <sup>2</sup> ; 5-pole; 4,00 mm <sup>2</sup> ; green-yellow, gray	<a href="http://www.wago.com/769-105/000-037">www.wago.com/769-105/000-037</a>
	<b>Item no.: 769-105/000-038</b> 1-conductor female plug; 4 mm <sup>2</sup> ; 5-pole; 4,00 mm <sup>2</sup> ; gray, blue, green-yellow	<a href="http://www.wago.com/769-105/000-038">www.wago.com/769-105/000-038</a>
	<b>Item no.: 769-105/000-039</b> 1-conductor female plug; 4 mm <sup>2</sup> ; 5-pole; 4,00 mm <sup>2</sup> ; green-yellow, blue, gray	<a href="http://www.wago.com/769-105/000-039">www.wago.com/769-105/000-039</a>

Subject to changes. Please also observe the further product documentation!

	<b>Item no.: 769-121</b> 2-conductor female connector; 4 mm <sup>2</sup> ; 1-pole; 4,00 mm <sup>2</sup> ; gray	<a href="http://www.wago.com/769-121">www.wago.com/769-121</a>
	<b>Item no.: 769-122</b> 2-conductor female connector; 4 mm <sup>2</sup> ; 2-pole; 4,00 mm <sup>2</sup> ; gray	<a href="http://www.wago.com/769-122">www.wago.com/769-122</a>
	<b>Item no.: 769-123</b> 2-conductor female connector; 4 mm <sup>2</sup> ; 3-pole; 4,00 mm <sup>2</sup> ; gray	<a href="http://www.wago.com/769-123">www.wago.com/769-123</a>
	<b>Item no.: 769-124</b> 2-conductor female connector; 4 mm <sup>2</sup> ; 4-pole; 4,00 mm <sup>2</sup> ; gray	<a href="http://www.wago.com/769-124">www.wago.com/769-124</a>
<b>Protective Warning Marker</b>		
	<b>Item no.: 280-415</b> Protective warning marker; with high-voltage symbol, black; for 5 terminal blocks; yellow	<a href="http://www.wago.com/280-415">www.wago.com/280-415</a>
<b>ferrule</b>		
	<b>Item no.: 216-101</b> Ferrule; Sleeve for 0.5 mm <sup>2</sup> / AWG 22; uninsulated; electro-tin plated	<a href="http://www.wago.com/216-101">www.wago.com/216-101</a>
	<b>Item no.: 216-102</b> Ferrule; Sleeve for 0.75 mm <sup>2</sup> / AWG 20; uninsulated; electro-tin plated	<a href="http://www.wago.com/216-102">www.wago.com/216-102</a>
	<b>Item no.: 216-103</b> Ferrule; Sleeve for 1 mm <sup>2</sup> / AWG 18; uninsulated; electro-tin plated	<a href="http://www.wago.com/216-103">www.wago.com/216-103</a>
	<b>Item no.: 216-104</b> Ferrule; Sleeve for 1.5 mm <sup>2</sup> / AWG 16; uninsulated; electro-tin plated	<a href="http://www.wago.com/216-104">www.wago.com/216-104</a>
	<b>Item no.: 216-201</b> Ferrule; Sleeve for 0.5 mm <sup>2</sup> / 20 AWG; insulated; electro-tin plated; white	<a href="http://www.wago.com/216-201">www.wago.com/216-201</a>
	<b>Item no.: 216-202</b> Ferrule; Sleeve for 0.75 mm <sup>2</sup> / 18 AWG; insulated; electro-tin plated; gray	<a href="http://www.wago.com/216-202">www.wago.com/216-202</a>
	<b>Item no.: 216-203</b> Ferrule; Sleeve for 1 mm <sup>2</sup> / AWG 18; insulated; electro-tin plated; red	<a href="http://www.wago.com/216-203">www.wago.com/216-203</a>
	<b>Item no.: 216-204</b> Ferrule; Sleeve for 1.5 mm <sup>2</sup> / AWG 16; insulated; electro-tin plated; black	<a href="http://www.wago.com/216-204">www.wago.com/216-204</a>
	<b>Item no.: 216-206</b> Ferrule; Sleeve for 2.5 mm <sup>2</sup> / AWG 14; insulated; electro-tin plated; blue	<a href="http://www.wago.com/216-206">www.wago.com/216-206</a>
<b>Coding</b>		
	<b>Item no.: 769-435</b> Coding pin; for coding of female plugs; for carrier terminal blocks / male connectors; orange	<a href="http://www.wago.com/769-435">www.wago.com/769-435</a>
<b>Strain relief plate</b>		
	<b>Item no.: 769-410</b> Strain relief plate; gray	<a href="http://www.wago.com/769-410">www.wago.com/769-410</a>

Subject to changes. Please also observe the further product documentation!



**Item no.: 769-412**  
Strain relief plate; gray

[www.wago.com/769-412](http://www.wago.com/769-412)

assembling



**Item no.: 769-499**  
Fixing screw M2.5 x 16; and hexagon nut M2.5

[www.wago.com/769-499](http://www.wago.com/769-499)

tools



**Item no.: 210-490**  
Operating tool

[www.wago.com/210-490](http://www.wago.com/210-490)



**Item no.: 769-434**  
Push-button; loose

[www.wago.com/769-434](http://www.wago.com/769-434)

Insulation stop



**Item no.: 769-470**  
Insulation stop; 0.08 - 0.2 mm<sup>2</sup> "s" (0.14 mm<sup>2</sup> "f-st"); 5 pieces/strip; white

[www.wago.com/769-470](http://www.wago.com/769-470)



**Item no.: 769-471**  
Insulation stop; 0.25 - 0.5 mm<sup>2</sup>; 5 pieces/strip; light gray

[www.wago.com/769-471](http://www.wago.com/769-471)



**Item no.: 769-472**  
Insulation stop; 0.75 - 1 mm<sup>2</sup>; 5 pieces/strip; dark gray

[www.wago.com/769-472](http://www.wago.com/769-472)

Marking accessories



**Item no.: 2009-145**  
Mini-WSB Inline; for Smart Printer; 1700 pieces on roll; stretchable 5 - 5.2 mm; plain; snap-on type; white

[www.wago.com/2009-145](http://www.wago.com/2009-145)



**Item no.: 2009-145/000-002**  
Mini-WSB Inline; for Smart Printer; 1700 pieces on roll; stretchable 5 - 5.2 mm; plain; snap-on type; white /000-002

[www.wago.com/2009-145](http://www.wago.com/2009-145)



**Item no.: 2009-145/000-005**  
Mini-WSB Inline; for Smart Printer; 1700 pieces on roll; stretchable 5 - 5.2 mm; plain; snap-on type; red /000-005

[www.wago.com/2009-145](http://www.wago.com/2009-145)



**Item no.: 2009-145/000-006**  
Mini-WSB Inline; for Smart Printer; 1700 pieces on roll; stretchable 5 - 5.2 mm; plain; snap-on type; blue /000-006

[www.wago.com/2009-145](http://www.wago.com/2009-145)



**Item no.: 2009-145/000-007**  
Mini-WSB Inline; for Smart Printer; 1700 pieces on roll; stretchable 5 - 5.2 mm; plain; snap-on type; white /000-007

[www.wago.com/2009-145](http://www.wago.com/2009-145)



**Item no.: 2009-145/000-012**  
Mini-WSB Inline; for Smart Printer; 1700 pieces on roll; stretchable 5 - 5.2 mm; plain; snap-on type; orange

[www.wago.com/2009-145](http://www.wago.com/2009-145)

















**Item no.: 2009-145/000-023**  
Mini-WSB Inline; for Smart Printer; 1700 pieces on roll; stretchable 5 - 5.2 mm; plain; snap-on type; green

[www.wago.com/2009-145](http://www.wago.com/2009-145)

**Item no.: 2009-145/000-024**

Subject to changes. Please also observe the further product documentation!

	Mini-WSB Inline; for Smart Printer; 1700 pieces on roll; stretchable 5 - 5.2 mm; plain; snap-on type; violet	<a href="http://www.wago.com/2009-145/000-024">www.wago.com/2009-145/000-024</a>
	<b>Item no.: 210-831</b> Marking strips; on reel; 2.3 mm wide; plain; Self-adhesive; white	<a href="http://www.wago.com/210-831">www.wago.com/210-831</a>
	<b>Item no.: 210-832</b> Marking strips; on reel; 3 mm wide; plain; Self-adhesive; white	<a href="http://www.wago.com/210-832">www.wago.com/210-832</a>
	<b>Item no.: 210-833</b> Marking strips; on reel; 6 mm wide; plain; Self-adhesive; white	<a href="http://www.wago.com/210-833">www.wago.com/210-833</a>
	<b>Item no.: 210-834</b> Marking strips; on reel; 5 mm wide; plain; Self-adhesive; white	<a href="http://www.wago.com/210-834">www.wago.com/210-834</a>
	<b>Item no.: 248-501</b> Miniature WSB Quick marking system; plain; Marker width 5 mm; 10 strips with 10 markers per card	<a href="http://www.wago.com/248-501">www.wago.com/248-501</a>
	<b>Item no.: 248-501/000-002</b> Mini-WSB marking card; as card; not stretchable; plain; snap-on type; yellow	<a href="http://www.wago.com/248-501/000-002">www.wago.com/248-501/000-002</a>
	<b>Item no.: 248-501/000-005</b> Mini-WSB marking card; as card; not stretchable; plain; snap-on type; red	<a href="http://www.wago.com/248-501/000-005">www.wago.com/248-501/000-005</a>
	<b>Item no.: 248-501/000-006</b> Mini-WSB marking card; as card; not stretchable; plain; snap-on type; blue	<a href="http://www.wago.com/248-501/000-006">www.wago.com/248-501/000-006</a>
	<b>Item no.: 248-501/000-007</b> Mini-WSB marking card; as card; not stretchable; plain; snap-on type; gray	<a href="http://www.wago.com/248-501/000-007">www.wago.com/248-501/000-007</a>
	<b>Item no.: 248-501/000-012</b> Mini-WSB marking card; as card; not stretchable; plain; snap-on type; orange	<a href="http://www.wago.com/248-501/000-012">www.wago.com/248-501/000-012</a>
	<b>Item no.: 248-501/000-017</b> Mini-WSB marking card; as card; not stretchable; plain; snap-on type; light green	<a href="http://www.wago.com/248-501/000-017">www.wago.com/248-501/000-017</a>
	<b>Item no.: 248-501/000-023</b> Mini-WSB marking card; as card; not stretchable; plain; snap-on type; green	<a href="http://www.wago.com/248-501/000-023">www.wago.com/248-501/000-023</a>
	<b>Item no.: 248-501/000-024</b> Mini-WSB marking card; as card; not stretchable; plain; snap-on type; violet	<a href="http://www.wago.com/248-501/000-024">www.wago.com/248-501/000-024</a>

Subject to changes. Please also observe the further product documentation!





## Downloads

### Documentation

#### Bid Text

769-605/002-000 doc - Datei	Oct 4, 2017	doc 25.6 kB	Download
--------------------------------	-------------	----------------	----------

769-605/002-000 GAEB X81 - Datei	Feb 19, 2019	xml 3.3 kB	Download
-------------------------------------	--------------	---------------	----------

#### Additional Information

Technical explanations	Apr 3, 2019	pdf 2.1 MB	Download
------------------------	-------------	---------------	----------

## CAD/CAE-Data

### CAD data

2D/3D Models 769-605/002-000	URL	Download
------------------------------	-----	----------

### CAE data

EPLAN Data Portal 769-605/002-000	URL	Download
-----------------------------------	-----	----------

WSCAD Universe 769-605/002-000	URL	Download
--------------------------------	-----	----------

## Installation Notes

### Assembly

Subject to changes. Please also observe the further product documentation!

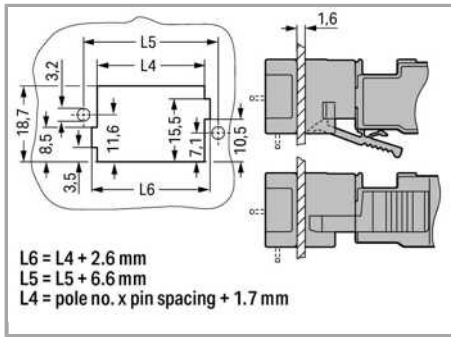

Cutout

Male headers with solder pins and fixing flanges

Inserting a conductor

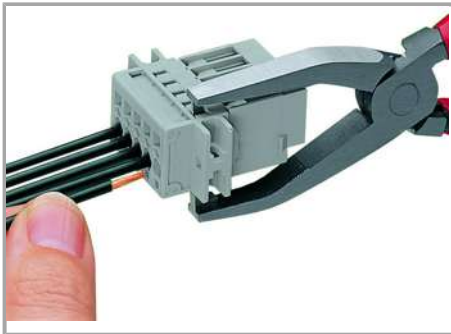

Operating tool

Inserting a conductor via operating tool  
(example shows a male connector).

Application

Subject to changes. Please also observe the further product documentation!

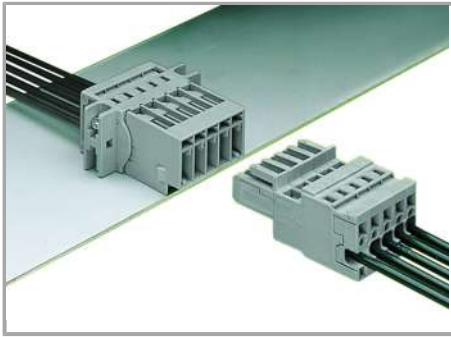

Male connector with CAGE CLAMP® and mounting flanges

1-connector female plug, straight

#### Marking

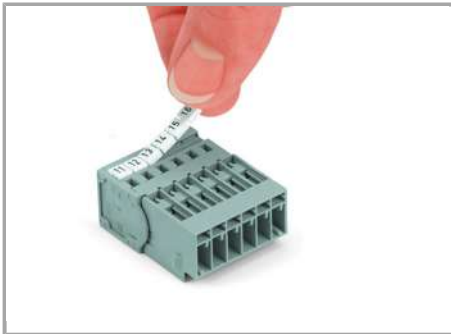

Labeling a male connector with CAGE CLAMP® connection via Mini-WSB quick markers.

#### Product family

**X-COM**

[Show all products from the family](#)

Subject to changes. Please also observe the further product documentation!