

Data sheet | Item number: 771-8995/108-801

pre-assembled connecting cable; Eca; Socket/open-ended; 5-pole; Cod. A;
H05VV-F 5G 4.0 mm²; 8 m; 4,00 mm²; black

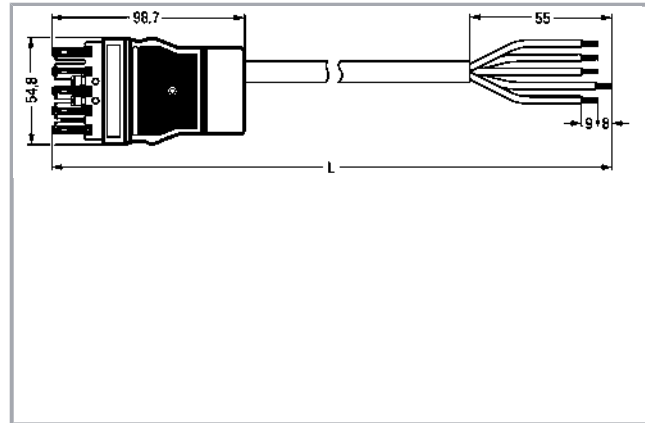

www.wago.com/771-8995_108-801



Item description

- Protected against mismatching and maintenance-free
- Additional variable coding is possible

Note:

Cables with a different fire class can be found in the eShop.

Note on mismatching protection:

All WINSTA[®] components are 100% protected against mismatching when:

- plugging different numbers of poles
- plugging while rotated 180
- plugging while laterally staggered
- plugging one pole

Safety information 1:

Application note for the U.S. market (USR): Some versions may also be used for current interruption in accordance with the UL certificate in select applications with currents below 16 A and voltages up to 600 V. For further information, please contact your local sales office.

Data

Electrical data

Note on Contact Resistance

approx. 1 mΩ of contact resistance approx. 0.25 mΩ contact transition plug/socket

Subject to changes. Please also observe the further product documentation!

WAGO Kontakttechnik GmbH & Co. KG
Hansastr. 27
32423 Minden
Phone: +49571 887-0 | Fax: +49571 887-169
Email: info.de@wago.com | Web: www.wago.com

Do you have any questions about our products?
We are always happy to take your call at +49 (571) 887-44222.

Ratings per IEC/EN 60664-1

Ratings per	IEC/EN 60664-1
Rated voltage (III / 3)	400 V
Rated impulse voltage (III / 3)	6 kV
Rated current	25 A
Legend (ratings)	(III / 3) \triangleq Overvoltage category III / Pollution degree 3

Approvals per UL 1977

Rated voltage per UL 1977 (factory wiring only)	600 V
Rated current per UL 1977 (factory wiring only)	23 A

Connection data

Strip length	9 mm / 0.35 inch
No. of poles	5
Total number of potentials	5
Ground function	with preceding ground contact
Conductor preparation	tip-bonded
Cable diameter	13 ... 16,1 mm
Cross section of single conductor	4 mm ²
Strip length	55 mm
Connection type	Socket - Free end

Geometrical Data

Pin spacing	10 mm / 0.394 inch
Total length	8 m

Mechanical data

Coding	A
Mating force of a plug-in connection	approx. 20 ... 70 N (depending on pole number)
Retention force of a plug-in connection	when locked: > 80N
Unmating force of a plug-in connection	when unlocked: approx. 20 ... 70 N (depending on pole number)
Number of mating cycles	200 (without resistive load) 100 (with resistive load $I_N = 25$ A), tested (4 mm ²)
Connection type	Socket - free end
Type of cable assembly	Connecting cable
Type of cable	H05VV-F 5G4

Subject to changes. Please also observe the further product documentation!



Marking	N L1 L2 L3
Protection class	IP20
Note on protection class	Only when mated (these compact connectors are not designed for use in open, easily accessible areas).
Potential marking	N L1 L2 L3
Application	General mains applications

Plug connection

Mismating protection	Yes
Locking of plug-in connection	locking lever
Locking lever	retrofitable

Material Data

Color	black
Insulating material	Polyamide 66 (PA 66)
Reaction to fire class per EN 50575	E _{ca}
Contact material	Copper or copper alloy (surface-treated)
Fire load	41.31 MJ
Connector color	black
Printing color of mating face	white
Strain relief color	black
Printing color of strain relief	white
Color of sheathed cable	black
Printing color of sheathed cable	white
Sheath material	PVC
Weight	2919.8 g

Environmental Requirements

Processing temperature	-5 ... +40 °C
Continuous operating temperature	-35 ... +85 °C
Note on Continuous Service Temperature	PVC cable for temperatures ≤ 70 °C (including halogen-free) Insulating parts for temperatures ≤ 105 °C

Commercial data

Packaging type	not packed
Country of origin	DE
GTIN	4050821445999

Subject to changes. Please also observe the further product documentation!

WAGO Kontakttechnik GmbH & Co. KG
 Hansastr. 27
 32423 Minden
 Phone: +49571 887-0 | Fax: +49571 887-169
 Email: info.de@wago.com | Web: www.wago.com



Do you have any questions about our products?
 We are always happy to take your call at +49 (571) 887-44222.

Customs Tariff No.

85444290900

Approvals / Certificates





Country specific Approvals

Logo	Approval	Additional Approval Text	Certificate name
	CCA DEKRA Certification B.V.	EN 61535	NTR NL-7355
	KEMA/KEUR DEKRA Certification B.V.	EN 61535	2179129.01



Counterpart

Compatible products

Locking lever

	Item no.: 770-101 Locking lever; for flying leads; for manual operation; black	www.wago.com/770-101
	Item no.: 770-111 Locking lever; for flying leads; for tool operation; black	www.wago.com/770-111
	Item no.: 770-121 Locking lever; for flying leads; for manual operation; white	www.wago.com/770-121
	Item no.: 770-131 Locking lever; for flying leads; for tool operation; white	www.wago.com/770-131

Marking accessories

	Item no.: 210-333 Marking strips; as a DIN A4 sheet; Strip width 6 mm; Strip length 182 mm; plain; Self-adhesive; white	www.wago.com/210-333
	Item no.: 770-450 Marker card; Plastic; white	www.wago.com/770-450
	Item no.: 770-450/000-001 Marker card; Plastic; white	www.wago.com/770-450/000-001

Subject to changes. Please also observe the further product documentation!



Item no.: 770-450/000-002
Marker card; Plastic; white

www.wago.com/770-450/000-002



Item no.: 770-450/000-005
Marker card; Plastic; white

www.wago.com/770-450/000-005



Item no.: 770-450/000-006
Marker card; Plastic; white

www.wago.com/770-450/000-006



Item no.: 770-450/000-012
Marker card; Plastic; white

www.wago.com/770-450/000-012

protection



Item no.: 770-201
Lockout cap; 12-pole, separable; 12-pole; for sockets; black

www.wago.com/770-201



Item no.: 770-221
Lockout cap; for socket; 12-pole; separable; white

www.wago.com/770-221

Downloads

Documentation

Bid Text

771-8995/108-801 GAEB X81 - Datei	Feb 19, 2019	xml 3.0 kB	Download
771-8995/108-801 doc - Datei	Mar 16, 2015	doc 26.6 kB	Download

Installation Notes

Product family

<i>WINSTA</i>® MIDI
[Show all products from the family](#)

Subject to changes. Please also observe the further product documentation!