

## Data sheet | Item number: 771-9285/217-201

pre-assembled connecting cable; B2ca; Plug/open-ended; 5-pole; Cod. I;  
H05Z1Z1-F 5G 2.5 mm<sup>2</sup>; 2 m; 2,50 mm<sup>2</sup>; blue

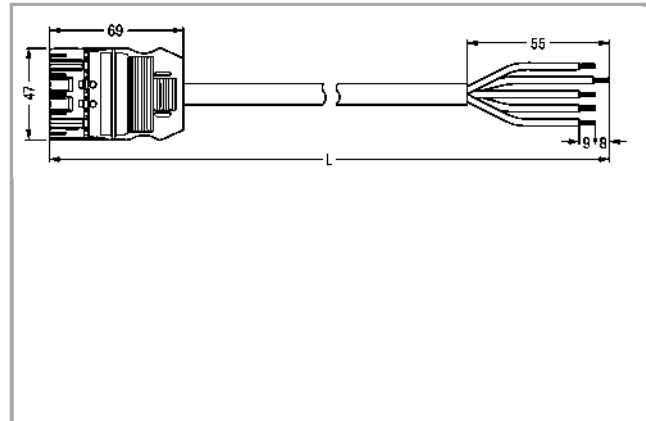

[www.wago.com/771-9285\\_217-201](http://www.wago.com/771-9285_217-201)

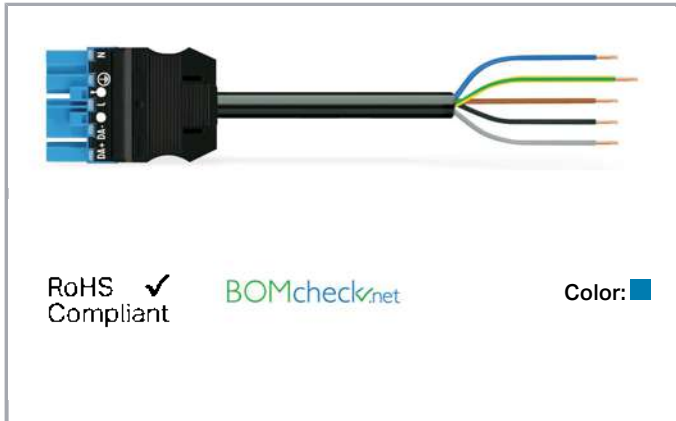

### Item description

- Protected against mismatching and maintenance-free

### Note:

Cables with a different fire class can be found in the eShop.

### Note on mismatching protection:

All WINSTA<sup>®</sup> components are 100% protected against mismatching when:

- plugging different numbers of poles
- plugging while rotated 180
- plugging while laterally staggered
- plugging one pole

### Safety information 1:

Application note for the U.S. market (USR): Some versions may also be used for current interruption in accordance with the UL certificate in select applications with currents below 16 A and voltages up to 600 V. For further information, please contact your local sales office.

## Data

### Electrical data

Note on Contact Resistance

approx. 1 m $\Omega$  of contact resistance approx. 0.25 m $\Omega$  contact transition plug/socket

Subject to changes. Please also observe the further product documentation!

WAGO Kontakttechnik GmbH & Co. KG  
Hansastr. 27  
32423 Minden  
Phone: +49571 887-0 | Fax: +49571 887-169  
Email: [info.de@wago.com](mailto:info.de@wago.com) | Web: [www.wago.com](http://www.wago.com)

Do you have any questions about our products?  
We are always happy to take your call at +49 (571) 887-44222.

## Ratings per IEC/EN 60664-1

Ratings per	IEC/EN 60664-1
Rated voltage (III / 3)	400 V
Rated impulse voltage (III / 3)	6 kV
Rated current	20 A
Legend (ratings)	(III / 3) $\hat{=}$ Overvoltage category III / Pollution degree 3

## Approvals per UL 1977

Rated voltage per UL 1977 (factory wiring only)	600 V
Rated current per UL 1977 (factory wiring only)	23 A

## Connection data

No. of poles	5
Total number of potentials	5
Ground function	with preceding ground contact
Conductor preparation	tip-bonded
Cable diameter	11,2 ... 13,9 mm
Cross section of single conductor	2.5 mm <sup>2</sup>
Strip length	55 mm
Connection type	Plug - Free end

## Geometrical Data

Pin spacing	10 mm / 0.394 inch
Total length	2 m

## Mechanical data

Technologie	DALI
Coding	I
Mating force of a plug-in connection	approx. 20 ... 70 N (depending on pole number)
Retention force of a plug-in connection	when locked: > 80N
Unmating force of a plug-in connection	when unlocked: approx. 20 ... 70 N (depending on pole number)
Number of mating cycles	200 (without resistive load) 100 (with resistive load $I_N = 25$ A), tested (4 mm <sup>2</sup> )
Connection type	Plug - Free end
Type of cable assembly	Connecting cable

Subject to changes. Please also observe the further product documentation!



Type of cable	H05Z1Z1-F 5G2.5
Marking	N L DA- DA+
Protection class	IP20
Note on protection class	Only when mated (these compact connectors are not designed for use in open, easily accessible areas).
Potential marking	N L DA- DA+
Application	Lighting management

### Plug connection

Mismating protection	Yes
Locking of plug-in connection	locking lever
Locking lever	retrofitable

### Material Data

Color	blue
Insulating material	Polyamide 66 (PA 66)
Reaction to fire class per EN 50575	B <sub>2</sub> <sub>ca</sub>
Contact material	Copper or copper alloy (surface-treated)
Connector color	blue
Printing color of mating face	white
Strain relief color	black
Printing color of strain relief	white
Color of sheathed cable	black
Printing color of sheathed cable	white
Halogen-free	Yes
Weight	511.8 g

### Environmental Requirements

Processing temperature	-5 ... +40 °C
Continuous operating temperature	-35 ... +85 °C
Note on Continuous Service Temperature	PVC cable for temperatures ≤ 70 °C (including halogen-free) Insulating parts for temperatures ≤ 105 °C

### Commercial data

Packaging type	not packed
Country of origin	DE
GTIN	4055143659314

Subject to changes. Please also observe the further product documentation!

WAGO Kontakttechnik GmbH & Co. KG  
 Hansastr. 27  
 32423 Minden  
 Phone: +49571 887-0 | Fax: +49571 887-169  
 Email: [info.de@wago.com](mailto:info.de@wago.com) | Web: [www.wago.com](http://www.wago.com)

Do you have any questions about our products?  
 We are always happy to take your call at +49 (571) 887-44222.





Customs Tariff No.

85444290900







## Counterpart

## Compatible products

### Locking lever

	<b>Item no.: 770-101</b> Locking lever; for flying leads; for manual operation; black	<a href="http://www.wago.com/770-101">www.wago.com/770-101</a>
	<b>Item no.: 770-111</b> Locking lever; for flying leads; for tool operation; black	<a href="http://www.wago.com/770-111">www.wago.com/770-111</a>
	<b>Item no.: 770-121</b> Locking lever; for flying leads; for manual operation; white	<a href="http://www.wago.com/770-121">www.wago.com/770-121</a>
	<b>Item no.: 770-131</b> Locking lever; for flying leads; for tool operation; white	<a href="http://www.wago.com/770-131">www.wago.com/770-131</a>

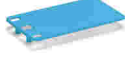
### Marking accessories

	<b>Item no.: 210-334</b> Marking strips; as a DIN A4 sheet; Strip width 5 mm; Strip length 182 mm; plain; Self-adhesive; white	<a href="http://www.wago.com/210-334">www.wago.com/210-334</a>
	<b>Item no.: 770-450</b> Marker card; Plastic; white	<a href="http://www.wago.com/770-450">www.wago.com/770-450</a>
	<b>Item no.: 770-450/000-001</b> Marker card; Plastic; white	<a href="http://www.wago.com/770-450/000-001">www.wago.com/770-450/000-001</a>
	<b>Item no.: 770-450/000-002</b> Marker card; Plastic; white	<a href="http://www.wago.com/770-450/000-002">www.wago.com/770-450/000-002</a>
	<b>Item no.: 770-450/000-005</b> Marker card; Plastic; white	<a href="http://www.wago.com/770-450/000-005">www.wago.com/770-450/000-005</a>
	<b>Item no.: 770-450/000-006</b> Marker card; Plastic; white	<a href="http://www.wago.com/770-450/000-006">www.wago.com/770-450/000-006</a>
	<b>Item no.: 770-450/000-012</b> Marker card; Plastic; white	<a href="http://www.wago.com/770-450/000-012">www.wago.com/770-450/000-012</a>

Subject to changes. Please also observe the further product documentation!



## Downloads

### Documentation

#### Bid Text

771-9285/217-201 GAEB X81 - Datei	Feb 19, 2019	xml 3.1 kB	Download
771-9285/217-201 doc - Datei	Dec 1, 2017	doc 27.1 kB	Download

## Installation Notes

### Product family

<i>WINSTA</i>® MIDI

[Show all products from the family](#)

Subject to changes. Please also observe the further product documentation!

WAGO Kontakttechnik GmbH & Co. KG

Hansastr. 27

32423 Minden

Phone: +49571 887-0 | Fax: +49571 887-169

Email: [info.de@wago.com](mailto:info.de@wago.com) | Web: [www.wago.com](http://www.wago.com)

Do you have any questions about our products?

We are always happy to take your call at +49 (571) 887-44222.