

## Data sheet | Item number: 771-9975/206-702

pre-assembled connecting cable; Eca; Plug/open-ended; 5-pole; Cod. P;  
H05VV-F 5G 1.5 mm<sup>2</sup>; 7 m; 1,50 mm<sup>2</sup>; red

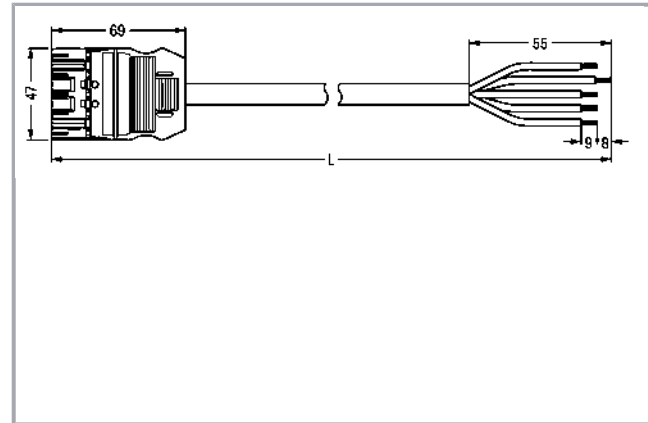

[www.wago.com/771-9975\\_206-702](http://www.wago.com/771-9975_206-702)

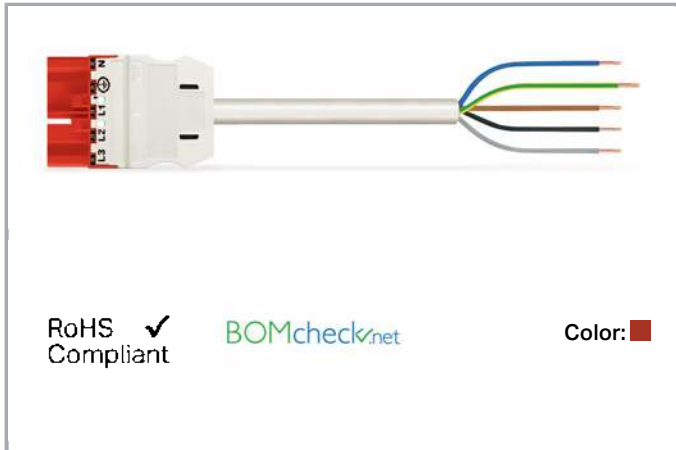

### Item description

- Protected against mismatching and maintenance-free

### Note:

Cables with a different fire class can be found in the eShop.

### Note on mismatching protection:

All WINSTA<sup>®</sup> components are 100% protected against mismatching when:

- plugging different numbers of poles
- plugging while rotated 180
- plugging while laterally staggered
- plugging one pole

### Safety information 1:

Application note for the U.S. market (USR): Some versions may also be used for current interruption in accordance with the UL certificate in select applications with currents below 16 A and voltages up to 600 V. For further information, please contact your local sales office.

## Data

### Electrical data

Note on Contact Resistance

approx. 1 mΩ of contact resistance approx. 0.25 mΩ contact transition plug/socket

Subject to changes. Please also observe the further product documentation!

WAGO Kontakttechnik GmbH & Co. KG  
Hansastr. 27  
32423 Minden  
Phone: +49571 887-0 | Fax: +49571 887-169  
Email: [info.de@wago.com](mailto:info.de@wago.com) | Web: [www.wago.com](http://www.wago.com)

Do you have any questions about our products?  
We are always happy to take your call at +49 (571) 887-44222.



### Ratings per IEC/EN 60664-1

Ratings per	IEC/EN 60664-1
Rated voltage (III / 3)	400 V
Rated impulse voltage (III / 3)	6 kV
Rated current	16 A
Legend (ratings)	(III / 3) ≙ Overvoltage category III / Pollution degree 3

### Approvals per UL 1977

Rated voltage per UL 1977 (factory wiring only)	600 V
Rated current per UL 1977 (factory wiring only)	23 A

### Connection data

Strip length	9 mm / 0.35 inch
No. of poles	5
Total number of potentials	5
Ground function	with preceding ground contact
Conductor preparation	tip-bonded
Cable diameter	9,3 ... 11,6 mm
Cross section of single conductor	1.5 mm <sup>2</sup>
Strip length	55 mm
Connection type	Plug - Free end

### Geometrical Data

Pin spacing	10 mm / 0.394 inch
Total length	7 m

### Mechanical data

Coding	P
Mating force of a plug-in connection	approx. 20 ... 70 N (depending on pole number)
Retention force of a plug-in connection	when locked: > 80N
Unmating force of a plug-in connection	when unlocked: approx. 20 ... 70 N (depending on pole number)
Number of mating cycles	200 (without resistive load) 100 (with resistive load $I_N = 25$ A), tested (4 mm <sup>2</sup> )
Connection type	Plug - free end
Type of cable assembly	Connecting cable
Type of cable	H05VV-F 5G1.5

Subject to changes. Please also observe the further product documentation!



Marking	N L1 L2 L3
Protection class	IP20
Note on protection class	Only when mated (these compact connectors are not designed for use in open, easily accessible areas).
Potential marking	N L1 L2 L3
Application	Computer applications (UPS)

### Plug connection

Mismating protection	Yes
Locking of plug-in connection	locking lever
Locking lever	retrofitable

### Material Data

Color	red
Insulating material	Polyamide 66 (PA 66)
Reaction to fire class per EN 50575	E <sub>ca</sub>
Contact material	Copper or copper alloy (surface-treated)
Connector color	red
Printing color of mating face	black
Strain relief color	white
Printing color of strain relief	black
Color of sheathed cable	white
Printing color of sheathed cable	black
Sheath material	PVC
Weight	1104.2 g

### Environmental Requirements

Processing temperature	-5 ... +40 °C
Continuous operating temperature	-35 ... +85 °C
Note on Continuous Service Temperature	PVC cable for temperatures ≤ 70 °C (including halogen-free) Insulating parts for temperatures ≤ 105 °C

### Commercial data

Packaging type	not packed
Country of origin	DE
GTIN	4055143415996
Customs Tariff No.	85444290900



Subject to changes. Please also observe the further product documentation!

WAGO Kontakttechnik GmbH & Co. KG  
 Hansastr. 27  
 32423 Minden  
 Phone: +49571 887-0 | Fax: +49571 887-169  
 Email: [info.de@wago.com](mailto:info.de@wago.com) | Web: [www.wago.com](http://www.wago.com)

Do you have any questions about our products?  
 We are always happy to take your call at +49 (571) 887-44222.

## Approvals / Certificates





### Country specific Approvals

Logo	Approval	Additional Approval Text	Certificate name
	CCA DEKRA Certification B.V.	EN 61535	NTR NL-7355
	KEMA/KEUR DEKRA Certification B.V.	EN 61535	2179129.01

### Counterpart

### Compatible products

#### Locking lever

	<b>Item no.: 770-101</b> Locking lever; for flying leads; for manual operation; black	<a href="http://www.wago.com/770-101">www.wago.com/770-101</a>
	<b>Item no.: 770-111</b> Locking lever; for flying leads; for tool operation; black	<a href="http://www.wago.com/770-111">www.wago.com/770-111</a>
	<b>Item no.: 770-121</b> Locking lever; for flying leads; for manual operation; white	<a href="http://www.wago.com/770-121">www.wago.com/770-121</a>
	<b>Item no.: 770-131</b> Locking lever; for flying leads; for tool operation; white	<a href="http://www.wago.com/770-131">www.wago.com/770-131</a>

#### protection

	<b>Item no.: 770-360</b> Lockout cap; for plugs; 5-pole; separable; yellow	<a href="http://www.wago.com/770-360">www.wago.com/770-360</a>
--	---	--

#### Marking accessories

	<b>Item no.: 210-334</b> Marking strips; as a DIN A4 sheet; Strip width 5 mm; Strip length 182 mm; plain; Self-adhesive; white	<a href="http://www.wago.com/210-334">www.wago.com/210-334</a>
	<b>Item no.: 770-450</b> Marker card; Plastic; white	<a href="http://www.wago.com/770-450">www.wago.com/770-450</a>

Subject to changes. Please also observe the further product documentation!



Item no.: 770-450/000-001  
Marker card; Plastic; white

[www.wago.com/770-450/000-001](http://www.wago.com/770-450/000-001)



Item no.: 770-450/000-002  
Marker card; Plastic; white

[www.wago.com/770-450/000-002](http://www.wago.com/770-450/000-002)



Item no.: 770-450/000-005  
Marker card; Plastic; white

[www.wago.com/770-450/000-005](http://www.wago.com/770-450/000-005)

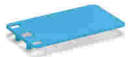

Item no.: 770-450/000-006  
Marker card; Plastic; white

[www.wago.com/770-450/000-006](http://www.wago.com/770-450/000-006)



Item no.: 770-450/000-012  
Marker card; Plastic; white

[www.wago.com/770-450/000-012](http://www.wago.com/770-450/000-012)

## Downloads

### Documentation

#### Bid Text

771-9975/206-702 GAEB X81 - Datei	Feb 19, 2019	xml 3.0 kB	Download
771-9975/206-702 doc - Datei	Dec 11, 2014	doc 27.1 kB	Download

### CAD/CAE-Data

#### CAE data

WSCAD Universe 771-9975/206-702	URL	Download
---------------------------------	-----	----------

## Installation Notes

### Product family

[\*WINSTA\*® MIDI](#)  
[Show all products from the family](#)

Subject to changes. Please also observe the further product documentation!