

Data sheet | Item number: 771-9993/3217-701

pre-assembled connecting cable; Eca; Plug/open-ended; 3-pole; Cod. A;
H05Z1Z1-F 3G 2.5 mm²; 7 m; 2,50 mm²; black

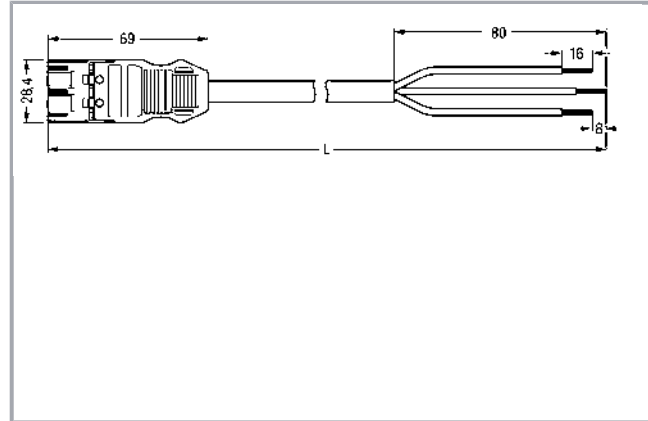

www.wago.com/771-9993_3217-701

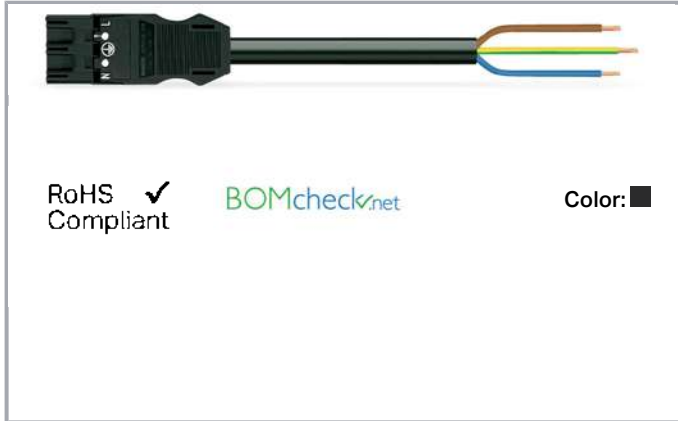

Item description

- Protected against mismatching and maintenance-free
- Additional variable coding is possible

Note:

Cables with a different fire class can be found in the eShop.

Note on mismatching protection:

All WINSTA[®] components are 100% protected against mismatching when:

- plugging different numbers of poles
- plugging while rotated 180
- plugging while laterally staggered
- plugging one pole

Safety information 1:

Application note for the U.S. market (USR): Some versions may also be used for current interruption in accordance with the UL certificate in select applications with currents below 16 A and voltages up to 600 V. For further information, please contact your local sales office.

Data

Electrical data

Note on Contact Resistance

approx. 1 mΩ of contact resistance approx. 0.25 mΩ contact transition plug/socket

Subject to changes. Please also observe the further product documentation!

WAGO Kontakttechnik GmbH & Co. KG
Hansastr. 27
32423 Minden
Phone: +49571 887-0 | Fax: +49571 887-169
Email: info.de@wago.com | Web: www.wago.com

Do you have any questions about our products?
We are always happy to take your call at +49 (571) 887-44222.



Ratings per IEC/EN 60664-1

Ratings per	IEC/EN 60664-1
Rated voltage (III / 3)	250 V
Rated impulse voltage (III / 3)	4 kV
Rated current	20 A
Legend (ratings)	(III / 3) ≙ Overvoltage category III / Pollution degree 3

Approvals per UL 1977

Rated voltage per UL 1977 (factory wiring only)	600 V
Rated current per UL 1977 (factory wiring only)	23 A

Connection data

No. of poles	3
Total number of potentials	3
Ground function	with preceding ground contact
Conductor preparation	tip-bonded
Cable diameter	9,2 ... 11,4 mm
Cross section of single conductor	2.5 mm ²
Strip length	80 mm

Geometrical Data

Pin spacing	10 mm / 0.394 inch
Total length	7 m

Mechanical data

Coding	A
Mating force of a plug-in connection	approx. 20 ... 70 N (depending on pole number)
Retention force of a plug-in connection	when locked: > 80N
Unmating force of a plug-in connection	when unlocked: approx. 20 ... 70 N (depending on pole number)
Number of mating cycles	200 (without resistive load) 100 (with resistive load $I_N = 25$ A), tested (4 mm ²)
Type of cable assembly	Connecting cable
Type of cable	H05Z1Z1-F 3G2.5
Marking	L N
Protection class	IP20
Note on protection class	Only when mated (these compact connectors are not designed for

Subject to changes. Please also observe the further product documentation!



	use in open, easily accessible areas).
Potential marking	L N
Application	for switches and outlet installation
Suitable	for installation of switches and outlets

Plug connection

Mismating protection	Yes
Locking of plug-in connection	locking lever
Locking lever	retrofitable

Material Data

Color	black
Insulating material	Polyamide 66 (PA 66)
Reaction to fire class per EN 50575	E _{ca}
Contact material	Copper or copper alloy (surface-treated)
Fire load	16.257 MJ
Connector color	black
Printing color of mating face	white
Strain relief color	black
Printing color of strain relief	white
Color of sheathed cable	black
Printing color of sheathed cable	white
Halogen-free	Yes
Weight	1045.8 g

Environmental Requirements

Processing temperature	-5 ... +40 °C
Continuous operating temperature	-35 ... +85 °C
Note on Continuous Service Temperature	PVC cable for temperatures ≤ 70 °C (including halogen-free) Insulating parts for temperatures ≤ 105 °C

Commercial data

Packaging type	not packed
Country of origin	DE
GTIN	4045454918293
Customs Tariff No.	85444290900



Subject to changes. Please also observe the further product documentation!

WAGO Kontakttechnik GmbH & Co. KG
Hansastr. 27
32423 Minden
Phone: +49571 887-0 | Fax: +49571 887-169
Email: info.de@wago.com | Web: www.wago.com

Do you have any questions about our products?
We are always happy to take your call at +49 (571) 887-44222.

Approvals / Certificates





Country specific Approvals

Logo	Approval	Additional Approval Text	Certificate name
	CCA DEKRA Certification B.V.	EN 61535	NTR NL-7355
	KEMA/KEUR DEKRA Certification B.V.	EN 61535	2179129.01



Counterpart

Compatible products

Locking lever

	Item no.: 770-101 Locking lever; for flying leads; for manual operation; black	www.wago.com/770-101
	Item no.: 770-111 Locking lever; for flying leads; for tool operation; black	www.wago.com/770-111
	Item no.: 770-121 Locking lever; for flying leads; for manual operation; white	www.wago.com/770-121
	Item no.: 770-131 Locking lever; for flying leads; for tool operation; white	www.wago.com/770-131

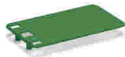
Marking accessories

	Item no.: 210-334 Marking strips; as a DIN A4 sheet; Strip width 5 mm; Strip length 182 mm; plain; Self-adhesive; white	www.wago.com/210-334
	Item no.: 770-450 Marker card; Plastic; white	www.wago.com/770-450
	Item no.: 770-450/000-001 Marker card; Plastic; white	www.wago.com/770-450/000-001
	Item no.: 770-450/000-002 Marker card; Plastic; white	www.wago.com/770-450/000-002

Subject to changes. Please also observe the further product documentation!



Item no.: 770-450/000-005
Marker card; Plastic; white

www.wago.com/770-450/000-005



Item no.: 770-450/000-006
Marker card; Plastic; white

www.wago.com/770-450/000-006



Item no.: 770-450/000-012
Marker card; Plastic; white

www.wago.com/770-450/000-012

Downloads

Documentation

Bid Text

771-9993/3217-701 GAEB X81 - Datei	Feb 19, 2019	xml 3.2 kB	Download
771-9993/3217-701 doc - Datei	Dec 5, 2014	doc 26.6 kB	Download

CAD/CAE-Data

CAE data

WSCAD Universe 771-9993/3217-701	URL	Download
----------------------------------	-----	----------

Installation Notes

Product family

<i>WINSTA</i>® MIDI
[Show all products from the family](#)

Subject to changes. Please also observe the further product documentation!

WAGO Kontakttechnik GmbH & Co. KG
Hansastr. 27
32423 Minden
Phone: +49571 887-0 | Fax: +49571 887-169
Email: info.de@wago.com | Web: www.wago.com

Do you have any questions about our products?
We are always happy to take your call at +49 (571) 887-44222.