

Data sheet | Item number: 788-103

Relay socket; 2 changeover contacts; for 25 mm basic relays; gray

www.wago.com/788-103

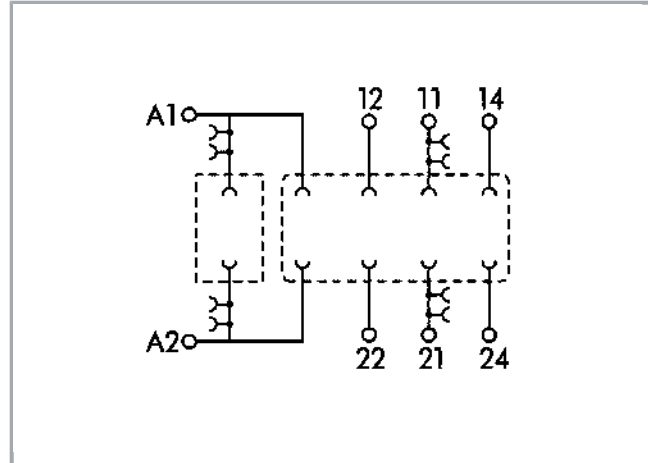
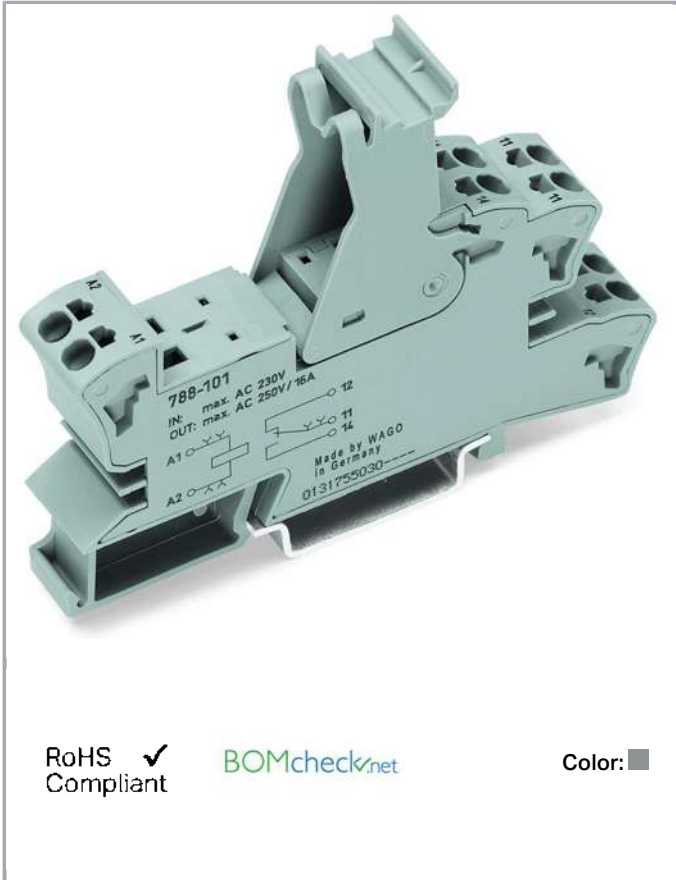

Subject to changes. Please also observe the further product documentation!

WAGO Kontakttechnik GmbH & Co. KG
Hansastr. 27
32423 Minden
Phone: +49571 887-0 | Fax: +49571 887-169
Email: info.de@wago.com | Web: www.wago.com

Do you have any questions about our products?
We are always happy to take your call at +49 (571) 887-44222.

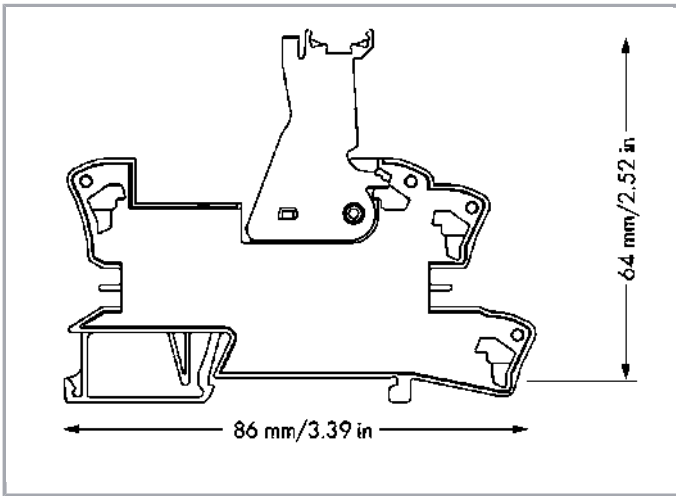

Data

Technical Data

Control circuit

Nominal input voltage U_N	AC/DC 250 V (depending on relay)
Input voltage range	AC/DC 0 ... 250 V
Nominal input current at U_N	0

Load circuit:

Number of changeover/switchover contacts	2
Limiting continuous current	8 A
Max. switching voltage	AC 250 V
Max. switching power (resistive)	AC 2000 VA

Safety and protection:

Rated voltage	250 V
Rated impulse voltage	4 kV
Pollution degree	3
Dielectric strength, control/load circuit (AC, 1 min)	6 kVrms (depending on relay)
Dielectric strength open contact (AC, 1 min)	1 kVrms (depending on relay)
Dielectric strength, channel/channel (AC, 1 min)	(depending on relay)
Dielectric strength, load/load circuit (AC, 1 min)	3.5 kVrms (depending on relay)
Protection class	IP20

Subject to changes. Please also observe the further product documentation!

WAGO Kontakttechnik GmbH & Co. KG
 Hansastr. 27
 32423 Minden
 Phone: +49571 887-0 | Fax: +49571 887-169
 Email: info.de@wago.com | Web: www.wago.com

Do you have any questions about our products?
 We are always happy to take your call at +49 (571) 887-44222.



Connection data

Connection technology	Push-in CAGE CLAMP®
Solid conductor	0.34 ... 2.5 mm ² / 22 ... 14 AWG
Fine-stranded conductor	0.34 ... 2.5 mm ² / 22 ... 14 AWG
Strip length	9 ... 10 mm / 0.35 ... 0.39 inch

Geometrical Data

Width	25 mm / 0.984 inch
Height from upper-edge of DIN-35 rail	64 mm / 2.52 inch
Depth	86 mm / 3.386 inch

Mechanical data

Type of mounting	DIN-35 rail
------------------	-------------

Material Data

Color	gray
Fire load	0.651 MJ
Weight	31 g

Environmental Requirements

Surrounding air (operating) temperature at U _N	-40 ... 70 °C (depending on relay)
Surrounding air (storage) temperature	-40 ... 80 °C
Processing temperature	-25 ... +50 °C

Standards and specifications

Standards/specifications	EN 60664-1
--------------------------	------------

Commercial data

Product Group	6 (Interface Electronics)
Packaging type	BOX
Country of origin	CN
GTIN	4050821591801
Customs Tariff No.	85366990990

Subject to changes. Please also observe the further product documentation!













WAGO Kontakttechnik GmbH & Co. KG
 Hansastr. 27
 32423 Minden
 Phone: +49571 887-0 | Fax: +49571 887-169
 Email: info.de@wago.com | Web: www.wago.com

Do you have any questions about our products?
 We are always happy to take your call at +49 (571) 887-44222.















Counterpart

Compatible products

Jumper

	Item no.: 788-113 Comb-style jumper bar; 2-way; insulated	www.wago.com/788-113
	Item no.: 788-114 Comb-style jumper bar; 3-way; insulated	www.wago.com/788-114
	Item no.: 788-115 Comb-style jumper bar; 4-way; insulated	www.wago.com/788-115
	Item no.: 788-116 Comb-style jumper bar; 6-way; insulated	www.wago.com/788-116
	Item no.: 788-117 Comb-style jumper bar; 8-way; insulated	www.wago.com/788-117
	Item no.: 788-118 Comb-style jumper bar; 2-way (1-3); insulated	www.wago.com/788-118
	Item no.: 859-402 Push-in type jumper bar; 2-way; Nominal current 18 A; insulated; light gray	www.wago.com/859-402
	Item no.: 859-402/000-005 Push-in type jumper bar; 2-way; Nominal current 18 A; insulated; red	www.wago.com/859-402/000-005
	Item no.: 859-402/000-006 Push-in type jumper bar; 2-way; Nominal current 18 A; insulated; blue	www.wago.com/859-402/000-006
	Item no.: 859-402/000-029 Push-in type jumper bar; 2-way; Nominal current 18 A; insulated; yellow	www.wago.com/859-402/000-029
tools		
	Item no.: 210-720 Operating tool; Blade: 3.5 x 0.5 mm; with a partially insulated shaft	www.wago.com/210-720
Marking accessories		
	Item no.: 2009-110 Marking strips; on reel; not stretchable; plain; snap-on type; white	www.wago.com/2009-110

Subject to changes. Please also observe the further product documentation!

	Item no.: 2009-115 WMB-Inline; for Smart Printer; 1500 pieces on roll; stretchable 5 - 5.2 mm; plain; snap-on type; white	www.wago.com/2009-115
	Item no.: 2009-115/000-002 WMB-Inline; for Smart Printer; 1500 pieces on roll; stretchable 5 - 5.2 mm; plain; snap-on type; yellow	www.wago.com/2009-115/000-002
	Item no.: 2009-115/000-006 WMB-Inline; for Smart Printer; 1500 pieces on roll; stretchable 5 - 5.2 mm; plain; snap-on type; white	www.wago.com/2009-115/000-006
	Item no.: 2009-115/000-007 WMB-Inline; for Smart Printer; 1500 pieces on roll; stretchable 5 - 5.2 mm; plain; snap-on type; gray	www.wago.com/2009-115/000-007
	Item no.: 2009-115/000-012 WMB-Inline; for Smart Printer; 1500 pieces on roll; stretchable 5 - 5.2 mm; plain; snap-on type; white	www.wago.com/2009-115/000-012
	Item no.: 2009-115/000-017 WMB-Inline; for Smart Printer; 1500 pieces on roll; stretchable 5 - 5.2 mm; plain; snap-on type; white	www.wago.com/2009-115/000-017
	Item no.: 2009-115/000-023 WMB-Inline; for Smart Printer; 1500 pieces on roll; stretchable 5 - 5.2 mm; plain; snap-on type; green	www.wago.com/2009-115/000-023
	Item no.: 209-128 Adaptor; gray	www.wago.com/209-128
	Item no.: 209-183 Marker card; white	www.wago.com/209-183
	Item no.: 210-110 Fiber-tip pen	www.wago.com/210-110
	Item no.: 249-105 Group marker carrier; gray	www.wago.com/249-105
	Item no.: 793-501 WMB marking card; as card; not stretchable; plain; snap-on type; white	www.wago.com/793-501
	Item no.: 793-501/000-002 WMB marking card; as card; not stretchable; plain; snap-on type; yellow	www.wago.com/793-501/000-002
	Item no.: 793-501/000-005 WMB marking card; as card; not stretchable; plain; snap-on type; red	www.wago.com/793-501/000-005
	Item no.: 793-501/000-006 WMB marking card; as card; not stretchable; plain; snap-on type; blue	www.wago.com/793-501/000-006

Subject to changes. Please also observe the further product documentation!



Item no.: 793-501/000-007
WMB marking card; as card; not stretchable; plain; snap-on type; gray

www.wago.com/793-501/000-007



Item no.: 793-501/000-012
WMB marking card; as card; not stretchable; plain; snap-on type; orange

www.wago.com/793-501/000-012



Item no.: 793-501/000-017
WMB marking card; as card; not stretchable; plain; snap-on type; light green

www.wago.com/793-501/000-017



Item no.: 793-501/000-023
WMB marking card; as card; not stretchable; plain; snap-on type; green

www.wago.com/793-501/000-023



Item no.: 793-501/000-024
WMB marking card; as card; not stretchable; plain; snap-on type; violet

www.wago.com/793-501/000-024



Item no.: 793-502
WMB marking card; as card; MARKED; 1 ... 10 (10x); not stretchable; Horizontal marking; snap-on type; white

www.wago.com/793-502



Item no.: 793-502/000-002
WMB marking card; as card; MARKED; 1 ... 10 (10x); not stretchable; Horizontal marking; snap-on type; yellow

www.wago.com/793-502/000-002



Item no.: 793-502/000-005
WMB marking card; as card; MARKED; 1 ... 10 (10x); not stretchable; Horizontal marking; snap-on type; red

www.wago.com/793-502/000-005



Item no.: 793-502/000-006
WMB marking card; as card; MARKED; 1 ... 10 (10x); not stretchable; Horizontal marking; snap-on type; blue

www.wago.com/793-502/000-006



Item no.: 793-502/000-007
WMB marking card; as card; MARKED; 1 ... 10 (10x); not stretchable; Horizontal marking; snap-on type; gray

www.wago.com/793-502/000-007



Item no.: 793-502/000-012
WMB marking card; as card; MARKED; 1 ... 10 (10x); not stretchable; Horizontal marking; snap-on type; orange

www.wago.com/793-502/000-012



Item no.: 793-502/000-017
WMB marking card; as card; MARKED; 1 ... 10 (10x); not stretchable; Horizontal marking; snap-on type; light green

www.wago.com/793-502/000-017



Item no.: 793-502/000-023
WMB marking card; as card; MARKED; 1 ... 10 (10x); not stretchable; Horizontal marking; snap-on type; green

www.wago.com/793-502/000-023

Item no.: 793-502/000-024
WMB marking card; as card; MARKED; 1 ... 10 (10x); not stretchable; Horizontal marking; snap-on type;

Subject to changes. Please also observe the further product documentation!



violet

www.wago.com/793-502/000-024
**Item no.: 793-503**WMB marking card; as card; MARKED; 11 ... 20 (10x); not stretchable; Horizontal marking; snap-on type; www.wago.com/793-503
white**Item no.: 793-503/000-002**WMB marking card; as card; MARKED; 11 ... 20 (10x); not stretchable; Horizontal marking; snap-on type; www.wago.com/793-503/000-002
yellow**Item no.: 793-503/000-005**WMB marking card; as card; MARKED; 11 ... 20 (10x); not stretchable; Horizontal marking; snap-on type; www.wago.com/793-503/000-005
red**Item no.: 793-503/000-006**WMB marking card; as card; MARKED; 11 ... 20 (10x); not stretchable; Horizontal marking; snap-on type; www.wago.com/793-503/000-006
blue**Item no.: 793-503/000-007**WMB marking card; as card; MARKED; 11 ... 20 (10x); not stretchable; Horizontal marking; snap-on type; www.wago.com/793-503/000-007
gray**Item no.: 793-503/000-012**WMB marking card; as card; MARKED; 11 ... 20 (10x); not stretchable; Horizontal marking; snap-on type; www.wago.com/793-503/000-012
orange**Item no.: 793-503/000-017**WMB marking card; as card; MARKED; 11 ... 20 (10x); not stretchable; Horizontal marking; snap-on type; www.wago.com/793-503/000-017
light green**Item no.: 793-503/000-023**WMB marking card; as card; MARKED; 11 ... 20 (10x); not stretchable; Horizontal marking; snap-on type; www.wago.com/793-503/000-023
green**Item no.: 793-503/000-024**WMB marking card; as card; MARKED; 11 ... 20 (10x); not stretchable; Horizontal marking; snap-on type; www.wago.com/793-503/000-024
violet**Item no.: 793-504**WMB marking card; as card; MARKED; 21 ... 30 (10x); not stretchable; Horizontal marking; snap-on type; www.wago.com/793-504
white**Item no.: 793-504/000-002**WMB marking card; as card; MARKED; 21 ... 30 (10x); not stretchable; Horizontal marking; snap-on type; www.wago.com/793-504/000-002
yellow**Item no.: 793-504/000-005**WMB marking card; as card; MARKED; 21 ... 30 (10x); not stretchable; Horizontal marking; snap-on type; www.wago.com/793-504/000-005
red**Item no.: 793-504/000-006**

WMB marking card; as card; MARKED; 21 ... 30 (10x); not stretchable; Horizontal marking; snap-on type;

Subject to changes. Please also observe the further product documentation!

WAGO Kontakttechnik GmbH & Co. KG

Hansastr. 27













32423 Minden

Phone: +49571 887-0 | Fax: +49571 887-169

Email: info.de@wago.com | Web: www.wago.com

Do you have any questions about our products?

We are always happy to take your call at +49 (571) 887-44222.

	blue	www.wago.com/793-504/000-006
	Item no.: 793-504/000-012 WMB marking card; as card; MARKED; 21 ... 30 (10x); not stretchable; Horizontal marking; snap-on type; orange	www.wago.com/793-504/000-012
	Item no.: 793-504/000-017 WMB marking card; as card; MARKED; 21 ... 30 (10x); not stretchable; Horizontal marking; snap-on type; light green	www.wago.com/793-504/000-017
	Item no.: 793-504/000-023 WMB marking card; as card; MARKED; 21 ... 30 (10x); not stretchable; Horizontal marking; snap-on type; green	www.wago.com/793-504/000-023
	Item no.: 793-505 WMB marking card; as card; MARKED; 31 ... 40 (10x); not stretchable; Horizontal marking; snap-on type; white	www.wago.com/793-505
	Item no.: 793-505/000-005 WMB marking card; as card; MARKED; 31 ... 40 (10x); not stretchable; Horizontal marking; snap-on type; red	www.wago.com/793-505/000-005
	Item no.: 793-505/000-006 WMB marking card; as card; MARKED; 31 ... 40 (10x); not stretchable; Horizontal marking; snap-on type; blue	www.wago.com/793-505/000-006
	Item no.: 793-505/000-007 WMB marking card; as card; MARKED; 31 ... 40 (10x); not stretchable; Horizontal marking; snap-on type; gray	www.wago.com/793-505/000-007
	Item no.: 793-505/000-012 WMB marking card; as card; MARKED; 31 ... 40 (10x); not stretchable; Horizontal marking; snap-on type; orange	www.wago.com/793-505/000-012
	Item no.: 793-506 WMB marking card; as card; MARKED; 41 ... 50 (10x); not stretchable; Horizontal marking; snap-on type; white	www.wago.com/793-506
	Item no.: 793-506/000-005 WMB marking card; as card; MARKED; 41 ... 50 (10x); not stretchable; Horizontal marking; snap-on type; red	www.wago.com/793-506/000-005
	Item no.: 793-506/000-006 WMB marking card; as card; MARKED; 41 ... 50 (10x); not stretchable; Horizontal marking; snap-on type; blue	www.wago.com/793-506/000-006
	Item no.: 793-506/000-012 WMB marking card; as card; MARKED; 41 ... 50 (10x); not stretchable; Horizontal marking; snap-on type; orange	www.wago.com/793-506/000-012
	Item no.: 793-506/000-017 WMB marking card; as card; MARKED; 41 ... 50 (10x); not stretchable; Horizontal marking; snap-on type;	

Subject to changes. Please also observe the further product documentation!



light green

www.wago.com/793-506/000-017



Item no.: 793-5501

WMB marking card; as card; for terminal block width 5 - 17.5 mm; stretchable 5 - 5.2 mm; plain; snap-on type; white

www.wago.com/793-5501



Item no.: 793-5501/000-002

WMB marking card; as card; for terminal block width 5 - 17.5 mm; stretchable 5 - 5.2 mm; plain; snap-on type; yellow

www.wago.com/793-5501/000-002



Item no.: 793-5501/000-005

WMB marking card; as card; for terminal block width 5 - 17.5 mm; stretchable 5 - 5.2 mm; plain; snap-on type; red

www.wago.com/793-5501/000-005



Item no.: 793-5501/000-006

WMB marking card; as card; for terminal block width 5 - 17.5 mm; stretchable 5 - 5.2 mm; plain; snap-on type; blue

www.wago.com/793-5501/000-006



Item no.: 793-5501/000-007

WMB marking card; as card; for terminal block width 5 - 17.5 mm; stretchable 5 - 5.2 mm; plain; snap-on type; gray

www.wago.com/793-5501/000-007



Item no.: 793-5501/000-012

WMB marking card; as card; for terminal block width 5 - 17.5 mm; stretchable 5 - 5.2 mm; plain; snap-on type; orange

www.wago.com/793-5501/000-012



Item no.: 793-5501/000-014

WMB marking card; as card; for terminal block width 5 - 17.5 mm; stretchable 5 - 5.2 mm; plain; snap-on type; brown

www.wago.com/793-5501/000-014



Item no.: 793-5501/000-017

WMB marking card; as card; for terminal block width 5 - 17.5 mm; stretchable 5 - 5.2 mm; plain; snap-on type; green

www.wago.com/793-5501/000-017



Item no.: 793-5501/000-023

WMB marking card; as card; for terminal block width 5 - 17.5 mm; stretchable 5 - 5.2 mm; plain; snap-on type; light green

www.wago.com/793-5501/000-023



Item no.: 793-5501/000-024

WMB marking card; as card; for terminal block width 5 - 17.5 mm; stretchable 5 - 5.2 mm; plain; snap-on type; violet

www.wago.com/793-5501/000-024



Item no.: 793-566

WMB marking card; as card; MARKED; 1 ... 50 (2x); not stretchable; Horizontal marking; snap-on type; white

www.wago.com/793-566



Item no.: 793-566/000-002















WMB marking card; as card; MARKED; 1 ... 50 (2x); not stretchable; Horizontal marking; snap-on type; yellow

www.wago.com/793-566/000-002

Item no.: 793-566/000-005

WMB marking card; as card; MARKED; 1 ... 50 (2x); not stretchable; Horizontal marking; snap-on type;

Subject to changes. Please also observe the further product documentation!

	red	www.wago.com/793-566/000-005
	Item no.: 793-566/000-006 WMB marking card; as card; MARKED; 1 ... 50 (2x); not stretchable; Horizontal marking; snap-on type; blue	www.wago.com/793-566/000-006
	Item no.: 793-566/000-007 WMB marking card; as card; MARKED; 1 ... 50 (2x); not stretchable; Horizontal marking; snap-on type; gray	www.wago.com/793-566/000-007
	Item no.: 793-566/000-012 WMB marking card; as card; MARKED; 1 ... 50 (2x); not stretchable; Horizontal marking; snap-on type; orange	www.wago.com/793-566/000-012
	Item no.: 793-566/000-017 WMB marking card; as card; MARKED; 1 ... 50 (2x); not stretchable; Horizontal marking; snap-on type; light green	www.wago.com/793-566/000-017
	Item no.: 793-566/000-023 WMB marking card; as card; MARKED; 1 ... 50 (2x); not stretchable; Horizontal marking; snap-on type; green	www.wago.com/793-566/000-023
	Item no.: 793-566/000-024 WMB marking card; as card; MARKED; 1 ... 50 (2x); not stretchable; Horizontal marking; snap-on type; violet	www.wago.com/793-566/000-024
General accessories		
	Item no.: 209-145 Group marker carrier; white	www.wago.com/209-145
	Item no.: 209-184 Protection cover; transparent	www.wago.com/209-184
	Item no.: 788-120 Accessories for relay modules; Operation status indicator: red	www.wago.com/788-120
	Item no.: 788-121 Accessories for relay modules; Operation status indicator: red	www.wago.com/788-121
	Item no.: 788-122 Operation status indicator; 110 VDC	www.wago.com/788-122
	Item no.: 788-123 Accessories for relay modules; Operation status indicator: red	www.wago.com/788-123
	Item no.: 788-124 Accessories for relay modules; Operation status indicator: red	www.wago.com/788-124
	Item no.: 788-125 Accessories for relay modules; Operation status indicator: red	www.wago.com/788-125

Subject to changes. Please also observe the further product documentation!

**Item no.: 788-148**

Filter module; RC filter element; Nominal voltage: 230 VAC

www.wago.com/788-148**ferrule****Item no.: 216-241**Ferrule; Sleeve for 0.5 mm² / 20 AWG; insulated; electro-tin plated; electrolytic copper; gastight crimped; acc. to DIN 46228, Part 4/09.90; whitewww.wago.com/216-241**Item no.: 216-242**Ferrule; Sleeve for 0.75 mm² / 18 AWG; insulated; electro-tin plated; electrolytic copper; gastight crimped; acc. to DIN 46228, Part 4/09.90; graywww.wago.com/216-242**Item no.: 216-243**Ferrule; Sleeve for 1 mm² / AWG 18; insulated; electro-tin plated; electrolytic copper; gastight crimped; acc. to DIN 46228, Part 4/09.90; redwww.wago.com/216-243**Item no.: 216-244**Ferrule; Sleeve for 1.5 mm² / AWG 16; insulated; electro-tin plated; electrolytic copper; gastight crimped; acc. to DIN 46228, Part 4/09.90; blackwww.wago.com/216-244**Item no.: 216-542**Twin ferrule; Sleeve for 2 x 1 mm² / AWG 2 x 18; red, insulated; 12 mm long; redwww.wago.com/216-542**Downloads****Documentation****Bid Text**

788-103 GAEB docx - Datei	Feb 20, 2019	docx 16.4 kB	Download
788-103 GAEB X81 - Datei	Feb 19, 2019	xml 3.7 kB	Download

Additional Information

Disposal; Electrical and electronic equipment, Packaging	V 1.0.0	pdf 265.8 kB	Download
--	---------	-----------------	----------

CAD/CAE-Data**CAD data**

2D/3D Models 788-103	URL	Download
----------------------	-----	----------

CAE data

EPLAN Data Portal 788-103	URL	Download
---------------------------	-----	----------

WSCAD Universe 788-103

Subject to changes. Please also observe the further product documentation!

WAGO Kontakttechnik GmbH & Co. KG

Hansastr. 27

32423 Minden

Phone: +49571 887-0 | Fax: +49571 887-169

Email: info.de@wago.com | Web: www.wago.com

Do you have any questions about our products?

We are always happy to take your call at +49 (571) 887-44222.



[URL](#)

[Download](#)

Installation Notes

Subject to changes. Please also observe the further product documentation!

WAGO Kontakttechnik GmbH & Co. KG
Hansastr. 27
32423 Minden
Phone: +49571 887-0 | Fax: +49571 887-169
Email: info.de@wago.com | Web: www.wago.com

Do you have any questions about our products?
We are always happy to take your call at +49 (571) 887-44222.