

**Data sheet | Item number: 788-312**

Relay module; Nominal input voltage: 24 VDC; 2 changeover contacts;  
Limiting continuous current: 8 A; Red status indicator; Module width: 15 mm;  
2,50 mm<sup>2</sup>; gray

[www.wago.com/788-312](http://www.wago.com/788-312)

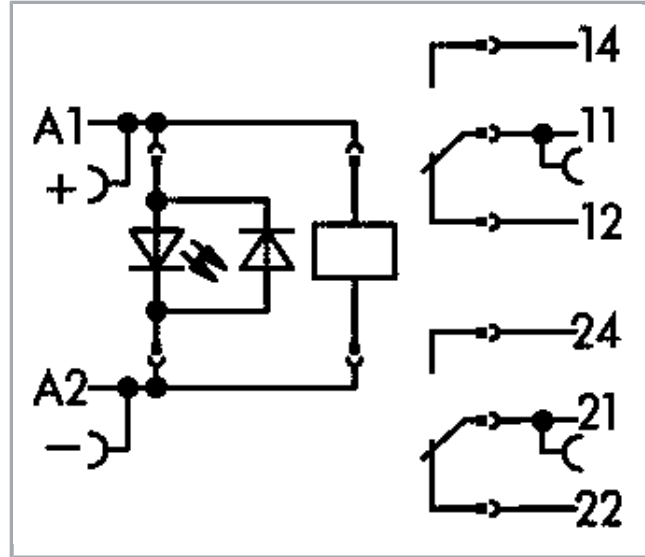
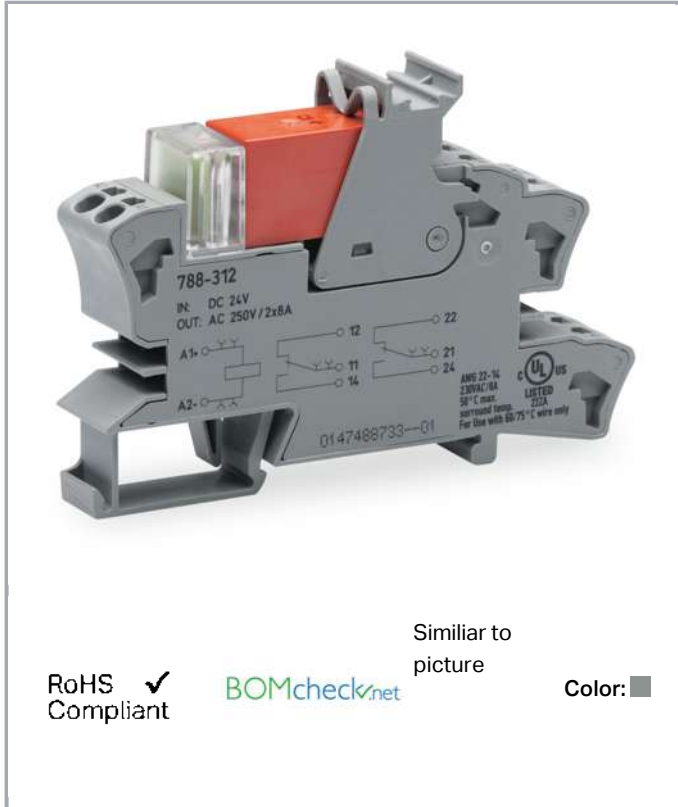

RoHS  Compliant

[BOMcheck.net](https://www.bomcheck.net)

Similar to picture

Color:

Subject to changes. Please also observe the further product documentation!

WAGO Kontakttechnik GmbH & Co. KG  
Hansastr. 27  
32423 Minden  
Phone: +49571 887-0 | Fax: +49571 887-169  
Email: [info.de@wago.com](mailto:info.de@wago.com) | Web: [www.wago.com](http://www.wago.com)

Do you have any questions about our products?  
We are always happy to take your call at +49 (571) 887-44222.

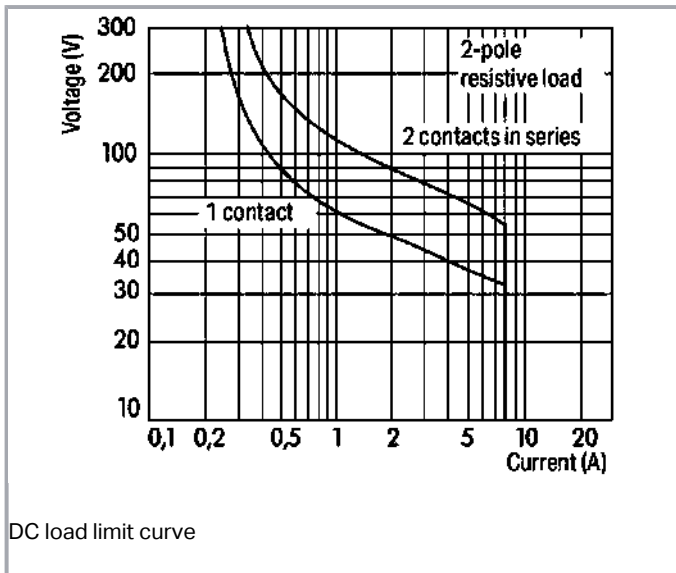
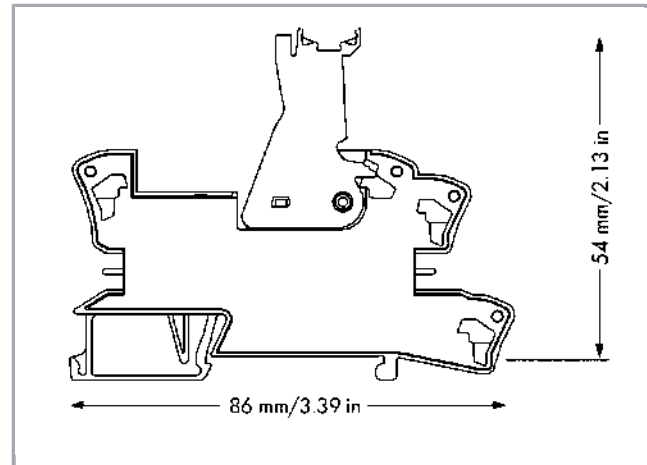
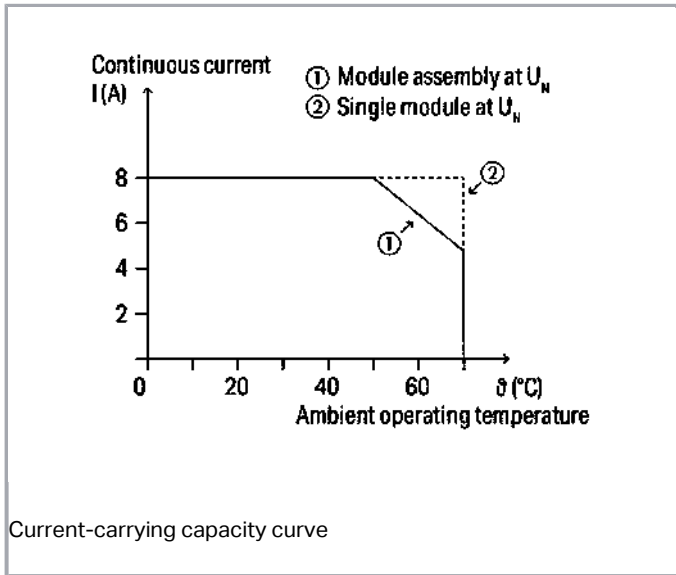

## Item description

### Note:

- Reinforced insulation between coil and contacts
- A separator plate (e.g., 209-191) must be used for voltages greater than 250 V between adjacent relay modules and for compliance with the reinforced insulation requirements.
- To protect the relay coils and contacts, inductive loads must be dampened with an effective protection circuit.

Subject to changes. Please also observe the further product documentation!

**Data****Technical Data****Control circuit**

Nominal input voltage $U_N$	DC 24 V
Input voltage range	$\pm 10\%$
Nominal input current at $U_N$	19 mA

**Load circuit:**

Number of changeover/switchover contacts	2
Contact material (relay)	AgNi 90/10
Limiting continuous current	8 A
Max. make current (resistive)	(AC) 15 A / 4 s
Max. switching voltage	AC 250 V
Max. switching power (resistive)	AC 2000 VA; DC see load limit curve
Switching capacity	AC-15: 3 A / AC 250 V; DC-13: 2 A / DC 24 V
Recommended minimum load	12 V / 10 mA
Pull-in time (typ.)	8 ms
Drop-out time (typ.)	13 ms
Bounce time (typ.)	10 ms
Electrical life (N.O.; resistive load; 23 °C)	$10 \times 10^3$ switching operations
Mechanical life	$30 \times 10^6$ switching operations
Max. switching load with load/without load	$6 \text{ min}^{-1}$ / $1200 \text{ min}^{-1}$

**Signaling**

Status indication	LED red
-------------------	---------

**Safety and protection:**

Rated voltage	250 V
Rated impulse voltage	4 kV
Pollution degree	3
Dielectric strength, control/load circuit (AC, 1 min)	5 kVrms
Dielectric strength open contact (AC, 1 min)	1 kVrms
Dielectric strength, load/load circuit (AC, 1 min)	2.5 kVrms
Protection class	IP20

Subject to changes. Please also observe the further product documentation!



## Connection data

Connection technology	Push-in CAGE CLAMP®
Solid conductor	0.34 ... 2.5 mm <sup>2</sup> / 22 ... 14 AWG
Fine-stranded conductor	0.34 ... 2.5 mm <sup>2</sup> / 22 ... 14 AWG
Strip length	9 ... 10 mm / 0.35 ... 0.39 inch

## Geometrical Data

Width	15 mm / 0.591 inch
Height from upper-edge of DIN-35 rail	54 mm / 2.126 inch
Depth	86 mm / 3.386 inch

## Mechanical data

Type of mounting	DIN-35 rail
------------------	-------------

## Material Data

Color	gray
Fire load	1.349 MJ
Weight	45.5 g

## Environmental Requirements

Surrounding air (operating) temperature at U <sub>N</sub>	-40 ... 70 °C
Surrounding air (storage) temperature	-40 ... 70 °C
Processing temperature	-25 ... +50 °C

## Standards and specifications

Standards/specifications	EN 61010-2-201; EN 61810-1; EN 61373; UL 508
--------------------------	--

## Elementary relay

WAGO elementary relay	788-156
-----------------------	---------

## Commercial data

Product Group	6 (Interface Electronics)
Packaging type	BOX

Subject to changes. Please also observe the further product documentation!

Country of origin	CN
GTIN	4055143184137
Customs Tariff No.	85364900990

## Approvals / Certificates





### UL-Approvals

Logo	Approval	Additional Approval Text	Certificate name
	<b>UL</b> UL International Netherlands B.V. (ORDINARY LOCATIONS)	UL 508	E175199 Sec.6

## Counterpart

## Compatible products



### General accessories

	<b>Item no.: 209-145</b> Group marker carrier; white	<a href="http://www.wago.com/209-145">www.wago.com/209-145</a>
	<b>Item no.: 209-184</b> Protection cover; transparent	<a href="http://www.wago.com/209-184">www.wago.com/209-184</a>
	<b>Item no.: 788-120</b> Accessories for relay modules; Operation status indicator: red	<a href="http://www.wago.com/788-120">www.wago.com/788-120</a>
	<b>Item no.: 788-156</b> Basic relay; Nominal input voltage: 24 VDC; 2 changeover contacts; Limiting continuous current: 8 A; Module width: 13 mm; Module height: 15 mm	<a href="http://www.wago.com/788-156">www.wago.com/788-156</a>









### tools

	<b>Item no.: 210-720</b> Operating tool; Blade: 3.5 x 0.5 mm; with a partially insulated shaft	<a href="http://www.wago.com/210-720">www.wago.com/210-720</a>
--	---	--







### Jumper

	<b>Item no.: 788-113</b> Comb-style jumper bar; 2-way; insulated	<a href="http://www.wago.com/788-113">www.wago.com/788-113</a>
	<b>Item no.: 788-114</b> Comb-style jumper bar; 3-way; insulated	<a href="http://www.wago.com/788-114">www.wago.com/788-114</a>















Subject to changes. Please also observe the further product documentation!

	<b>Item no.: 788-115</b> Comb-style jumper bar; 4-way; insulated	<a href="http://www.wago.com/788-115">www.wago.com/788-115</a>
	<b>Item no.: 788-116</b> Comb-style jumper bar; 6-way; insulated	<a href="http://www.wago.com/788-116">www.wago.com/788-116</a>
	<b>Item no.: 788-117</b> Comb-style jumper bar; 8-way; insulated	<a href="http://www.wago.com/788-117">www.wago.com/788-117</a>
	<b>Item no.: 788-118</b> Comb-style jumper bar; 2-way (1-3); insulated	<a href="http://www.wago.com/788-118">www.wago.com/788-118</a>
	<b>Item no.: 859-402</b> Push-in type jumper bar; 2-way; Nominal current 18 A; insulated; light gray	<a href="http://www.wago.com/859-402">www.wago.com/859-402</a>
	<b>Item no.: 859-402/000-005</b> Push-in type jumper bar; 2-way; Nominal current 18 A; insulated; red	<a href="http://www.wago.com/859-402/000-005">www.wago.com/859-402/000-005</a>
	<b>Item no.: 859-402/000-006</b> Push-in type jumper bar; 2-way; Nominal current 18 A; insulated; blue	<a href="http://www.wago.com/859-402/000-006">www.wago.com/859-402/000-006</a>
	<b>Item no.: 859-402/000-029</b> Push-in type jumper bar; 2-way; Nominal current 18 A; insulated; yellow	<a href="http://www.wago.com/859-402/000-029">www.wago.com/859-402/000-029</a>

**Marking accessories**

	<b>Item no.: 2009-110</b> Marking strips; on reel; not stretchable; plain; snap-on type; white	<a href="http://www.wago.com/2009-110">www.wago.com/2009-110</a>
	<b>Item no.: 2009-115</b> WMB-Inline; for Smart Printer; 1500 pieces on roll; stretchable 5 - 5.2 mm; plain; snap-on type; white	<a href="http://www.wago.com/2009-115">www.wago.com/2009-115</a>
	<b>Item no.: 2009-115/000-002</b> WMB-Inline; for Smart Printer; 1500 pieces on roll; stretchable 5 - 5.2 mm; plain; snap-on type; yellow	<a href="http://www.wago.com/2009-115/000-002">www.wago.com/2009-115/000-002</a>
	<b>Item no.: 2009-115/000-006</b> WMB-Inline; for Smart Printer; 1500 pieces on roll; stretchable 5 - 5.2 mm; plain; snap-on type; white	<a href="http://www.wago.com/2009-115/000-006">www.wago.com/2009-115/000-006</a>
	<b>Item no.: 2009-115/000-007</b> WMB-Inline; for Smart Printer; 1500 pieces on roll; stretchable 5 - 5.2 mm; plain; snap-on type; gray	<a href="http://www.wago.com/2009-115/000-007">www.wago.com/2009-115/000-007</a>
	<b>Item no.: 2009-115/000-012</b> WMB-Inline; for Smart Printer; 1500 pieces on roll; stretchable 5 - 5.2 mm; plain; snap-on type; white	<a href="http://www.wago.com/2009-115/000-012">www.wago.com/2009-115/000-012</a>
	<b>Item no.: 2009-115/000-017</b> WMB-Inline; for Smart Printer; 1500 pieces on roll; stretchable 5 - 5.2 mm; plain; snap-on type; white	<a href="http://www.wago.com/2009-115/000-017">www.wago.com/2009-115/000-017</a>

Subject to changes. Please also observe the further product documentation!

	<b>Item no.: 2009-115/000-023</b> WMB-Inline; for Smart Printer; 1500 pieces on roll; stretchable 5 - 5.2 mm; plain; snap-on type; green	<a href="http://www.wago.com/2009-115/000-023">www.wago.com/2009-115/000-023</a>
	<b>Item no.: 209-128</b> Adaptor; gray	<a href="http://www.wago.com/209-128">www.wago.com/209-128</a>
	<b>Item no.: 209-183</b> Marker card; white	<a href="http://www.wago.com/209-183">www.wago.com/209-183</a>
	<b>Item no.: 210-110</b> Fiber-tip pen	<a href="http://www.wago.com/210-110">www.wago.com/210-110</a>
	<b>Item no.: 249-105</b> Group marker carrier; gray	<a href="http://www.wago.com/249-105">www.wago.com/249-105</a>
	<b>Item no.: 793-501</b> WMB marking card; as card; not stretchable; plain; snap-on type; white	<a href="http://www.wago.com/793-501">www.wago.com/793-501</a>
	<b>Item no.: 793-501/000-002</b> WMB marking card; as card; not stretchable; plain; snap-on type; yellow	<a href="http://www.wago.com/793-501/000-002">www.wago.com/793-501/000-002</a>
	<b>Item no.: 793-501/000-005</b> WMB marking card; as card; not stretchable; plain; snap-on type; red	<a href="http://www.wago.com/793-501/000-005">www.wago.com/793-501/000-005</a>
	<b>Item no.: 793-501/000-006</b> WMB marking card; as card; not stretchable; plain; snap-on type; blue	<a href="http://www.wago.com/793-501/000-006">www.wago.com/793-501/000-006</a>
	<b>Item no.: 793-501/000-007</b> WMB marking card; as card; not stretchable; plain; snap-on type; gray	<a href="http://www.wago.com/793-501/000-007">www.wago.com/793-501/000-007</a>
	<b>Item no.: 793-501/000-012</b> WMB marking card; as card; not stretchable; plain; snap-on type; orange	<a href="http://www.wago.com/793-501/000-012">www.wago.com/793-501/000-012</a>
	<b>Item no.: 793-501/000-017</b> WMB marking card; as card; not stretchable; plain; snap-on type; light green	<a href="http://www.wago.com/793-501/000-017">www.wago.com/793-501/000-017</a>
	<b>Item no.: 793-501/000-023</b> WMB marking card; as card; not stretchable; plain; snap-on type; green	<a href="http://www.wago.com/793-501/000-023">www.wago.com/793-501/000-023</a>
	<b>Item no.: 793-501/000-024</b> WMB marking card; as card; not stretchable; plain; snap-on type; violet	<a href="http://www.wago.com/793-501/000-024">www.wago.com/793-501/000-024</a>
	<b>Item no.: 793-502</b> WMB marking card; as card; MARKED; 1 ... 10 (10x); not stretchable; Horizontal marking; snap-on type; white	<a href="http://www.wago.com/793-502">www.wago.com/793-502</a>

Subject to changes. Please also observe the further product documentation!

**Item no.: 793-502/000-002**

WMB marking card; as card; MARKED; 1 ... 10 (10x); not stretchable; Horizontal marking; snap-on type; yellow

[www.wago.com/793-502/000-002](http://www.wago.com/793-502/000-002)**Item no.: 793-502/000-005**

WMB marking card; as card; MARKED; 1 ... 10 (10x); not stretchable; Horizontal marking; snap-on type; red

[www.wago.com/793-502/000-005](http://www.wago.com/793-502/000-005)**Item no.: 793-502/000-006**

WMB marking card; as card; MARKED; 1 ... 10 (10x); not stretchable; Horizontal marking; snap-on type; blue

[www.wago.com/793-502/000-006](http://www.wago.com/793-502/000-006)**Item no.: 793-502/000-007**

WMB marking card; as card; MARKED; 1 ... 10 (10x); not stretchable; Horizontal marking; snap-on type; gray

[www.wago.com/793-502/000-007](http://www.wago.com/793-502/000-007)**Item no.: 793-502/000-012**

WMB marking card; as card; MARKED; 1 ... 10 (10x); not stretchable; Horizontal marking; snap-on type; orange

[www.wago.com/793-502/000-012](http://www.wago.com/793-502/000-012)**Item no.: 793-502/000-017**

WMB marking card; as card; MARKED; 1 ... 10 (10x); not stretchable; Horizontal marking; snap-on type; light green

[www.wago.com/793-502/000-017](http://www.wago.com/793-502/000-017)**Item no.: 793-502/000-023**

WMB marking card; as card; MARKED; 1 ... 10 (10x); not stretchable; Horizontal marking; snap-on type; green

[www.wago.com/793-502/000-023](http://www.wago.com/793-502/000-023)**Item no.: 793-502/000-024**

WMB marking card; as card; MARKED; 1 ... 10 (10x); not stretchable; Horizontal marking; snap-on type; violet

[www.wago.com/793-502/000-024](http://www.wago.com/793-502/000-024)**Item no.: 793-503**

WMB marking card; as card; MARKED; 11 ... 20 (10x); not stretchable; Horizontal marking; snap-on type; white

[www.wago.com/793-503](http://www.wago.com/793-503)**Item no.: 793-503/000-002**

WMB marking card; as card; MARKED; 11 ... 20 (10x); not stretchable; Horizontal marking; snap-on type; yellow

[www.wago.com/793-503/000-002](http://www.wago.com/793-503/000-002)**Item no.: 793-503/000-005**

WMB marking card; as card; MARKED; 11 ... 20 (10x); not stretchable; Horizontal marking; snap-on type; red

[www.wago.com/793-503/000-005](http://www.wago.com/793-503/000-005)**Item no.: 793-503/000-006**

WMB marking card; as card; MARKED; 11 ... 20 (10x); not stretchable; Horizontal marking; snap-on type; blue

[www.wago.com/793-503/000-006](http://www.wago.com/793-503/000-006)**Item no.: 793-503/000-007**

WMB marking card; as card; MARKED; 11 ... 20 (10x); not stretchable; Horizontal marking; snap-on type; gray

[www.wago.com/793-503/000-007](http://www.wago.com/793-503/000-007)**Item no.: 793-503/000-012**

Subject to changes. Please also observe the further product documentation!

WAGO Kontakttechnik GmbH &amp; Co. KG

Hansastr. 27

32423 Minden













Phone: +49571 887-0 | Fax: +49571 887-169

Email: [info.de@wago.com](mailto:info.de@wago.com) | Web: [www.wago.com](http://www.wago.com)

Do you have any questions about our products?

We are always happy to take your call at +49 (571) 887-44222.



	WMB marking card; as card; MARKED; 11 ... 20 (10x); not stretchable; Horizontal marking; snap-on type; orange	<a href="http://www.wago.com/793-503/000-012">www.wago.com/793-503/000-012</a>
	<b>Item no.: 793-503/000-017</b> WMB marking card; as card; MARKED; 11 ... 20 (10x); not stretchable; Horizontal marking; snap-on type; light green	<a href="http://www.wago.com/793-503/000-017">www.wago.com/793-503/000-017</a>
	<b>Item no.: 793-503/000-023</b> WMB marking card; as card; MARKED; 11 ... 20 (10x); not stretchable; Horizontal marking; snap-on type; green	<a href="http://www.wago.com/793-503/000-023">www.wago.com/793-503/000-023</a>
	<b>Item no.: 793-503/000-024</b> WMB marking card; as card; MARKED; 11 ... 20 (10x); not stretchable; Horizontal marking; snap-on type; violet	<a href="http://www.wago.com/793-503/000-024">www.wago.com/793-503/000-024</a>
	<b>Item no.: 793-504</b> WMB marking card; as card; MARKED; 21 ... 30 (10x); not stretchable; Horizontal marking; snap-on type; white	<a href="http://www.wago.com/793-504">www.wago.com/793-504</a>
	<b>Item no.: 793-504/000-002</b> WMB marking card; as card; MARKED; 21 ... 30 (10x); not stretchable; Horizontal marking; snap-on type; yellow	<a href="http://www.wago.com/793-504/000-002">www.wago.com/793-504/000-002</a>
	<b>Item no.: 793-504/000-005</b> WMB marking card; as card; MARKED; 21 ... 30 (10x); not stretchable; Horizontal marking; snap-on type; red	<a href="http://www.wago.com/793-504/000-005">www.wago.com/793-504/000-005</a>
	<b>Item no.: 793-504/000-006</b> WMB marking card; as card; MARKED; 21 ... 30 (10x); not stretchable; Horizontal marking; snap-on type; blue	<a href="http://www.wago.com/793-504/000-006">www.wago.com/793-504/000-006</a>
	<b>Item no.: 793-504/000-012</b> WMB marking card; as card; MARKED; 21 ... 30 (10x); not stretchable; Horizontal marking; snap-on type; orange	<a href="http://www.wago.com/793-504/000-012">www.wago.com/793-504/000-012</a>
	<b>Item no.: 793-504/000-017</b> WMB marking card; as card; MARKED; 21 ... 30 (10x); not stretchable; Horizontal marking; snap-on type; light green	<a href="http://www.wago.com/793-504/000-017">www.wago.com/793-504/000-017</a>
	<b>Item no.: 793-504/000-023</b> WMB marking card; as card; MARKED; 21 ... 30 (10x); not stretchable; Horizontal marking; snap-on type; green	<a href="http://www.wago.com/793-504/000-023">www.wago.com/793-504/000-023</a>
	<b>Item no.: 793-505</b> WMB marking card; as card; MARKED; 31 ... 40 (10x); not stretchable; Horizontal marking; snap-on type; white	<a href="http://www.wago.com/793-505">www.wago.com/793-505</a>
	<b>Item no.: 793-505/000-005</b> WMB marking card; as card; MARKED; 31 ... 40 (10x); not stretchable; Horizontal marking; snap-on type; red	<a href="http://www.wago.com/793-505/000-005">www.wago.com/793-505/000-005</a>
	<b>Item no.: 793-505/000-006</b> WMB marking card; as card; MARKED; 31 ... 40 (10x); not stretchable; Horizontal marking; snap-on type;	

Subject to changes. Please also observe the further product documentation!



blue

[www.wago.com/793-505/000-006](http://www.wago.com/793-505/000-006)



**Item no.: 793-505/000-007**

WMB marking card; as card; MARKED; 31 ... 40 (10x); not stretchable; Horizontal marking; snap-on type; gray

[www.wago.com/793-505/000-007](http://www.wago.com/793-505/000-007)



**Item no.: 793-505/000-012**

WMB marking card; as card; MARKED; 31 ... 40 (10x); not stretchable; Horizontal marking; snap-on type; orange

[www.wago.com/793-505/000-012](http://www.wago.com/793-505/000-012)



**Item no.: 793-506**

WMB marking card; as card; MARKED; 41 ... 50 (10x); not stretchable; Horizontal marking; snap-on type; white

[www.wago.com/793-506](http://www.wago.com/793-506)



**Item no.: 793-506/000-005**

WMB marking card; as card; MARKED; 41 ... 50 (10x); not stretchable; Horizontal marking; snap-on type; red

[www.wago.com/793-506/000-005](http://www.wago.com/793-506/000-005)



**Item no.: 793-506/000-006**

WMB marking card; as card; MARKED; 41 ... 50 (10x); not stretchable; Horizontal marking; snap-on type; blue

[www.wago.com/793-506/000-006](http://www.wago.com/793-506/000-006)



**Item no.: 793-506/000-012**

WMB marking card; as card; MARKED; 41 ... 50 (10x); not stretchable; Horizontal marking; snap-on type; orange

[www.wago.com/793-506/000-012](http://www.wago.com/793-506/000-012)



**Item no.: 793-506/000-017**

WMB marking card; as card; MARKED; 41 ... 50 (10x); not stretchable; Horizontal marking; snap-on type; light green

[www.wago.com/793-506/000-017](http://www.wago.com/793-506/000-017)



**Item no.: 793-5501**

WMB marking card; as card; for terminal block width 5 - 17.5 mm; stretchable 5 - 5.2 mm; plain; snap-on type; white

[www.wago.com/793-5501](http://www.wago.com/793-5501)



**Item no.: 793-5501/000-002**

WMB marking card; as card; for terminal block width 5 - 17.5 mm; stretchable 5 - 5.2 mm; plain; snap-on type; yellow

[www.wago.com/793-5501/000-002](http://www.wago.com/793-5501/000-002)



**Item no.: 793-5501/000-005**

WMB marking card; as card; for terminal block width 5 - 17.5 mm; stretchable 5 - 5.2 mm; plain; snap-on type; red

[www.wago.com/793-5501/000-005](http://www.wago.com/793-5501/000-005)



**Item no.: 793-5501/000-006**

WMB marking card; as card; for terminal block width 5 - 17.5 mm; stretchable 5 - 5.2 mm; plain; snap-on type; blue

[www.wago.com/793-5501/000-006](http://www.wago.com/793-5501/000-006)



**Item no.: 793-5501/000-007**

WMB marking card; as card; for terminal block width 5 - 17.5 mm; stretchable 5 - 5.2 mm; plain; snap-on type; gray

[www.wago.com/793-5501/000-007](http://www.wago.com/793-5501/000-007)

**Item no.: 793-5501/000-012**

WMB marking card; as card; for terminal block width 5 - 17.5 mm; stretchable 5 - 5.2 mm; plain; snap-on

Subject to changes. Please also observe the further product documentation!



type; orange

[www.wago.com/793-5501/000-012](http://www.wago.com/793-5501/000-012)
**Item no.: 793-5501/000-014**

WMB marking card; as card; for terminal block width 5 - 17.5 mm; stretchable 5 - 5.2 mm; plain; snap-on type; brown

[www.wago.com/793-5501/000-014](http://www.wago.com/793-5501/000-014)
**Item no.: 793-5501/000-017**

WMB marking card; as card; for terminal block width 5 - 17.5 mm; stretchable 5 - 5.2 mm; plain; snap-on type; green

[www.wago.com/793-5501/000-017](http://www.wago.com/793-5501/000-017)
**Item no.: 793-5501/000-023**

WMB marking card; as card; for terminal block width 5 - 17.5 mm; stretchable 5 - 5.2 mm; plain; snap-on type; light green

[www.wago.com/793-5501/000-023](http://www.wago.com/793-5501/000-023)
**Item no.: 793-5501/000-024**

WMB marking card; as card; for terminal block width 5 - 17.5 mm; stretchable 5 - 5.2 mm; plain; snap-on type; violet

[www.wago.com/793-5501/000-024](http://www.wago.com/793-5501/000-024)
**Item no.: 793-566**

WMB marking card; as card; MARKED; 1 ... 50 (2x); not stretchable; Horizontal marking; snap-on type; white

[www.wago.com/793-566](http://www.wago.com/793-566)
**Item no.: 793-566/000-002**

WMB marking card; as card; MARKED; 1 ... 50 (2x); not stretchable; Horizontal marking; snap-on type; yellow

[www.wago.com/793-566/000-002](http://www.wago.com/793-566/000-002)
**Item no.: 793-566/000-005**

WMB marking card; as card; MARKED; 1 ... 50 (2x); not stretchable; Horizontal marking; snap-on type; red

[www.wago.com/793-566/000-005](http://www.wago.com/793-566/000-005)
**Item no.: 793-566/000-006**

WMB marking card; as card; MARKED; 1 ... 50 (2x); not stretchable; Horizontal marking; snap-on type; blue

[www.wago.com/793-566/000-006](http://www.wago.com/793-566/000-006)
**Item no.: 793-566/000-007**

WMB marking card; as card; MARKED; 1 ... 50 (2x); not stretchable; Horizontal marking; snap-on type; gray

[www.wago.com/793-566/000-007](http://www.wago.com/793-566/000-007)
**Item no.: 793-566/000-012**

WMB marking card; as card; MARKED; 1 ... 50 (2x); not stretchable; Horizontal marking; snap-on type; orange

[www.wago.com/793-566/000-012](http://www.wago.com/793-566/000-012)
**Item no.: 793-566/000-017**

WMB marking card; as card; MARKED; 1 ... 50 (2x); not stretchable; Horizontal marking; snap-on type; light green

[www.wago.com/793-566/000-017](http://www.wago.com/793-566/000-017)
**Item no.: 793-566/000-023**

WMB marking card; as card; MARKED; 1 ... 50 (2x); not stretchable; Horizontal marking; snap-on type; green

[www.wago.com/793-566/000-023](http://www.wago.com/793-566/000-023)
**Item no.: 793-566/000-024**

Subject to changes. Please also observe the further product documentation!

WAGO Kontakttechnik GmbH &amp; Co. KG

Hansastr. 27

32423 Minden

Phone: +49571 887-0 | Fax: +49571 887-169

Email: [info.de@wago.com](mailto:info.de@wago.com) | Web: [www.wago.com](http://www.wago.com)

Do you have any questions about our products?

We are always happy to take your call at +49 (571) 887-44222.



WMB marking card; as card; MARKED; 1 ... 50 (2x); not stretchable; Horizontal marking; snap-on type; violet

[www.wago.com/793-566/000-024](http://www.wago.com/793-566/000-024)

**ferrule**



**Item no.: 216-241**

Ferrule; Sleeve for 0.5 mm<sup>2</sup> / 20 AWG; insulated; electro-tin plated; electrolytic copper; gastight crimped; acc. to DIN 46228, Part 4/09.90; white

[www.wago.com/216-241](http://www.wago.com/216-241)



**Item no.: 216-242**

Ferrule; Sleeve for 0.75 mm<sup>2</sup> / 18 AWG; insulated; electro-tin plated; electrolytic copper; gastight crimped; acc. to DIN 46228, Part 4/09.90; gray

[www.wago.com/216-242](http://www.wago.com/216-242)



**Item no.: 216-243**

Ferrule; Sleeve for 1 mm<sup>2</sup> / AWG 18; insulated; electro-tin plated; electrolytic copper; gastight crimped; acc. to DIN 46228, Part 4/09.90; red

[www.wago.com/216-243](http://www.wago.com/216-243)



**Item no.: 216-244**

Ferrule; Sleeve for 1.5 mm<sup>2</sup> / AWG 16; insulated; electro-tin plated; electrolytic copper; gastight crimped; acc. to DIN 46228, Part 4/09.90; black

[www.wago.com/216-244](http://www.wago.com/216-244)



**Item no.: 216-542**

Twin ferrule; Sleeve for 2 x 1 mm<sup>2</sup> / AWG 2 x 18; red, insulated; 12 mm long; red

[www.wago.com/216-542](http://www.wago.com/216-542)

**Downloads**

**Documentation**

**Bid Text**

788-312 X81 - Datei	Feb 19, 2019	xml 4.7 kB	Download
------------------------	--------------	---------------	----------

788-312 docx - Datei	Jan 25, 2019	docx 16.8 kB	Download
-------------------------	--------------	-----------------	----------

**Instruction Leaflet**

Sockets with Elementary Relay/ SSR	V 1.0.0	pdf 2.4 MB	Download
------------------------------------	---------	---------------	----------

**Additional Information**

Disposal; Electrical and electronic equipment, Packaging	V 1.0.0	pdf 265.8 kB	Download
--	---------	-----------------	----------

**CAD/CAE-Data**

**CAD data**

2D/3D Models 788-312		URL	Download
----------------------	--	-----	----------

Subject to changes. Please also observe the further product documentation!

WAGO Kontakttechnik GmbH & Co. KG

Hansastr. 27

32423 Minden

Phone: +49571 887-0 | Fax: +49571 887-169

Email: [info.de@wago.com](mailto:info.de@wago.com) | Web: [www.wago.com](http://www.wago.com)

Do you have any questions about our products?

We are always happy to take your call at +49 (571) 887-44222.

## CAE data

EPLAN Data Portal 788-312	<a href="#">URL</a>	<a href="#">Download</a>
WSCAD Universe 788-312	<a href="#">URL</a>	<a href="#">Download</a>

## Installation Notes

### Conductor termination

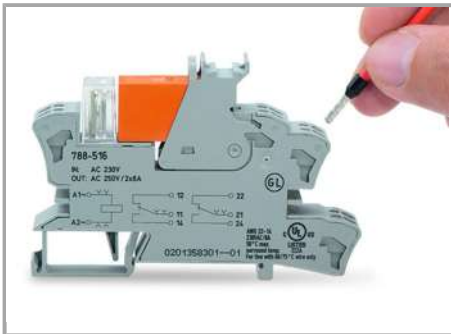

### Leiter anschließen

### Commoning

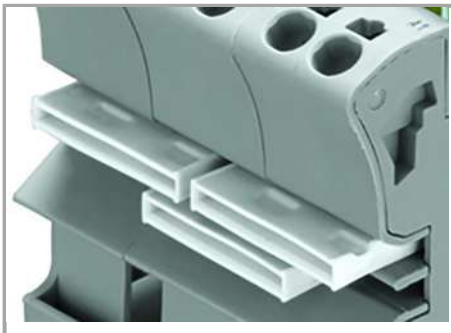

Easy commoning using adjacent jumpers

### Marking

Subject to changes. Please also observe the further product documentation!

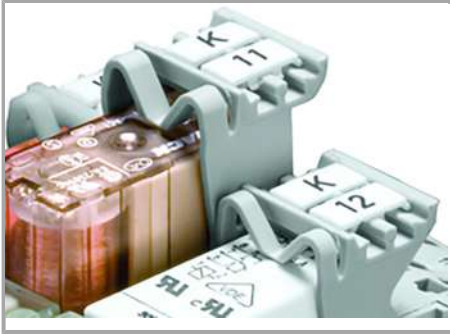

Marking using WMB Multi markers and group marker carriers

Subject to changes. Please also observe the further product documentation!