

**Data sheet | Item number: 788-404**

Relay module; Nominal input voltage: 24 VDC; 1 changeover contact;  
Limiting continuous current: 16 A; with gold contacts; Red status indicator;  
Module width: 15 mm; 2,50 mm<sup>2</sup>; gray

[www.wago.com/788-404](http://www.wago.com/788-404)

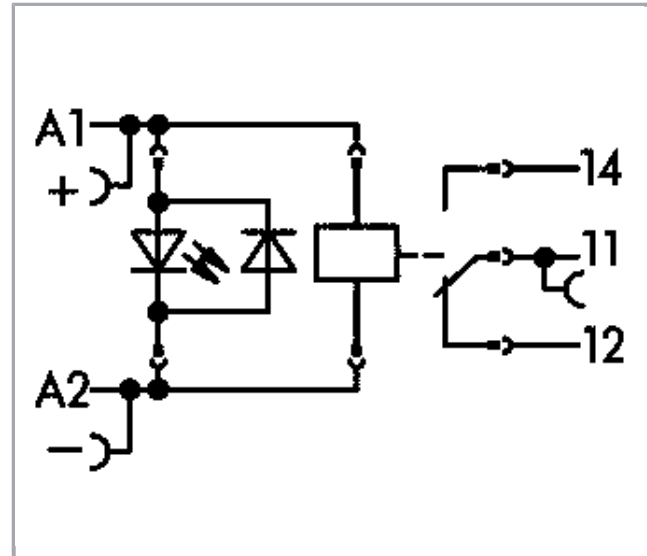
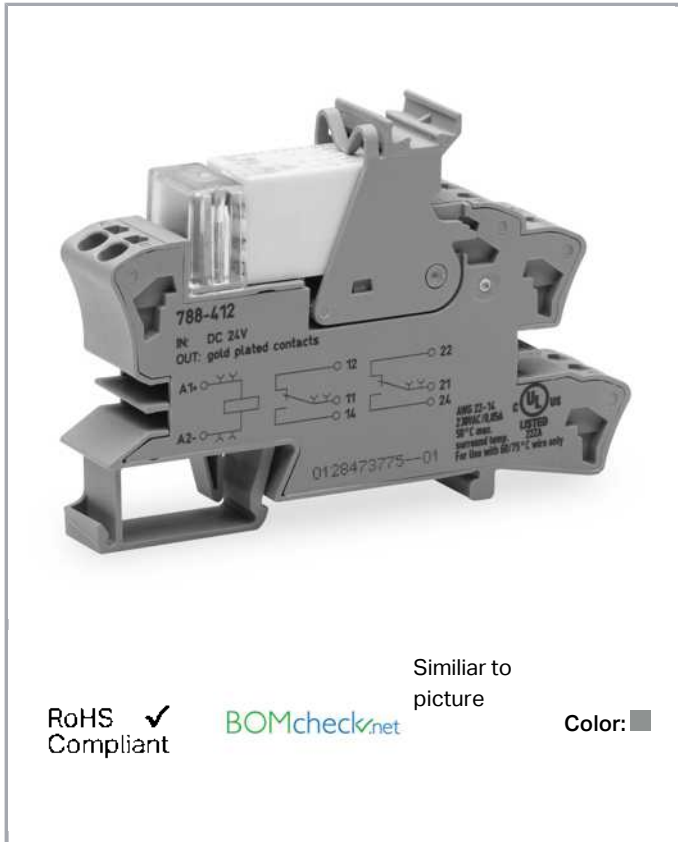

Similar to  
picture

RoHS  Compliant

BOMcheck.net

Color: ■

Subject to changes. Please also observe the further product documentation!

WAGO Kontakttechnik GmbH & Co. KG  
Hansastr. 27  
32423 Minden  
Phone: +49571 887-0 | Fax: +49571 887-169  
Email: [info.de@wago.com](mailto:info.de@wago.com) | Web: [www.wago.com](http://www.wago.com)

Do you have any questions about our products?  
We are always happy to take your call at +49 (571) 887-44222.

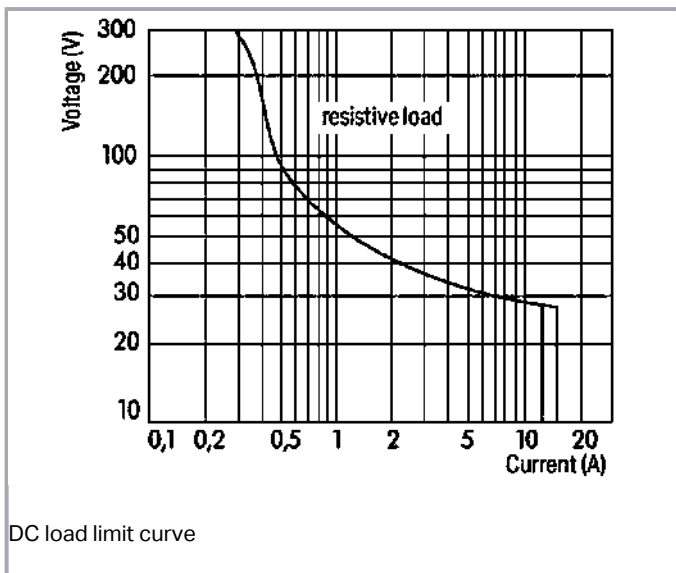
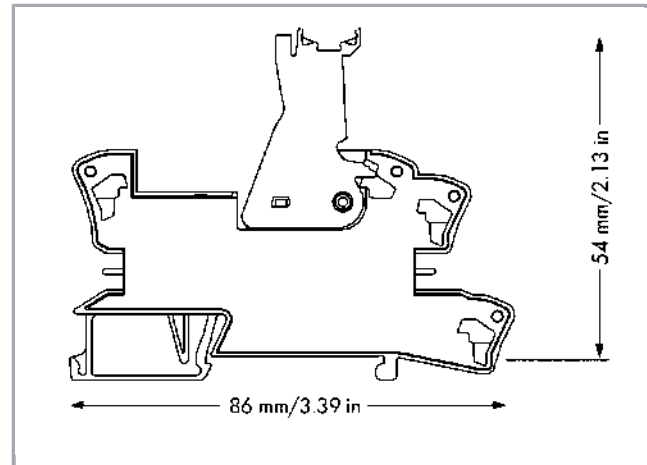
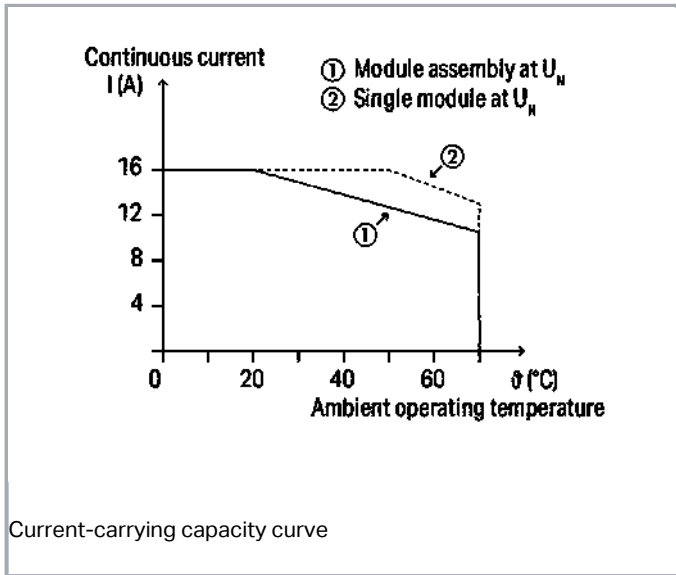

## Item description

### Note:

- Reinforced insulation between coil and contacts
- A separator plate (e.g., 209-191) must be used for voltages greater than 250 V between adjacent relay modules and for compliance with the reinforced insulation requirements.
- To prevent damaging the gold layer, 30 VDC switching voltages and 50 mA currents shall not be exceeded. Higher switching power evaporates the gold layer. The resulting deposits in the housing may reduce the service life.
- Inductive loads have to be attenuated by an appropriate protective circuit in order to protect relay coils and contacts.

Subject to changes. Please also observe the further product documentation!



## Data

### Technical Data

#### Control circuit

Nominal input voltage $U_N$	DC 24 V
Input voltage range	$\pm 10\%$
Nominal input current at $U_N$	19 mA

#### Load circuit:

Number of changeover/switchover contacts	1
Contact material (relay)	AgNi + Au
Limiting continuous current	16 A
Max. switching voltage	AC 250 V
Max. switching power (resistive)	AC 4000 VA; DC see load limit curve
Switching capacity	AC-15: 6 A / AC 250 V; DC-13: 2 A / DC 24 V
Recommended minimum load	5 V / 2 mA / 50 mW
Pull-in time (typ.)	7 ms
Drop-out time (typ.)	3 ms
Bounce time (typ.)	6 ms
Electrical life (N.O.; resistive load; 23 °C)	$70 \times 10^3$ switching operations
Mechanical life	$30 \times 10^6$ switching operations
Max. switching load with load/without load	$10 \text{ min}^{-1}$ / $1200 \text{ min}^{-1}$

#### Signaling

Status indication	LED red
-------------------	---------

#### Safety and protection:

Rated voltage	250 V
Rated impulse voltage	4 kV
Pollution degree	3
Dielectric strength, control/load circuit (AC, 1 min)	5 kVrms
Dielectric strength open contact (AC, 1 min)	1 kVrms
Protection class	IP20

Subject to changes. Please also observe the further product documentation!

WAGO Kontakttechnik GmbH & Co. KG  
 Hansastr. 27  
 32423 Minden  
 Phone: +49571 887-0 | Fax: +49571 887-169  
 Email: [info.de@wago.com](mailto:info.de@wago.com) | Web: [www.wago.com](http://www.wago.com)

Do you have any questions about our products?  
 We are always happy to take your call at +49 (571) 887-44222.



## Connection data

Connection technology	Push-in CAGE CLAMP®
Solid conductor	0,34 ... 2,5 mm <sup>2</sup> / 22 ... 14 AWG
Fine-stranded conductor	0,34 ... 2,5 mm <sup>2</sup> / 22 ... 14 AWG
Strip length	9 ... 10 mm / 0.35 ... 0.39 inch

## Geometrical Data

Width	15 mm / 0.591 inch
Height from upper-edge of DIN-35 rail	54 mm / 2.126 inch
Depth	86 mm / 3.386 inch

## Mechanical data

Type of mounting	DIN-35 rail
------------------	-------------

## Material Data

Color	gray
Fire load	0.665 MJ
Weight	46.1 g

## Environmental Requirements

Surrounding air (operating) temperature at U <sub>N</sub>	-40 ... 70 °C
Surrounding air (storage) temperature	-40 ... 70 °C
Processing temperature	-25 ... +50 °C

## Standards and specifications

Standards/specifications	EN 61010-2-201; EN 61810-1; EN 61373; UL 508
--------------------------	--

## Elementary relay

WAGO elementary relay	788-155
-----------------------	---------

## Commercial data

Product Group	6 (Interface Electronics)
Packaging type	BOX
Country of origin	DE

Subject to changes. Please also observe the further product documentation!

WAGO Kontakttechnik GmbH & Co. KG  
 Hansastr. 27  
 32423 Minden  
 Phone: +49571 887-0 | Fax: +49571 887-169  
 Email: [info.de@wago.com](mailto:info.de@wago.com) | Web: [www.wago.com](http://www.wago.com)

Do you have any questions about our products?  
 We are always happy to take your call at +49 (571) 887-44222.

GTIN	4045454352158
Customs Tariff No.	85364900990

## Approvals / Certificates









### UL-Approvals

Logo	Approval	Additional Approval Text	Certificate name
	<b>UL</b> UL International Netherlands B.V. (ORDINARY LOCATIONS)	UL 508	E175199 Sec.6















## Counterpart

## Compatible products















### Jumper

	<b>Item no.: 788-113</b> Comb-style jumper bar; 2-way; insulated	<a href="http://www.wago.com/788-113">www.wago.com/788-113</a>
	<b>Item no.: 788-114</b> Comb-style jumper bar; 3-way; insulated	<a href="http://www.wago.com/788-114">www.wago.com/788-114</a>
	<b>Item no.: 788-115</b> Comb-style jumper bar; 4-way; insulated	<a href="http://www.wago.com/788-115">www.wago.com/788-115</a>
	<b>Item no.: 788-116</b> Comb-style jumper bar; 6-way; insulated	<a href="http://www.wago.com/788-116">www.wago.com/788-116</a>
	<b>Item no.: 788-117</b> Comb-style jumper bar; 8-way; insulated	<a href="http://www.wago.com/788-117">www.wago.com/788-117</a>
	<b>Item no.: 788-118</b> Comb-style jumper bar; 2-way (1-3); insulated	<a href="http://www.wago.com/788-118">www.wago.com/788-118</a>
	<b>Item no.: 859-402</b> Push-in type jumper bar; 2-way; Nominal current 18 A; insulated; light gray	<a href="http://www.wago.com/859-402">www.wago.com/859-402</a>
	<b>Item no.: 859-402/000-005</b> Push-in type jumper bar; 2-way; Nominal current 18 A; insulated; red	<a href="http://www.wago.com/859-402/000-005">www.wago.com/859-402/000-005</a>













Subject to changes. Please also observe the further product documentation!

	<b>Item no.: 859-402/000-006</b> Push-in type jumper bar; 2-way; Nominal current 18 A; insulated; blue	<a href="http://www.wago.com/859-402/000-006">www.wago.com/859-402/000-006</a>
	<b>Item no.: 859-402/000-029</b> Push-in type jumper bar; 2-way; Nominal current 18 A; insulated; yellow	<a href="http://www.wago.com/859-402/000-029">www.wago.com/859-402/000-029</a>
<b>ferrule</b>		
	<b>Item no.: 216-241</b> Ferrule; Sleeve for 0.5 mm <sup>2</sup> / 20 AWG; insulated; electro-tin plated; electrolytic copper; gastight crimped; acc. to DIN 46228, Part 4/09.90; white	<a href="http://www.wago.com/216-241">www.wago.com/216-241</a>
	<b>Item no.: 216-242</b> Ferrule; Sleeve for 0.75 mm <sup>2</sup> / 18 AWG; insulated; electro-tin plated; electrolytic copper; gastight crimped; acc. to DIN 46228, Part 4/09.90; gray	<a href="http://www.wago.com/216-242">www.wago.com/216-242</a>
	<b>Item no.: 216-243</b> Ferrule; Sleeve for 1 mm <sup>2</sup> / AWG 18; insulated; electro-tin plated; electrolytic copper; gastight crimped; acc. to DIN 46228, Part 4/09.90; red	<a href="http://www.wago.com/216-243">www.wago.com/216-243</a>
	<b>Item no.: 216-244</b> Ferrule; Sleeve for 1.5 mm <sup>2</sup> / AWG 16; insulated; electro-tin plated; electrolytic copper; gastight crimped; acc. to DIN 46228, Part 4/09.90; black	<a href="http://www.wago.com/216-244">www.wago.com/216-244</a>
	<b>Item no.: 216-542</b> Twin ferrule; Sleeve for 2 x 1 mm <sup>2</sup> / AWG 2 x 18; red, insulated; 12 mm long; red	<a href="http://www.wago.com/216-542">www.wago.com/216-542</a>
<b>General accessories</b>		
	<b>Item no.: 209-145</b> Group marker carrier; white	<a href="http://www.wago.com/209-145">www.wago.com/209-145</a>
	<b>Item no.: 209-184</b> Protection cover; transparent	<a href="http://www.wago.com/209-184">www.wago.com/209-184</a>
	<b>Item no.: 788-120</b> Accessories for relay modules; Operation status indicator: red	<a href="http://www.wago.com/788-120">www.wago.com/788-120</a>
	<b>Item no.: 788-155</b> Basic relay; Nominal input voltage: 24 VDC; 1 changeover contact; Limiting continuous current: 16 A; with gold contacts; Module width: 13 mm; Module height: 15 mm	<a href="http://www.wago.com/788-155">www.wago.com/788-155</a>
<b>tools</b>		
	<b>Item no.: 210-720</b> Operating tool; Blade: 3.5 x 0.5 mm; with a partially insulated shaft	<a href="http://www.wago.com/210-720">www.wago.com/210-720</a>
<b>Marking accessories</b>		
	<b>Item no.: 2009-110</b> Marking strips; on reel; not stretchable; plain; snap-on type; white	<a href="http://www.wago.com/2009-110">www.wago.com/2009-110</a>
	<b>Item no.: 2009-115</b> WMB-Inline; for Smart Printer; 1500 pieces on roll; stretchable 5 - 5.2 mm; plain; snap-on type; white	<a href="http://www.wago.com/2009-115">www.wago.com/2009-115</a>
	<b>Item no.: 2009-115/000-002</b> WMB-Inline; for Smart Printer; 1500 pieces on roll; stretchable 5 - 5.2 mm; plain; snap-on type; yellow	<a href="http://www.wago.com/2009-115/000-002">www.wago.com/2009-115/000-002</a>

Subject to changes. Please also observe the further product documentation!

	<b>Item no.: 2009-115/000-006</b> WMB-Inline; for Smart Printer; 1500 pieces on roll; stretchable 5 - 5.2 mm; plain; snap-on type; white	<a href="http://www.wago.com/2009-115/000-006">www.wago.com/2009-115/000-006</a>
	<b>Item no.: 2009-115/000-007</b> WMB-Inline; for Smart Printer; 1500 pieces on roll; stretchable 5 - 5.2 mm; plain; snap-on type; gray	<a href="http://www.wago.com/2009-115/000-007">www.wago.com/2009-115/000-007</a>
	<b>Item no.: 2009-115/000-012</b> WMB-Inline; for Smart Printer; 1500 pieces on roll; stretchable 5 - 5.2 mm; plain; snap-on type; white	<a href="http://www.wago.com/2009-115/000-012">www.wago.com/2009-115/000-012</a>
	<b>Item no.: 2009-115/000-017</b> WMB-Inline; for Smart Printer; 1500 pieces on roll; stretchable 5 - 5.2 mm; plain; snap-on type; white	<a href="http://www.wago.com/2009-115/000-017">www.wago.com/2009-115/000-017</a>
	<b>Item no.: 2009-115/000-023</b> WMB-Inline; for Smart Printer; 1500 pieces on roll; stretchable 5 - 5.2 mm; plain; snap-on type; green	<a href="http://www.wago.com/2009-115/000-023">www.wago.com/2009-115/000-023</a>
	<b>Item no.: 209-128</b> Adaptor; gray	<a href="http://www.wago.com/209-128">www.wago.com/209-128</a>
	<b>Item no.: 209-183</b> Marker card; white	<a href="http://www.wago.com/209-183">www.wago.com/209-183</a>
	<b>Item no.: 210-110</b> Fiber-tip pen	<a href="http://www.wago.com/210-110">www.wago.com/210-110</a>
	<b>Item no.: 249-105</b> Group marker carrier; gray	<a href="http://www.wago.com/249-105">www.wago.com/249-105</a>
	<b>Item no.: 793-501</b> WMB marking card; as card; not stretchable; plain; snap-on type; white	<a href="http://www.wago.com/793-501">www.wago.com/793-501</a>
	<b>Item no.: 793-501/000-002</b> WMB marking card; as card; not stretchable; plain; snap-on type; yellow	<a href="http://www.wago.com/793-501/000-002">www.wago.com/793-501/000-002</a>
	<b>Item no.: 793-501/000-005</b> WMB marking card; as card; not stretchable; plain; snap-on type; red	<a href="http://www.wago.com/793-501/000-005">www.wago.com/793-501/000-005</a>
	<b>Item no.: 793-501/000-006</b> WMB marking card; as card; not stretchable; plain; snap-on type; blue	<a href="http://www.wago.com/793-501/000-006">www.wago.com/793-501/000-006</a>
	<b>Item no.: 793-501/000-007</b> WMB marking card; as card; not stretchable; plain; snap-on type; gray	<a href="http://www.wago.com/793-501/000-007">www.wago.com/793-501/000-007</a>
	<b>Item no.: 793-501/000-012</b> WMB marking card; as card; not stretchable; plain; snap-on type; orange	<a href="http://www.wago.com/793-501/000-012">www.wago.com/793-501/000-012</a>

Subject to changes. Please also observe the further product documentation!

	<b>Item no.: 793-501/000-017</b> WMB marking card; as card; not stretchable; plain; snap-on type; light green	<a href="http://www.wago.com/793-501/000-017">www.wago.com/793-501/000-017</a>
	<b>Item no.: 793-501/000-023</b> WMB marking card; as card; not stretchable; plain; snap-on type; green	<a href="http://www.wago.com/793-501/000-023">www.wago.com/793-501/000-023</a>
	<b>Item no.: 793-501/000-024</b> WMB marking card; as card; not stretchable; plain; snap-on type; violet	<a href="http://www.wago.com/793-501/000-024">www.wago.com/793-501/000-024</a>
	<b>Item no.: 793-502</b> WMB marking card; as card; MARKED; 1 ... 10 (10x); not stretchable; Horizontal marking; snap-on type; white	<a href="http://www.wago.com/793-502">www.wago.com/793-502</a>
	<b>Item no.: 793-502/000-002</b> WMB marking card; as card; MARKED; 1 ... 10 (10x); not stretchable; Horizontal marking; snap-on type; yellow	<a href="http://www.wago.com/793-502/000-002">www.wago.com/793-502/000-002</a>
	<b>Item no.: 793-502/000-005</b> WMB marking card; as card; MARKED; 1 ... 10 (10x); not stretchable; Horizontal marking; snap-on type; red	<a href="http://www.wago.com/793-502/000-005">www.wago.com/793-502/000-005</a>
	<b>Item no.: 793-502/000-006</b> WMB marking card; as card; MARKED; 1 ... 10 (10x); not stretchable; Horizontal marking; snap-on type; blue	<a href="http://www.wago.com/793-502/000-006">www.wago.com/793-502/000-006</a>
	<b>Item no.: 793-502/000-007</b> WMB marking card; as card; MARKED; 1 ... 10 (10x); not stretchable; Horizontal marking; snap-on type; gray	<a href="http://www.wago.com/793-502/000-007">www.wago.com/793-502/000-007</a>
	<b>Item no.: 793-502/000-012</b> WMB marking card; as card; MARKED; 1 ... 10 (10x); not stretchable; Horizontal marking; snap-on type; orange	<a href="http://www.wago.com/793-502/000-012">www.wago.com/793-502/000-012</a>
	<b>Item no.: 793-502/000-017</b> WMB marking card; as card; MARKED; 1 ... 10 (10x); not stretchable; Horizontal marking; snap-on type; light green	<a href="http://www.wago.com/793-502/000-017">www.wago.com/793-502/000-017</a>
	<b>Item no.: 793-502/000-023</b> WMB marking card; as card; MARKED; 1 ... 10 (10x); not stretchable; Horizontal marking; snap-on type; green	<a href="http://www.wago.com/793-502/000-023">www.wago.com/793-502/000-023</a>
	<b>Item no.: 793-502/000-024</b> WMB marking card; as card; MARKED; 1 ... 10 (10x); not stretchable; Horizontal marking; snap-on type; violet	<a href="http://www.wago.com/793-502/000-024">www.wago.com/793-502/000-024</a>
	<b>Item no.: 793-503</b> WMB marking card; as card; MARKED; 11 ... 20 (10x); not stretchable; Horizontal marking; snap-on type; white	<a href="http://www.wago.com/793-503">www.wago.com/793-503</a>

Subject to changes. Please also observe the further product documentation!





**Item no.: 793-503/000-002**

WMB marking card; as card; MARKED; 11 ... 20 (10x); not stretchable; Horizontal marking; snap-on type; yellow [www.wago.com/793-503/000-002](http://www.wago.com/793-503/000-002)



**Item no.: 793-503/000-005**

WMB marking card; as card; MARKED; 11 ... 20 (10x); not stretchable; Horizontal marking; snap-on type; red [www.wago.com/793-503/000-005](http://www.wago.com/793-503/000-005)



**Item no.: 793-503/000-006**

WMB marking card; as card; MARKED; 11 ... 20 (10x); not stretchable; Horizontal marking; snap-on type; blue [www.wago.com/793-503/000-006](http://www.wago.com/793-503/000-006)



**Item no.: 793-503/000-007**

WMB marking card; as card; MARKED; 11 ... 20 (10x); not stretchable; Horizontal marking; snap-on type; gray [www.wago.com/793-503/000-007](http://www.wago.com/793-503/000-007)



**Item no.: 793-503/000-012**

WMB marking card; as card; MARKED; 11 ... 20 (10x); not stretchable; Horizontal marking; snap-on type; orange [www.wago.com/793-503/000-012](http://www.wago.com/793-503/000-012)



**Item no.: 793-503/000-017**

WMB marking card; as card; MARKED; 11 ... 20 (10x); not stretchable; Horizontal marking; snap-on type; light green [www.wago.com/793-503/000-017](http://www.wago.com/793-503/000-017)



**Item no.: 793-503/000-023**

WMB marking card; as card; MARKED; 11 ... 20 (10x); not stretchable; Horizontal marking; snap-on type; green [www.wago.com/793-503/000-023](http://www.wago.com/793-503/000-023)



**Item no.: 793-503/000-024**

WMB marking card; as card; MARKED; 11 ... 20 (10x); not stretchable; Horizontal marking; snap-on type; violet [www.wago.com/793-503/000-024](http://www.wago.com/793-503/000-024)



**Item no.: 793-504**

WMB marking card; as card; MARKED; 21 ... 30 (10x); not stretchable; Horizontal marking; snap-on type; white [www.wago.com/793-504](http://www.wago.com/793-504)



**Item no.: 793-504/000-002**

WMB marking card; as card; MARKED; 21 ... 30 (10x); not stretchable; Horizontal marking; snap-on type; yellow [www.wago.com/793-504/000-002](http://www.wago.com/793-504/000-002)



**Item no.: 793-504/000-005**

WMB marking card; as card; MARKED; 21 ... 30 (10x); not stretchable; Horizontal marking; snap-on type; red [www.wago.com/793-504/000-005](http://www.wago.com/793-504/000-005)



**Item no.: 793-504/000-006**

WMB marking card; as card; MARKED; 21 ... 30 (10x); not stretchable; Horizontal marking; snap-on type; blue [www.wago.com/793-504/000-006](http://www.wago.com/793-504/000-006)



**Item no.: 793-504/000-012**

WMB marking card; as card; MARKED; 21 ... 30 (10x); not stretchable; Horizontal marking; snap-on type; orange [www.wago.com/793-504/000-012](http://www.wago.com/793-504/000-012)

**Item no.: 793-504/000-017**

Subject to changes. Please also observe the further product documentation!



WMB marking card; as card; MARKED; 21 ... 30 (10x); not stretchable; Horizontal marking; snap-on type; light green

[www.wago.com/793-504/000-017](http://www.wago.com/793-504/000-017)



**Item no.: 793-504/000-023**

WMB marking card; as card; MARKED; 21 ... 30 (10x); not stretchable; Horizontal marking; snap-on type; green

[www.wago.com/793-504/000-023](http://www.wago.com/793-504/000-023)



**Item no.: 793-505**

WMB marking card; as card; MARKED; 31 ... 40 (10x); not stretchable; Horizontal marking; snap-on type; white

[www.wago.com/793-505](http://www.wago.com/793-505)



**Item no.: 793-505/000-005**

WMB marking card; as card; MARKED; 31 ... 40 (10x); not stretchable; Horizontal marking; snap-on type; red

[www.wago.com/793-505/000-005](http://www.wago.com/793-505/000-005)



**Item no.: 793-505/000-006**

WMB marking card; as card; MARKED; 31 ... 40 (10x); not stretchable; Horizontal marking; snap-on type; blue

[www.wago.com/793-505/000-006](http://www.wago.com/793-505/000-006)



**Item no.: 793-505/000-007**

WMB marking card; as card; MARKED; 31 ... 40 (10x); not stretchable; Horizontal marking; snap-on type; gray

[www.wago.com/793-505/000-007](http://www.wago.com/793-505/000-007)



**Item no.: 793-505/000-012**

WMB marking card; as card; MARKED; 31 ... 40 (10x); not stretchable; Horizontal marking; snap-on type; orange

[www.wago.com/793-505/000-012](http://www.wago.com/793-505/000-012)



**Item no.: 793-506**

WMB marking card; as card; MARKED; 41 ... 50 (10x); not stretchable; Horizontal marking; snap-on type; white

[www.wago.com/793-506](http://www.wago.com/793-506)



**Item no.: 793-506/000-005**

WMB marking card; as card; MARKED; 41 ... 50 (10x); not stretchable; Horizontal marking; snap-on type; red

[www.wago.com/793-506/000-005](http://www.wago.com/793-506/000-005)



**Item no.: 793-506/000-006**

WMB marking card; as card; MARKED; 41 ... 50 (10x); not stretchable; Horizontal marking; snap-on type; blue

[www.wago.com/793-506/000-006](http://www.wago.com/793-506/000-006)



**Item no.: 793-506/000-012**

WMB marking card; as card; MARKED; 41 ... 50 (10x); not stretchable; Horizontal marking; snap-on type; orange

[www.wago.com/793-506/000-012](http://www.wago.com/793-506/000-012)



**Item no.: 793-506/000-017**

WMB marking card; as card; MARKED; 41 ... 50 (10x); not stretchable; Horizontal marking; snap-on type; light green

[www.wago.com/793-506/000-017](http://www.wago.com/793-506/000-017)



**Item no.: 793-5501**

WMB marking card; as card; for terminal block width 5 - 17.5 mm; stretchable 5 - 5.2 mm; plain; snap-on type; white

[www.wago.com/793-5501](http://www.wago.com/793-5501)



**Item no.: 793-5501/000-002**

WMB marking card; as card; for terminal block width 5 - 17.5 mm; stretchable 5 - 5.2 mm; plain; snap-on type; yellow

[www.wago.com/793-5501/000-002](http://www.wago.com/793-5501/000-002)

Subject to changes. Please also observe the further product documentation!

WAGO Kontakttechnik GmbH & Co. KG

Hansastr. 27













32423 Minden

Phone: +49571 887-0 | Fax: +49571 887-169

Email: [info.de@wago.com](mailto:info.de@wago.com) | Web: [www.wago.com](http://www.wago.com)

Do you have any questions about our products?

We are always happy to take your call at +49 (571) 887-44222.

	<b>Item no.: 793-5501/000-005</b> WMB marking card; as card; for terminal block width 5 - 17.5 mm; stretchable 5 - 5.2 mm; plain; snap-on type; red	<a href="http://www.wago.com/793-5501/000-005">www.wago.com/793-5501/000-005</a>
	<b>Item no.: 793-5501/000-006</b> WMB marking card; as card; for terminal block width 5 - 17.5 mm; stretchable 5 - 5.2 mm; plain; snap-on type; blue	<a href="http://www.wago.com/793-5501/000-006">www.wago.com/793-5501/000-006</a>
	<b>Item no.: 793-5501/000-007</b> WMB marking card; as card; for terminal block width 5 - 17.5 mm; stretchable 5 - 5.2 mm; plain; snap-on type; gray	<a href="http://www.wago.com/793-5501/000-007">www.wago.com/793-5501/000-007</a>
	<b>Item no.: 793-5501/000-012</b> WMB marking card; as card; for terminal block width 5 - 17.5 mm; stretchable 5 - 5.2 mm; plain; snap-on type; orange	<a href="http://www.wago.com/793-5501/000-012">www.wago.com/793-5501/000-012</a>
	<b>Item no.: 793-5501/000-014</b> WMB marking card; as card; for terminal block width 5 - 17.5 mm; stretchable 5 - 5.2 mm; plain; snap-on type; brown	<a href="http://www.wago.com/793-5501/000-014">www.wago.com/793-5501/000-014</a>
	<b>Item no.: 793-5501/000-017</b> WMB marking card; as card; for terminal block width 5 - 17.5 mm; stretchable 5 - 5.2 mm; plain; snap-on type; green	<a href="http://www.wago.com/793-5501/000-017">www.wago.com/793-5501/000-017</a>
	<b>Item no.: 793-5501/000-023</b> WMB marking card; as card; for terminal block width 5 - 17.5 mm; stretchable 5 - 5.2 mm; plain; snap-on type; light green	<a href="http://www.wago.com/793-5501/000-023">www.wago.com/793-5501/000-023</a>
	<b>Item no.: 793-5501/000-024</b> WMB marking card; as card; for terminal block width 5 - 17.5 mm; stretchable 5 - 5.2 mm; plain; snap-on type; violet	<a href="http://www.wago.com/793-5501/000-024">www.wago.com/793-5501/000-024</a>
	<b>Item no.: 793-566</b> WMB marking card; as card; MARKED; 1 ... 50 (2x); not stretchable; Horizontal marking; snap-on type; white	<a href="http://www.wago.com/793-566">www.wago.com/793-566</a>
	<b>Item no.: 793-566/000-002</b> WMB marking card; as card; MARKED; 1 ... 50 (2x); not stretchable; Horizontal marking; snap-on type; yellow	<a href="http://www.wago.com/793-566/000-002">www.wago.com/793-566/000-002</a>
	<b>Item no.: 793-566/000-005</b> WMB marking card; as card; MARKED; 1 ... 50 (2x); not stretchable; Horizontal marking; snap-on type; red	<a href="http://www.wago.com/793-566/000-005">www.wago.com/793-566/000-005</a>
	<b>Item no.: 793-566/000-006</b> WMB marking card; as card; MARKED; 1 ... 50 (2x); not stretchable; Horizontal marking; snap-on type; blue	<a href="http://www.wago.com/793-566/000-006">www.wago.com/793-566/000-006</a>
	<b>Item no.: 793-566/000-007</b> WMB marking card; as card; MARKED; 1 ... 50 (2x); not stretchable; Horizontal marking; snap-on type; gray	<a href="http://www.wago.com/793-566/000-007">www.wago.com/793-566/000-007</a>

Subject to changes. Please also observe the further product documentation!



**Item no.: 793-566/000-012**

WMB marking card; as card; MARKED; 1 ... 50 (2x); not stretchable; Horizontal marking; snap-on type; orange

[www.wago.com/793-566/000-012](http://www.wago.com/793-566/000-012)



**Item no.: 793-566/000-017**

WMB marking card; as card; MARKED; 1 ... 50 (2x); not stretchable; Horizontal marking; snap-on type; light green

[www.wago.com/793-566/000-017](http://www.wago.com/793-566/000-017)



**Item no.: 793-566/000-023**

WMB marking card; as card; MARKED; 1 ... 50 (2x); not stretchable; Horizontal marking; snap-on type; green

[www.wago.com/793-566/000-023](http://www.wago.com/793-566/000-023)



**Item no.: 793-566/000-024**

WMB marking card; as card; MARKED; 1 ... 50 (2x); not stretchable; Horizontal marking; snap-on type; violet

[www.wago.com/793-566/000-024](http://www.wago.com/793-566/000-024)

## Downloads

### Documentation

#### Bid Text

788-404 GAEB docx - Datei	Jan 25, 2019	docx 17.0 kB	Download
788-404 GAEB X81 - Datei	Feb 19, 2019	xml 5.1 kB	Download

#### Instruction Leaflet

Sockets with Elementary Relay/ SSR	V 1.0.0	pdf 2.4 MB	Download
------------------------------------	---------	---------------	----------

#### Additional Information

Disposal; Electrical and electronic equipment, Packaging	V 1.0.0	pdf 265.8 kB	Download
--	---------	-----------------	----------

## CAD/CAE-Data

### CAD data

2D/3D Models 788-404	URL	Download
----------------------	-----	----------

### CAE data

EPLAN Data Portal 788-404	URL	Download
---------------------------	-----	----------

Subject to changes. Please also observe the further product documentation!

## Installation Notes

### Conductor termination

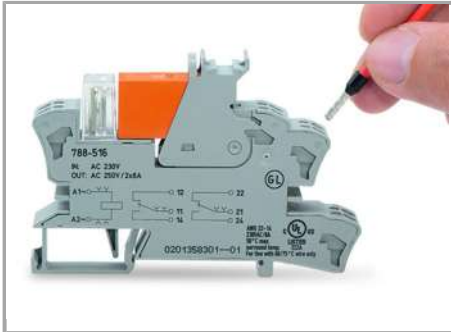

### Leiter anschließen

### Commoning

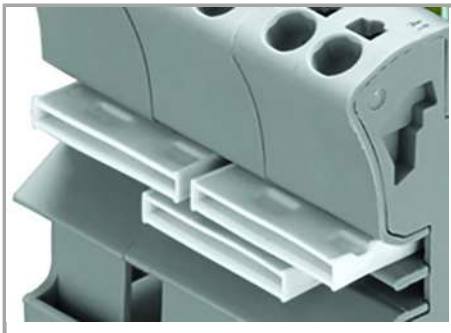

Easy commoning using adjacent jumpers

### Marking

Subject to changes. Please also observe the further product documentation!

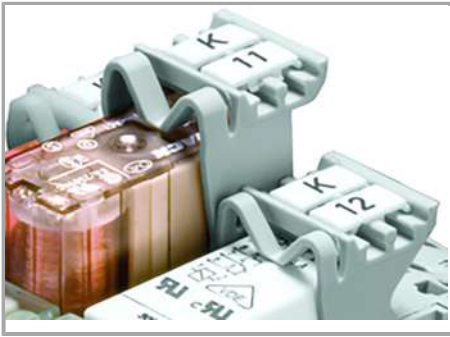

Marking using WMB Multi markers and group marker carriers

Subject to changes. Please also observe the further product documentation!