

## Data sheet | Item number: 789-304

Relay module; Nominal input voltage: 24 VDC; 1 changeover contact;  
Limiting continuous current: 12 A; Red status indicator; Module width: 18  
mm; 2,50 mm<sup>2</sup>; gray

[www.wago.com/789-304](http://www.wago.com/789-304)

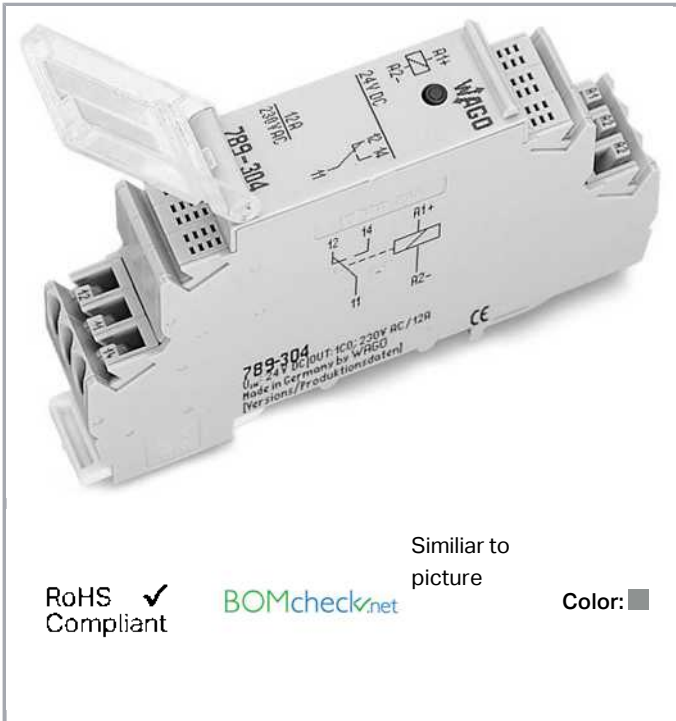

RoHS  
Compliant ✓

BOMcheck.net

Similar to  
picture

Color: ■

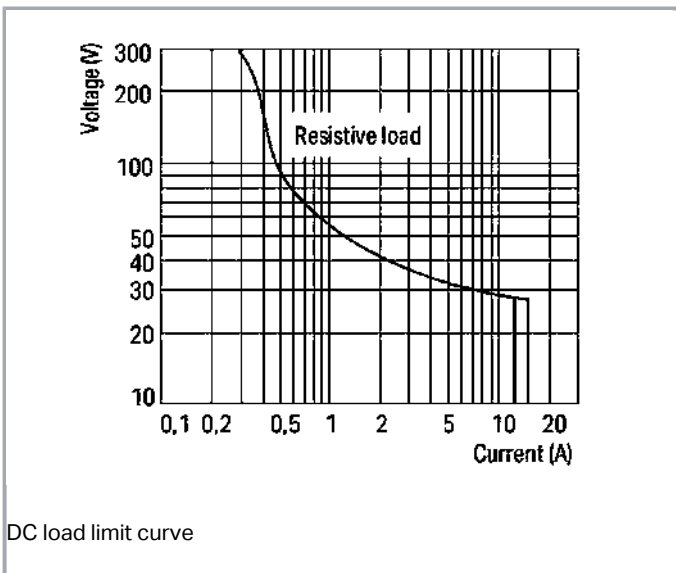
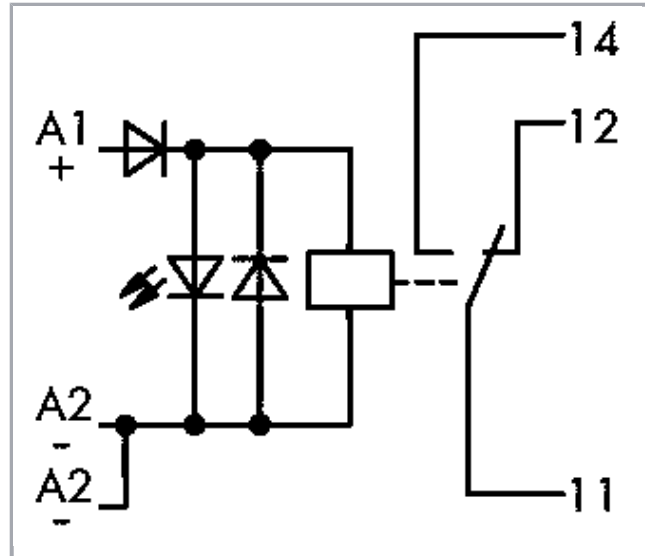

DC load limit curve

## Item description

Subject to changes. Please also observe the further product documentation!

WAGO Kontakttechnik GmbH & Co. KG  
Hansastr. 27  
32423 Minden  
Phone: +49571 887-0 | Fax: +49571 887-169  
Email: [info.de@wago.com](mailto:info.de@wago.com) | Web: [www.wago.com](http://www.wago.com)

Do you have any questions about our products?  
We are always happy to take your call at +49 (571) 887-44222.

**Short description:**

WAGO's 789 Series Switching Relays serve a wide variety of applications, from basic lighting control – homes, hotels and commercial structures – to comprehensive industrial control cabinets. Just 17.5 mm (0.689 inch) wide, the compact DIN-rail-mount enclosure is ideal for distribution boards and meter cabinets.

**Note:**

To protect the relay coils and contacts, inductive loads must be dampened with an effective protection circuit.

**Data****Technical Data****Control circuit**

Nominal input voltage $U_N$	DC 24 V
Input voltage range	-15 ... +10 %
Nominal input current at $U_N$	19 mA

**Load circuit:**

Number of changeover/switchover contacts	1
Contact material (relay)	AgNi 90/10
Limiting continuous current	12 A
Max. make current (resistive)	(AC) 30 A / 4 s
Max. switching voltage	AC 250 V
Max. switching power (resistive)	AC 3000 VA; DC (see load limit curve)
Recommended minimum load	12 V / 10 mA
Pull-in time (typ.)	8 ms
Drop-out time (typ.)	6 ms
Bounce time (typ.)	6 ms
Mechanical life	$3 \times 10^6$ switching operations

**Signaling**

Status indication	Red LED
-------------------	---------

**Safety and protection:**

Rated voltage	250 V
Rated impulse voltage	4 kV

Subject to changes. Please also observe the further product documentation!



Pollution degree	2
Dielectric strength, control/load circuit (AC, 1 min)	5 kVrms
Dielectric strength open contact (AC, 1 min)	1 kVrms
Protection class	IP20

### Connection data

Connection technology	CAGE CLAMP®
Solid conductor	0,2 ... 2,5 mm <sup>2</sup> / 24 ... 14 AWG
Fine-stranded conductor	0,2 ... 2,5 mm <sup>2</sup> / 24 ... 14 AWG
Strip length	9 ... 10 mm / 0.35 ... 0.39 inch

### Geometrical Data

Width	17,5 mm / 0.689 inch
Height from upper-edge of DIN-35 rail	55 mm / 2.165 inch
Depth	90 mm / 3.543 inch

### Mechanical data

Type of mounting	DIN-35 rail
------------------	-------------

### Material Data

Color	gray
Fire load	0.733 MJ
Weight	50.5 g

### Environmental Requirements

Surrounding air (operating) temperature at U <sub>N</sub>	-25 ... 40 °C
Surrounding air (storage) temperature	-40 ... 85 °C
Processing temperature	-25 ... +50 °C

### Standards and specifications

Standards/specifications	EN 60664-1
--------------------------	------------

### Commercial data

Product Group	6 (Interface Electronics)
Packaging type	BOX

Subject to changes. Please also observe the further product documentation!

Country of origin	DE
GTIN	4045454313005
Customs Tariff No.	85364900990

## Counterpart

## Compatible products

### Jumper



**Item no.: 789-112**

Push-in type jumper bar; 12-way; Nominal current 16 A; unplated; silver-colored

[www.wago.com/789-112](http://www.wago.com/789-112)

### Marking accessories



**Item no.: 2009-145**

Mini-WSB Inline; for Smart Printer; 1700 pieces on roll; stretchable 5 - 5.2 mm; plain; snap-on type; white

[www.wago.com/2009-145](http://www.wago.com/2009-145)



**Item no.: 2009-145/000-002**

Mini-WSB Inline; for Smart Printer; 1700 pieces on roll; stretchable 5 - 5.2 mm; plain; snap-on type; white /000-002

[www.wago.com/2009-145](http://www.wago.com/2009-145)



**Item no.: 2009-145/000-005**

Mini-WSB Inline; for Smart Printer; 1700 pieces on roll; stretchable 5 - 5.2 mm; plain; snap-on type; red

[www.wago.com/2009-145](http://www.wago.com/2009-145)

/000-005



**Item no.: 2009-145/000-006**

Mini-WSB Inline; for Smart Printer; 1700 pieces on roll; stretchable 5 - 5.2 mm; plain; snap-on type; blue

[www.wago.com/2009-145](http://www.wago.com/2009-145)

/000-006



**Item no.: 2009-145/000-007**

Mini-WSB Inline; for Smart Printer; 1700 pieces on roll; stretchable 5 - 5.2 mm; plain; snap-on type; white /000-007

[www.wago.com/2009-145](http://www.wago.com/2009-145)

/000-007



**Item no.: 2009-145/000-012**

Mini-WSB Inline; for Smart Printer; 1700 pieces on roll; stretchable 5 - 5.2 mm; plain; snap-on type; orange

[www.wago.com/2009-145](http://www.wago.com/2009-145)

/000-012



**Item no.: 2009-145/000-023**

Mini-WSB Inline; for Smart Printer; 1700 pieces on roll; stretchable 5 - 5.2 mm; plain; snap-on type; green

[www.wago.com/2009-145](http://www.wago.com/2009-145)

/000-023



**Item no.: 2009-145/000-024**

Mini-WSB Inline; for Smart Printer; 1700 pieces on roll; stretchable 5 - 5.2 mm; plain; snap-on type; violet

[www.wago.com/2009-145](http://www.wago.com/2009-145)

/000-024

**Item no.: 210-110**

Fiber-tip pen

[www.wago.com/210-110](http://www.wago.com/210-110)

Subject to changes. Please also observe the further product documentation!

WAGO Kontakttechnik GmbH & Co. KG

Hansastr. 27

32423 Minden















Phone: +49571 887-0 | Fax: +49571 887-169

Email: [info.de@wago.com](mailto:info.de@wago.com) | Web: [www.wago.com](http://www.wago.com)















Do you have any questions about our products?

We are always happy to take your call at +49 (571) 887-44222.



	<b>Item no.: 248-450</b> Mini-WSB marking card; as card; MARKED; K1 - K10 (10x); not stretchable; Horizontal marking; snap-on type; white	<a href="http://www.wago.com/248-450">www.wago.com/248-450</a>
	<b>Item no.: 248-451</b> Mini-WSB marking card; as card; MARKED; K11 - K20 (10x); not stretchable; Horizontal marking; snap-on type; white	<a href="http://www.wago.com/248-451">www.wago.com/248-451</a>
	<b>Item no.: 248-452</b> Mini-WSB marking card; as card; MARKED; K (100x); not stretchable; Horizontal marking; snap-on type; white	<a href="http://www.wago.com/248-452">www.wago.com/248-452</a>
	<b>Item no.: 248-453</b> Mini-WSB marking card; as card; MARKED; U1, ... U10 (10x); not stretchable; Horizontal marking; snap-on type; white	<a href="http://www.wago.com/248-453">www.wago.com/248-453</a>
	<b>Item no.: 248-454</b> Mini-WSB marking card; as card; MARKED; U11 - U20 (10x); not stretchable; Horizontal marking; snap-on type; white	<a href="http://www.wago.com/248-454">www.wago.com/248-454</a>
	<b>Item no.: 248-455</b> Mini-WSB marking card; as card; MARKED; U 100 (10x); not stretchable; Horizontal marking; snap-on type; white	<a href="http://www.wago.com/248-455">www.wago.com/248-455</a>
	<b>Item no.: 248-501</b> Miniature WSB Quick marking system; plain; Marker width 5 mm; 10 strips with 10 markers per card	<a href="http://www.wago.com/248-501">www.wago.com/248-501</a>
	<b>Item no.: 248-501/000-002</b> Mini-WSB marking card; as card; not stretchable; plain; snap-on type; yellow	<a href="http://www.wago.com/248-501/000-002">www.wago.com/248-501/000-002</a>
	<b>Item no.: 248-501/000-005</b> Mini-WSB marking card; as card; not stretchable; plain; snap-on type; red	<a href="http://www.wago.com/248-501/000-005">www.wago.com/248-501/000-005</a>
	<b>Item no.: 248-501/000-006</b> Mini-WSB marking card; as card; not stretchable; plain; snap-on type; blue	<a href="http://www.wago.com/248-501/000-006">www.wago.com/248-501/000-006</a>
	<b>Item no.: 248-501/000-007</b> Mini-WSB marking card; as card; not stretchable; plain; snap-on type; gray	<a href="http://www.wago.com/248-501/000-007">www.wago.com/248-501/000-007</a>
	<b>Item no.: 248-501/000-012</b> Mini-WSB marking card; as card; not stretchable; plain; snap-on type; orange	<a href="http://www.wago.com/248-501/000-012">www.wago.com/248-501/000-012</a>
	<b>Item no.: 248-501/000-017</b> Mini-WSB marking card; as card; not stretchable; plain; snap-on type; light green	<a href="http://www.wago.com/248-501/000-017">www.wago.com/248-501/000-017</a>
	<b>Item no.: 248-501/000-023</b> Mini-WSB marking card; as card; not stretchable; plain; snap-on type; green	<a href="http://www.wago.com/248-501/000-023">www.wago.com/248-501/000-023</a>

Subject to changes. Please also observe the further product documentation!

	<b>Item no.: 248-501/000-024</b> Mini-WSB marking card; as card; not stretchable; plain; snap-on type; violet	<a href="http://www.wago.com/248-501/000-024">www.wago.com/248-501/000-024</a>
	<b>Item no.: 248-502</b> Mini-WSB marking card; as card; MARKED; 1 ... 10 (10x); not stretchable; Horizontal marking; snap-on type; white	<a href="http://www.wago.com/248-502">www.wago.com/248-502</a>
	<b>Item no.: 248-502/000-024</b> Mini-WSB marking card; as card; MARKED; 1 ... 10 (10x); not stretchable; Horizontal marking; snap-on type; violet	<a href="http://www.wago.com/248-502/000-024">www.wago.com/248-502/000-024</a>
	<b>Item no.: 248-503</b> Mini-WSB marking card; as card; MARKED; 11 ... 20 (10x); not stretchable; Horizontal marking; snap-on type; white	<a href="http://www.wago.com/248-503">www.wago.com/248-503</a>
	<b>Item no.: 248-503/000-024</b> Mini-WSB marking card; as card; MARKED; 11 ... 20 (10x); not stretchable; Horizontal marking; snap-on type; violet	<a href="http://www.wago.com/248-503/000-024">www.wago.com/248-503/000-024</a>
	<b>Item no.: 248-504</b> Mini-WSB marking card; as card; MARKED; 21 ... 30 (10x); not stretchable; Horizontal marking; snap-on type; white	<a href="http://www.wago.com/248-504">www.wago.com/248-504</a>
	<b>Item no.: 248-504/000-024</b> Mini-WSB marking card; as card; MARKED; 21 ... 30 (10x); not stretchable; Horizontal marking; snap-on type; violet	<a href="http://www.wago.com/248-504/000-024">www.wago.com/248-504/000-024</a>
	<b>Item no.: 248-505/000-024</b> Mini-WSB marking card; as card; MARKED; 31 ... 40 (10x); not stretchable; Horizontal marking; snap-on type; violet	<a href="http://www.wago.com/248-505/000-024">www.wago.com/248-505/000-024</a>
	<b>Item no.: 248-506</b> Mini-WSB marking card; as card; MARKED; 41 ... 50 (10x); not stretchable; Horizontal marking; snap-on type; white	<a href="http://www.wago.com/248-506">www.wago.com/248-506</a>
	<b>Item no.: 248-566</b> Mini-WSB marking card; as card; MARKED; 1 ... 50 (2x); not stretchable; Horizontal marking; snap-on type; white	<a href="http://www.wago.com/248-566">www.wago.com/248-566</a>
<b>tools</b>		
	<b>Item no.: 210-720</b> Operating tool; Blade: 3.5 x 0.5 mm; with a partially insulated shaft	<a href="http://www.wago.com/210-720">www.wago.com/210-720</a>
<b>ferrule</b>		
	<b>Item no.: 216-241</b> Ferrule; Sleeve for 0.5 mm <sup>2</sup> / 20 AWG; insulated; electro-tin plated; electrolytic copper; gastight crimped; acc. to DIN 46228, Part 4/09.90; white	<a href="http://www.wago.com/216-241">www.wago.com/216-241</a>
	<b>Item no.: 216-242</b> Ferrule; Sleeve for 0.75 mm <sup>2</sup> / 18 AWG; insulated; electro-tin plated; electrolytic copper; gastight crimped; acc. to DIN 46228, Part 4/09.90; gray	<a href="http://www.wago.com/216-242">www.wago.com/216-242</a>
	<b>Item no.: 216-243</b> Ferrule; Sleeve for 1 mm <sup>2</sup> / AWG 18; insulated; electro-tin plated; electrolytic copper; gastight crimped; acc. to DIN 46228, Part 4/09.90; red	<a href="http://www.wago.com/216-243">www.wago.com/216-243</a>
	<b>Item no.: 216-244</b>	

Subject to changes. Please also observe the further product documentation!



Ferrule; Sleeve for 1.5 mm<sup>2</sup> / AWG 16; insulated; electro-tin plated; electrolytic copper; gastight crimped; acc. to DIN 46228, Part 4/09.90; black

[www.wago.com/216-244](http://www.wago.com/216-244)

## Downloads

### Documentation

#### Bid Text

789-304 GAEB X81 - Datei	Feb 19, 2019	xml 4.2 kB	Download
-----------------------------	--------------	---------------	----------

789-304 GAEB docx - Datei	Feb 20, 2019	docx 16.8 kB	Download
------------------------------	--------------	-----------------	----------

#### Instruction Leaflet

		pdf 1.3 MB	Download
--	--	---------------	----------

#### Additional Information

Disposal; Electrical and electronic equipment, Packaging	V 1.0.0	pdf 265.8 kB	Download
--	---------	-----------------	----------

## CAD/CAE-Data

### CAD data

2D/3D Models 789-304		URL	Download
----------------------	--	-----	----------

### CAE data

EPLAN Data Portal 789-304		URL	Download
---------------------------	--	-----	----------

WSCAD Universe 789-304		URL	Download
------------------------	--	-----	----------

## Installation Notes

### Inserting a conductor

Subject to changes. Please also observe the further product documentation!

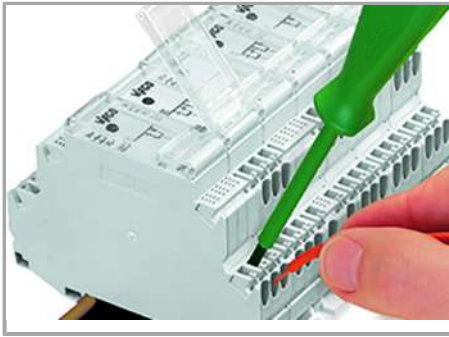

Connection of conductor.

### Jumpered

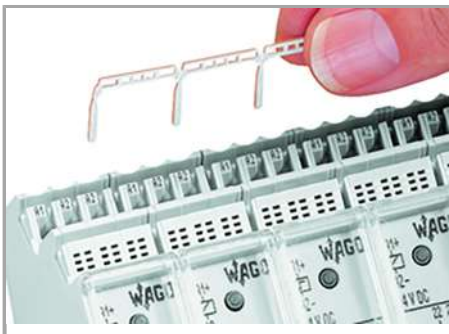

Easy commoning using adjacent jumpers

### Marking

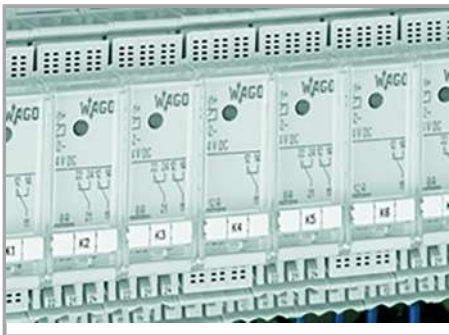

Marking using miniature WSB quick marking card

Subject to changes. Please also observe the further product documentation!