

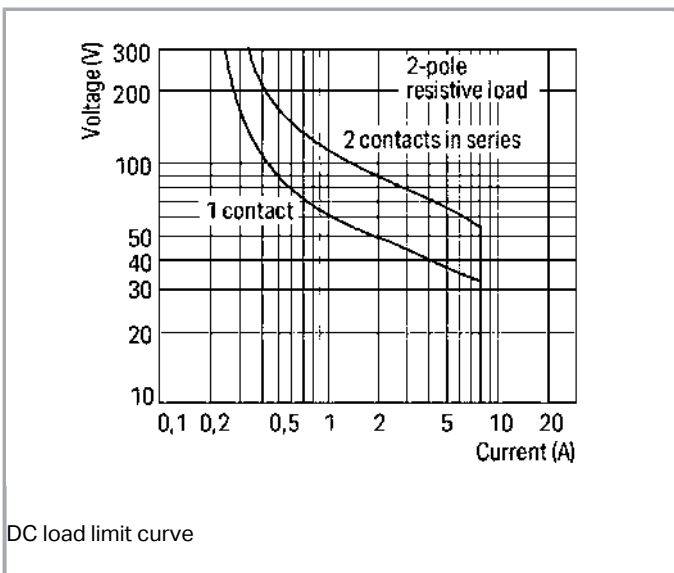

Data sheet | Item number: 789-516

Relay module; for meter cabinet; Relay with 2 changeover contacts (2u); 2,50 mm2; gray

www.wago.com/789-516

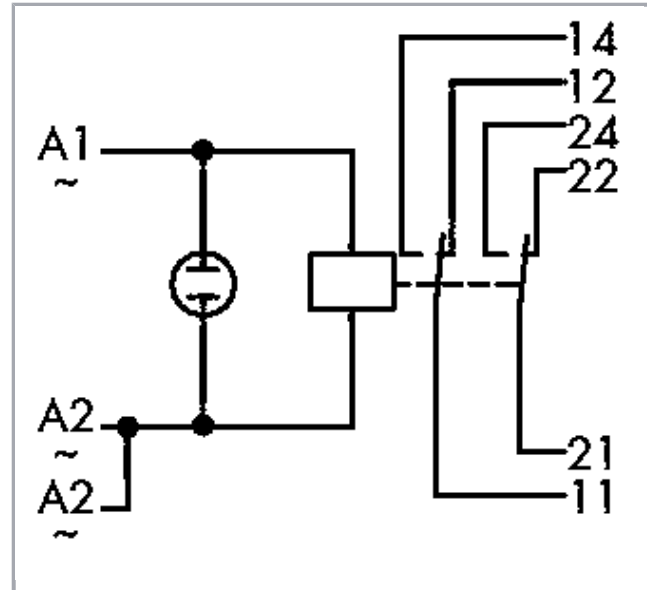

Item description

Subject to changes. Please also observe the further product documentation!

WAGO Kontakttechnik GmbH & Co. KG
Hansastr. 27
32423 Minden
Phone: +49571 887-0 | Fax: +49571 887-169
Email: info.de@wago.com | Web: www.wago.com

Do you have any questions about our products?
We are always happy to take your call at +49 (571) 887-44222.



Data sheet | Item number: 789-516

www.wago.com/789-516

Short description:

WAGO 789 Series switching relays serve a wide variety of applications, from basic lighting control – homes, hotels and commercial structures – to comprehensive industrial control cabinets. Just 17.5mm wide, the compact DIN-rail mount enclosure is ideal for distribution boards and meter cabinets.

Note:

Inductive loads have to be attenuated by an appropriate protective circuit in order to protect relay coils and contacts.

Data

Technical Data

Control circuit

Nominal input voltage U_N	AC 230 V
Input voltage range	-15 ... +10 %
Nominal input current at U_N	4.2 mA

Load circuit:

Limiting continuous current	8 A
Max. make current (resistive)	(AC) 15 A / 4 s
Max. switching voltage	AC 250 V
Max. switching power (resistive)	AC 2,000 VA; DC see load limit curve
Recommended minimum load	12 V / 10 mA
Mechanical life	5×10^6 switching operations

Safety and protection:

Dielectric strength, control/load circuit (AC, 1 min)	5 kVrms
Dielectric strength open contact (AC, 1 min)	1 kVrms

Connection data

Solid conductor	0.08 ... 2.5 mm ² / 28 ... 14 AWG
Fine-stranded conductor	0.08 ... 2.5 mm ² / 28 ... 14 AWG
Strip length	9 ... 10 mm / 0.35 ... 0.39 inch

Subject to changes. Please also observe the further product documentation!

WAGO Kontakttechnik GmbH & Co. KG
Hansastr. 27
32423 Minden
Phone: +49571 887-0 | Fax: +49571 887-169
Email: info.de@wago.com | Web: www.wago.com

Do you have any questions about our products?
We are always happy to take your call at +49 (571) 887-44222.

This item has been discontinued and as of 30.05.2018, can no longer be delivered.



Data sheet | Item number: 789-516

www.wago.com/789-516

Geometrical Data

Width	17.5 mm / 0.689 inch
Height from upper-edge of DIN-35 rail	55 mm / 2.165 inch
Depth	90 mm / 3.543 inch

Material Data

Color	gray
-------	------

Environmental Requirements

Surrounding air (operating) temperature at U_N	-25 ... 40 °C
Surrounding air (storage) temperature	-40 ... 85 °C

Commercial data

Product Group	6 (Interface Electronics)
Packaging type	BOX
Country of origin	DE
Customs Tariff No.	85364900990

Counterpart

Compatible products

tools



Item no.: 210-720

Operating tool; Blade: 3.5 x 0.5 mm; with a partially insulated shaft

www.wago.com/210-720

Marking accessories



Item no.: 2009-145

Mini-WSB Inline; for Smart Printer; 1700 pieces on roll; stretchable 5 - 5.2 mm; plain; snap-on type; white

www.wago.com/2009-145



Item no.: 2009-145/000-002

Mini-WSB Inline; for Smart Printer; 1700 pieces on roll; stretchable 5 - 5.2 mm; plain; snap-on type; white /000-002

www.wago.com/2009-145

Subject to changes. Please also observe the further product documentation!

WAGO Kontakttechnik GmbH & Co. KG

Hansastr. 27

32423 Minden

Phone: +49571 887-0 | Fax: +49571 887-169

Email: info.de@wago.com | Web: www.wago.com

Do you have any questions about our products?













We are always happy to take your call at +49 (571) 887-44222.

This item has been discontinued and as of 30.05.2018, can no longer be delivered.



Data sheet | Item number: 789-516

www.wago.com/789-516

	Item no.: 2009-145/000-005 Mini-WSB Inline; for Smart Printer; 1700 pieces on roll; stretchable 5 - 5.2 mm; plain; snap-on type; red	www.wago.com/2009-145/000-005
	Item no.: 2009-145/000-006 Mini-WSB Inline; for Smart Printer; 1700 pieces on roll; stretchable 5 - 5.2 mm; plain; snap-on type; blue	www.wago.com/2009-145/000-006
	Item no.: 2009-145/000-007 Mini-WSB Inline; for Smart Printer; 1700 pieces on roll; stretchable 5 - 5.2 mm; plain; snap-on type; white	www.wago.com/2009-145/000-007
	Item no.: 2009-145/000-012 Mini-WSB Inline; for Smart Printer; 1700 pieces on roll; stretchable 5 - 5.2 mm; plain; snap-on type; orange	www.wago.com/2009-145/000-012
	Item no.: 2009-145/000-023 Mini-WSB Inline; for Smart Printer; 1700 pieces on roll; stretchable 5 - 5.2 mm; plain; snap-on type; green	www.wago.com/2009-145/000-023
	Item no.: 2009-145/000-024 Mini-WSB Inline; for Smart Printer; 1700 pieces on roll; stretchable 5 - 5.2 mm; plain; snap-on type; violet	www.wago.com/2009-145/000-024
	Item no.: 210-110 Fiber-tip pen	www.wago.com/210-110
	Item no.: 248-450 Mini-WSB marking card; as card; MARKED; K1 - K10 (10x); not stretchable; Horizontal marking; snap-on type; white	www.wago.com/248-450
	Item no.: 248-451 Mini-WSB marking card; as card; MARKED; K11 - K20 (10x); not stretchable; Horizontal marking; snap-on type; white	www.wago.com/248-451
	Item no.: 248-452 Mini-WSB marking card; as card; MARKED; K (100x); not stretchable; Horizontal marking; snap-on type; white	www.wago.com/248-452
	Item no.: 248-453 Mini-WSB marking card; as card; MARKED; U1, ... U10 (10x); not stretchable; Horizontal marking; snap-on type; white	www.wago.com/248-453
	Item no.: 248-454 Mini-WSB marking card; as card; MARKED; U11 - U20 (10x); not stretchable; Horizontal marking; snap-on type; white	www.wago.com/248-454
	Item no.: 248-455 Mini-WSB marking card; as card; MARKED; U 100 (10x); not stretchable; Horizontal marking; snap-on type; white	www.wago.com/248-455
	Item no.: 248-501 Miniature WSB Quick marking system; plain; Marker width 5 mm; 10 strips with 10 markers per card	www.wago.com/248-501
	Item no.: 248-501/000-002 Mini-WSB marking card; as card; not stretchable; plain; snap-on type; yellow	www.wago.com/248-501/000-002

Subject to changes. Please also observe the further product documentation!

WAGO Kontakttechnik GmbH & Co. KG
Hansastr. 27
32423 Minden
Phone: +49571 887-0 | Fax: +49571 887-169
Email: info.de@wago.com | Web: www.wago.com















Do you have any questions about our products?
We are always happy to take your call at +49 (571) 887-44222.

This item has been discontinued and as of 30.05.2018, can no longer be delivered.



Data sheet | Item number: 789-516

www.wago.com/789-516

	Item no.: 248-501/000-005 Mini-WSB marking card; as card; not stretchable; plain; snap-on type; red	www.wago.com/248-501/000-005
	Item no.: 248-501/000-006 Mini-WSB marking card; as card; not stretchable; plain; snap-on type; blue	www.wago.com/248-501/000-006
	Item no.: 248-501/000-007 Mini-WSB marking card; as card; not stretchable; plain; snap-on type; gray	www.wago.com/248-501/000-007
	Item no.: 248-501/000-012 Mini-WSB marking card; as card; not stretchable; plain; snap-on type; orange	www.wago.com/248-501/000-012
	Item no.: 248-501/000-017 Mini-WSB marking card; as card; not stretchable; plain; snap-on type; light green	www.wago.com/248-501/000-017
	Item no.: 248-501/000-023 Mini-WSB marking card; as card; not stretchable; plain; snap-on type; green	www.wago.com/248-501/000-023
	Item no.: 248-501/000-024 Mini-WSB marking card; as card; not stretchable; plain; snap-on type; violet	www.wago.com/248-501/000-024
	Item no.: 248-502 Mini-WSB marking card; as card; MARKED; 1 ... 10 (10x); not stretchable; Horizontal marking; snap-on type; white	www.wago.com/248-502
	Item no.: 248-502/000-024 Mini-WSB marking card; as card; MARKED; 1 ... 10 (10x); not stretchable; Horizontal marking; snap-on type; violet	www.wago.com/248-502/000-024
	Item no.: 248-503 Mini-WSB marking card; as card; MARKED; 11 ... 20 (10x); not stretchable; Horizontal marking; snap-on type; white	www.wago.com/248-503
	Item no.: 248-503/000-024 Mini-WSB marking card; as card; MARKED; 11 ... 20 (10x); not stretchable; Horizontal marking; snap-on type; violet	www.wago.com/248-503/000-024
	Item no.: 248-504 Mini-WSB marking card; as card; MARKED; 21 ... 30 (10x); not stretchable; Horizontal marking; snap-on type; white	www.wago.com/248-504
	Item no.: 248-504/000-024 Mini-WSB marking card; as card; MARKED; 21 ... 30 (10x); not stretchable; Horizontal marking; snap-on type; violet	www.wago.com/248-504/000-024
	Item no.: 248-505/000-024 Mini-WSB marking card; as card; MARKED; 31 ... 40 (10x); not stretchable; Horizontal marking; snap-on type; violet	www.wago.com/248-505/000-024

Subject to changes. Please also observe the further product documentation!

WAGO Kontakttechnik GmbH & Co. KG
Hansastr. 27
32423 Minden
Phone: +49571 887-0 | Fax: +49571 887-169
Email: info.de@wago.com | Web: www.wago.com

Do you have any questions about our products?
We are always happy to take your call at +49 (571) 887-44222.

This item has been discontinued and as of 30.05.2018, can no longer be delivered.



Data sheet | Item number: 789-516

www.wago.com/789-516

type; violet



Item no.: 248-506

Mini-WSB marking card; as card; MARKED; 41 ... 50 (10x); not stretchable; Horizontal marking; snap-on type; white www.wago.com/248-506



Item no.: 248-566

Mini-WSB marking card; as card; MARKED; 1 ... 50 (2x); not stretchable; Horizontal marking; snap-on type; white www.wago.com/248-566

Jumper



Item no.: 789-112

Push-in type jumper bar; 12-way; Nominal current 16 A; unplated; silver-colored www.wago.com/789-112

ferrule



Item no.: 216-241

Ferrule; Sleeve for 0.5 mm² / 20 AWG; insulated; electro-tin plated; electrolytic copper; gastight crimped; acc. to DIN 46228, Part 4/09.90; white www.wago.com/216-241



Item no.: 216-242

Ferrule; Sleeve for 0.75 mm² / 18 AWG; insulated; electro-tin plated; electrolytic copper; gastight crimped; acc. to DIN 46228, Part 4/09.90; gray www.wago.com/216-242



Item no.: 216-243

Ferrule; Sleeve for 1 mm² / AWG 18; insulated; electro-tin plated; electrolytic copper; gastight crimped; acc. to DIN 46228, Part 4/09.90; red www.wago.com/216-243



Item no.: 216-244

Ferrule; Sleeve for 1.5 mm² / AWG 16; insulated; electro-tin plated; electrolytic copper; gastight crimped; acc. to DIN 46228, Part 4/09.90; black www.wago.com/216-244

Downloads

Documentation

Additional Information

Disposal; Electrical and electronic equipment, Packaging	V 1.0.0	pdf 265.8 kB	Download
--	---------	-----------------	----------

CAD/CAE-Data

CAD data

2D/3D Models 789-516	URL	Download
----------------------	-----	----------

Installation Notes

Subject to changes. Please also observe the further product documentation!

WAGO Kontakttechnik GmbH & Co. KG
Hansastr. 27
32423 Minden
Phone: +49571 887-0 | Fax: +49571 887-169
Email: info.de@wago.com | Web: www.wago.com

Do you have any questions about our products?
We are always happy to take your call at +49 (571) 887-44222.