

Data sheet | Item number: 789-536

Relay module; Nominal input voltage: 24 VAC; 2 break and 2 make contacts;
Limiting continuous current: 4 A; for lamp loads; Red status indicator; Module
width: 18 mm; 2,50 mm²; gray



www.wago.com/789-536



Color: ■

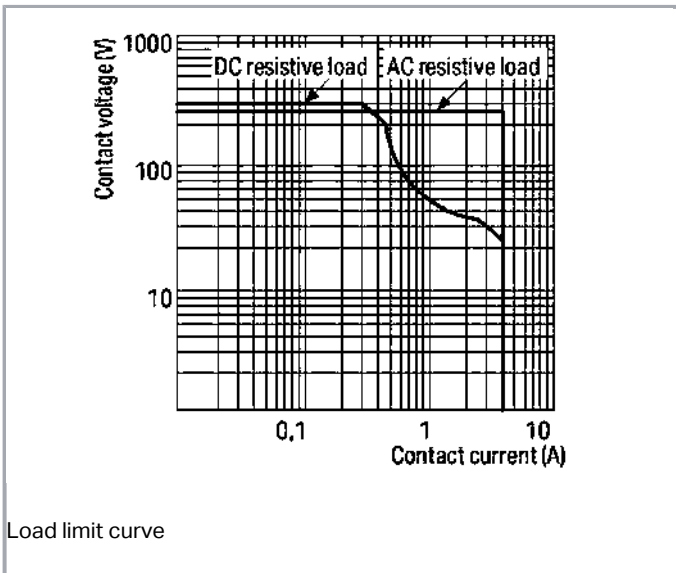
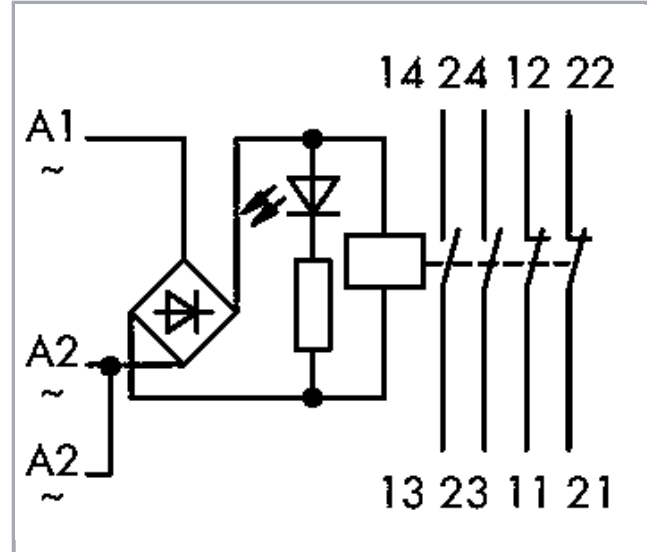

Subject to changes. Please also observe the further product documentation!

WAGO Kontakttechnik GmbH & Co. KG
Hansastr. 27
32423 Minden
Phone: +49571 887-0 | Fax: +49571 887-169
Email: info.de@wago.com | Web: www.wago.com

Do you have any questions about our products?
We are always happy to take your call at +49 (571) 887-44222.



Item description

Short description:

WAGO's 789 Series Switching Relays serve a wide variety of applications, from basic lighting control – homes, hotels and commercial structures – to comprehensive industrial control cabinets. Just 17.5 mm (0.689 inch) wide, the compact DIN-rail-mount enclosure is ideal for distribution boards and meter cabinets.

Note:

To protect the relay coils and contacts, inductive loads must be dampened with an effective protection circuit.

Data

Technical Data

Control circuit

Nominal input voltage U_N	AC/DC 24 V
Input voltage range	-15 ... +10 %
Nominal input current at U_N	12 mA

Load circuit:

Number of break contacts/switch off contacts	2
Number of make contacts/switch on contacts	2
Contact material (relay)	AgNi + Au
Limiting continuous current	4 A
Max. switching voltage	AC 250 V
Max. switching power (resistive)	AC 1000 VA; DC (see load limit curve)
Recommended minimum load	0,1 V / 0,1 mA
Pull-in time (typ.)	20 ms
Drop-out time (typ.)	20 ms
Bounce time (typ.)	1 ms
Mechanical life	10 x 10 ⁶ switching operations

Signaling

Status indication	Red LED
-------------------	---------

Safety and protection:

Rated voltage	230 V
---------------	-------

Subject to changes. Please also observe the further product documentation!



Rated impulse voltage	2.5 kV
Pollution degree	2
Dielectric strength, control/load circuit (AC, 1 min)	1,5 kVrms
Dielectric strength open contact (AC, 1 min)	0,75 kVrms
Dielectric strength, load/load circuit (AC, 1 min)	1 kVrms
Protection class	IP20

Connection data

Connection technology	CAGE CLAMP®
Solid conductor	0,2 ... 2,5 mm ² / 24 ... 14 AWG
Fine-stranded conductor	0,2 ... 2,5 mm ² / 24 ... 14 AWG
Strip length	9 ... 10 mm / 0.35 ... 0.39 inch

Geometrical Data

Width	17,5 mm / 0.689 inch
Height from upper-edge of DIN-35 rail	55 mm / 2.165 inch
Depth	90 mm / 3.543 inch

Mechanical data

Type of mounting	DIN-35 rail
------------------	-------------

Material Data

Color	gray
Fire load	1.033 MJ
Weight	50.7 g

Environmental Requirements

Surrounding air (operating) temperature at U _N	-25 ... 40 °C
Surrounding air (storage) temperature	-40 ... 85 °C
Processing temperature	-25 ... +50 °C

Standards and specifications

Standards/specifications	EN 60664-1; EN 61810-1
--------------------------	------------------------

Subject to changes. Please also observe the further product documentation!

Commercial data

Product Group	6 (Interface Electronics)
Packaging type	BOX
Country of origin	DE
GTIN	4017332814850
Customs Tariff No.	85364900990

Counterpart

Compatible products

tools



Item no.: 210-720

Operating tool; Blade: 3.5 x 0.5 mm; with a partially insulated shaft

www.wago.com/210-720

Jumper



Item no.: 789-112

Push-in type jumper bar; 12-way; Nominal current 16 A; unplated; silver-colored

www.wago.com/789-112

Marking accessories



Item no.: 2009-145

Mini-WSB Inline; for Smart Printer; 1700 pieces on roll; stretchable 5 - 5.2 mm; plain; snap-on type; white

www.wago.com/2009-145



Item no.: 2009-145/000-002

Mini-WSB Inline; for Smart Printer; 1700 pieces on roll; stretchable 5 - 5.2 mm; plain; snap-on type; white /000-002

www.wago.com/2009-145



Item no.: 2009-145/000-005

Mini-WSB Inline; for Smart Printer; 1700 pieces on roll; stretchable 5 - 5.2 mm; plain; snap-on type; red /000-005

www.wago.com/2009-145



Item no.: 2009-145/000-006

Mini-WSB Inline; for Smart Printer; 1700 pieces on roll; stretchable 5 - 5.2 mm; plain; snap-on type; blue /000-006

www.wago.com/2009-145



Item no.: 2009-145/000-007

Mini-WSB Inline; for Smart Printer; 1700 pieces on roll; stretchable 5 - 5.2 mm; plain; snap-on type; white /000-007

www.wago.com/2009-145



Item no.: 2009-145/000-012

Mini-WSB Inline; for Smart Printer; 1700 pieces on roll; stretchable 5 - 5.2 mm; plain; snap-on type; orange

www.wago.com/2009-145

/000-012

Subject to changes. Please also observe the further product documentation!

WAGO Kontakttechnik GmbH & Co. KG

Hansastr. 27















32423 Minden

Phone: +49571 887-0 | Fax: +49571 887-169















Email: info.de@wago.com | Web: www.wago.com

Do you have any questions about our products?

We are always happy to take your call at +49 (571) 887-44222.

	<p>Item no.: 2009-145/000-023 Mini-WSB Inline; for Smart Printer; 1700 pieces on roll; stretchable 5 - 5.2 mm; plain; snap-on type; green</p>	www.wago.com/2009-145/000-023
	<p>Item no.: 2009-145/000-024 Mini-WSB Inline; for Smart Printer; 1700 pieces on roll; stretchable 5 - 5.2 mm; plain; snap-on type; violet</p>	www.wago.com/2009-145/000-024
	<p>Item no.: 210-110 Fiber-tip pen</p>	www.wago.com/210-110
	<p>Item no.: 248-450 Mini-WSB marking card; as card; MARKED; K1 - K10 (10x); not stretchable; Horizontal marking; snap-on type; white</p>	www.wago.com/248-450
	<p>Item no.: 248-451 Mini-WSB marking card; as card; MARKED; K11 - K20 (10x); not stretchable; Horizontal marking; snap-on type; white</p>	www.wago.com/248-451
	<p>Item no.: 248-452 Mini-WSB marking card; as card; MARKED; K (100x); not stretchable; Horizontal marking; snap-on type; white</p>	www.wago.com/248-452
	<p>Item no.: 248-453 Mini-WSB marking card; as card; MARKED; U1, ... U10 (10x); not stretchable; Horizontal marking; snap-on type; white</p>	www.wago.com/248-453
	<p>Item no.: 248-454 Mini-WSB marking card; as card; MARKED; U11 - U20 (10x); not stretchable; Horizontal marking; snap-on type; white</p>	www.wago.com/248-454
	<p>Item no.: 248-455 Mini-WSB marking card; as card; MARKED; U 100 (10x); not stretchable; Horizontal marking; snap-on type; white</p>	www.wago.com/248-455
	<p>Item no.: 248-501 Miniature WSB Quick marking system; plain; Marker width 5 mm; 10 strips with 10 markers per card</p>	www.wago.com/248-501
	<p>Item no.: 248-501/000-002 Mini-WSB marking card; as card; not stretchable; plain; snap-on type; yellow</p>	www.wago.com/248-501/000-002
	<p>Item no.: 248-501/000-005 Mini-WSB marking card; as card; not stretchable; plain; snap-on type; red</p>	www.wago.com/248-501/000-005
	<p>Item no.: 248-501/000-006 Mini-WSB marking card; as card; not stretchable; plain; snap-on type; blue</p>	www.wago.com/248-501/000-006
	<p>Item no.: 248-501/000-007 Mini-WSB marking card; as card; not stretchable; plain; snap-on type; gray</p>	www.wago.com/248-501/000-007
	<p>Item no.: 248-501/000-012 Mini-WSB marking card; as card; not stretchable; plain; snap-on type; orange</p>	www.wago.com/248-501/000-012

Subject to changes. Please also observe the further product documentation!

	Item no.: 248-501/000-017 Mini-WSB marking card; as card; not stretchable; plain; snap-on type; light green	www.wago.com/248-501/000-017
	Item no.: 248-501/000-023 Mini-WSB marking card; as card; not stretchable; plain; snap-on type; green	www.wago.com/248-501/000-023
	Item no.: 248-501/000-024 Mini-WSB marking card; as card; not stretchable; plain; snap-on type; violet	www.wago.com/248-501/000-024
	Item no.: 248-502 Mini-WSB marking card; as card; MARKED; 1 ... 10 (10x); not stretchable; Horizontal marking; snap-on type; white	www.wago.com/248-502
	Item no.: 248-502/000-024 Mini-WSB marking card; as card; MARKED; 1 ... 10 (10x); not stretchable; Horizontal marking; snap-on type; violet	www.wago.com/248-502/000-024
	Item no.: 248-503 Mini-WSB marking card; as card; MARKED; 11 ... 20 (10x); not stretchable; Horizontal marking; snap-on type; white	www.wago.com/248-503
	Item no.: 248-503/000-024 Mini-WSB marking card; as card; MARKED; 11 ... 20 (10x); not stretchable; Horizontal marking; snap-on type; violet	www.wago.com/248-503/000-024
	Item no.: 248-504 Mini-WSB marking card; as card; MARKED; 21 ... 30 (10x); not stretchable; Horizontal marking; snap-on type; white	www.wago.com/248-504
	Item no.: 248-504/000-024 Mini-WSB marking card; as card; MARKED; 21 ... 30 (10x); not stretchable; Horizontal marking; snap-on type; violet	www.wago.com/248-504/000-024
	Item no.: 248-505/000-024 Mini-WSB marking card; as card; MARKED; 31 ... 40 (10x); not stretchable; Horizontal marking; snap-on type; violet	www.wago.com/248-505/000-024
	Item no.: 248-506 Mini-WSB marking card; as card; MARKED; 41 ... 50 (10x); not stretchable; Horizontal marking; snap-on type; white	www.wago.com/248-506
	Item no.: 248-566 Mini-WSB marking card; as card; MARKED; 1 ... 50 (2x); not stretchable; Horizontal marking; snap-on type; white	www.wago.com/248-566
ferrule		
	Item no.: 216-241 Ferrule; Sleeve for 0.5 mm ² / 20 AWG; insulated; electro-tin plated; electrolytic copper; gastight crimped; acc. to DIN 46228, Part 4/09.90; white	www.wago.com/216-241
	Item no.: 216-242 Ferrule; Sleeve for 0.75 mm ² / 18 AWG; insulated; electro-tin plated; electrolytic copper; gastight crimped; acc. to DIN 46228, Part 4/09.90; gray	www.wago.com/216-242

Subject to changes. Please also observe the further product documentation!



Item no.: 216-243

Ferrule; Sleeve for 1 mm² / AWG 18; insulated; electro-tin plated; electrolytic copper; gastight crimped; www.wago.com/216-243
acc. to DIN 46228, Part 4/09.90; red



Item no.: 216-244

Ferrule; Sleeve for 1.5 mm² / AWG 16; insulated; electro-tin plated; electrolytic copper; gastight crimped; acc. to DIN 46228, Part 4/09.90; black www.wago.com/216-244

Downloads

Documentation

Bid Text

789-536 GAEB X81 - Datei	Feb 19, 2019	xml 5.0 kB	Download
-----------------------------	--------------	---------------	----------

789-536 GAEB docx - Datei	Feb 20, 2019	docx 17.5 kB	Download
------------------------------	--------------	-----------------	----------

Instruction Leaflet

		pdf 1.3 MB	Download
--	--	---------------	----------

Additional Information

Disposal; Electrical and electronic equipment, Packaging	V 1.0.0	pdf 265.8 kB	Download
--	---------	-----------------	----------

CAD/CAE-Data

CAD data

2D/3D Models 789-536		URL	Download
----------------------	--	-----	----------

CAE data

EPLAN Data Portal 789-536		URL	Download
---------------------------	--	-----	----------

WSCAD Universe 789-536		URL	Download
------------------------	--	-----	----------

Installation Notes

Inserting a conductor

Subject to changes. Please also observe the further product documentation!

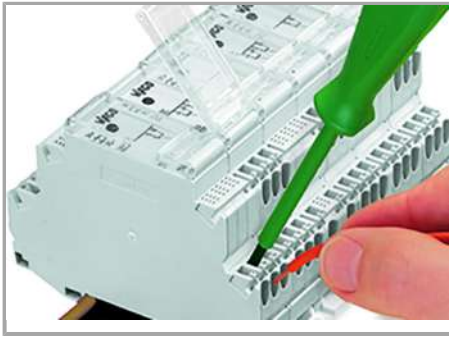

Connection of conductor.

Jumpered

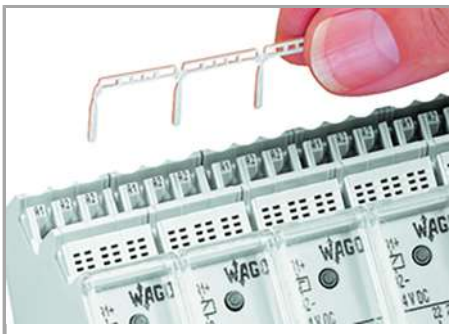

Easy commoning using adjacent jumpers

Marking

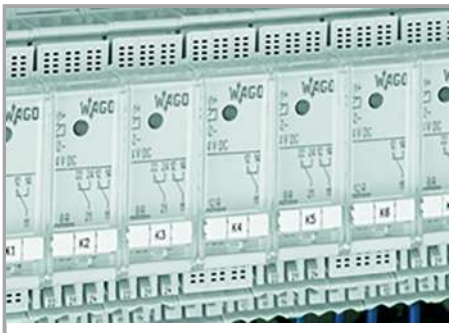

Marking using miniature WSB quick marking card

Subject to changes. Please also observe the further product documentation!