

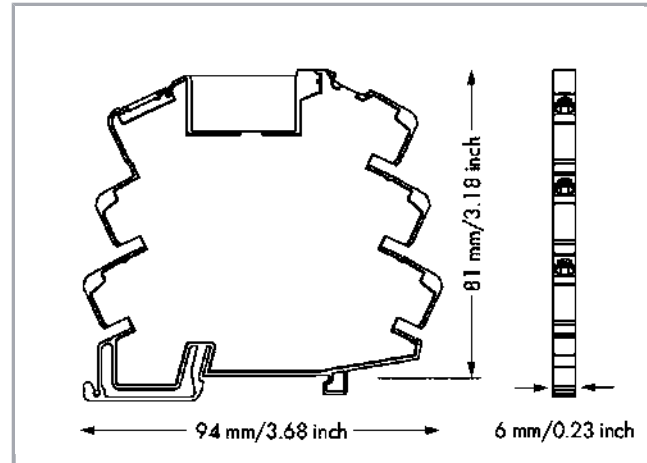

Data sheet | Item number: 857-108

Relay socket; Nominal input voltage: 230 V AC/DC; for 5 mm basic relays;
Yellow status indicator

www.wago.com/857-108

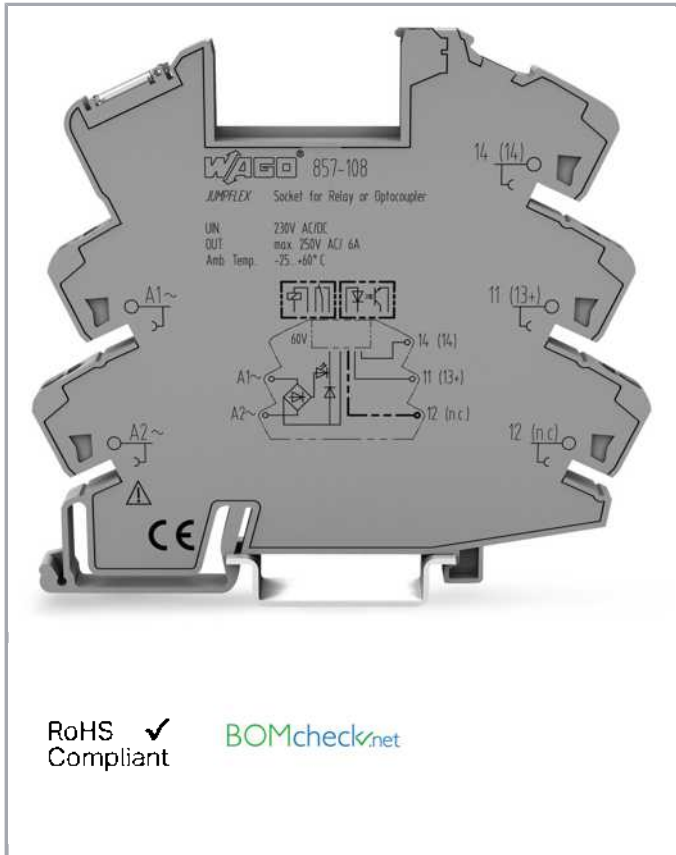

RoHS Compliant

BOMcheck.net

Data

Technical Data

Control circuit

Nominal input voltage U_N

AC/DC 230 V

Load circuit:

Limiting continuous current

6 A

Max. switching voltage

AC 250 V

Subject to changes. Please also observe the further product documentation!

This item has been discontinued and as of 08.07.2019, can no longer be delivered.



Data sheet | Item number: 857-108

www.wago.com/857-108

Signaling

Status indication	Yellow LED
-------------------	------------

Safety and protection:

Protection class	IP20
------------------	------

Connection data

Connection technology	Push-in CAGE CLAMP®
Solid conductor	0,34 ... 2,5 mm ² / 22 ... 14 AWG
Fine-stranded conductor	0,34 ... 2,5 mm ² / 22 ... 14 AWG
Strip length	9 ... 10 mm / 0.35 ... 0.39 inch

Geometrical Data

Width	6 mm / 0.236 inch
Height from upper-edge of DIN-35 rail	81 mm / 3.189 inch
Depth	94 mm / 3.701 inch

Mechanical data

Type of mounting	DIN-35 rail
------------------	-------------

Material Data

Fire load	0.107 MJ
Weight	25.6 g

Environmental Requirements

Surrounding air (operating) temperature at U _N	-40 ... 70 °C
Surrounding air (storage) temperature	-40 ... 70 °C

Standards and specifications

Standards/specifications	EN 61010-2-201; UR
--------------------------	--------------------

Commercial data

Product Group	6 (Interface Electronics)
---------------	---------------------------

Subject to changes. Please also observe the further product documentation!

WAGO Kontakttechnik GmbH & Co. KG
Hansastr. 27
32423 Minden
Phone: +49571 887-0 | Fax: +49571 887-169
Email: info.de@wago.com | Web: www.wago.com

Do you have any questions about our products?
We are always happy to take your call at +49 (571) 887-44222.

This item has been discontinued and as of 08.07.2019, can no longer be delivered.



Data sheet | Item number: 857-108

www.wago.com/857-108

Packaging type	BOX
Country of origin	QU
GTIN	4045454877187
Customs Tariff No.	85366990990

Approvals / Certificates







UL-Approvals

Logo	Approval	Additional Approval Text	Certificate name
	UL Underwriters Laboratories Inc. (ORDINARY LOCATIONS)	UL 508	E175199 Vol.2 Sec. 1

Counterpart

Compatible products

Marking accessories

	Item no.: 2009-110 Marking strips; on reel; not stretchable; plain; snap-on type; white	www.wago.com/2009-110
	Item no.: 2009-115 WMB-Inline; for Smart Printer; 1500 pieces on roll; stretchable 5 - 5.2 mm; plain; snap-on type; white	www.wago.com/2009-115
	Item no.: 2009-115/000-002 WMB-Inline; for Smart Printer; 1500 pieces on roll; stretchable 5 - 5.2 mm; plain; snap-on type; yellow	www.wago.com/2009-115/000-002
	Item no.: 2009-115/000-006 WMB-Inline; for Smart Printer; 1500 pieces on roll; stretchable 5 - 5.2 mm; plain; snap-on type; blue	www.wago.com/2009-115/000-006
	Item no.: 2009-115/000-007 WMB-Inline; for Smart Printer; 1500 pieces on roll; stretchable 5 - 5.2 mm; plain; snap-on type; gray	www.wago.com/2009-115/000-007
	Item no.: 2009-115/000-012 WMB-Inline; for Smart Printer; 1500 pieces on roll; stretchable 5 - 5.2 mm; plain; snap-on type; orange	www.wago.com/2009-115/000-012

Subject to changes. Please also observe the further product documentation!

WAGO Kontakttechnik GmbH & Co. KG
Hansastr. 27
32423 Minden
Phone: +49571 887-0 | Fax: +49571 887-169
Email: info.de@wago.com | Web: www.wago.com















Do you have any questions about our products?
We are always happy to take your call at +49 (571) 887-44222.

This item has been discontinued and as of 08.07.2019, can no longer be delivered.



Data sheet | Item number: 857-108

www.wago.com/857-108

	Item no.: 2009-115/000-017 WMB-Inline; for Smart Printer; 1500 pieces on roll; stretchable 5 - 5.2 mm; plain; snap-on type; light green	www.wago.com/2009-115/000-017
	Item no.: 2009-115/000-023 WMB-Inline; for Smart Printer; 1500 pieces on roll; stretchable 5 - 5.2 mm; plain; snap-on type; green	www.wago.com/2009-115/000-023
	Item no.: 2009-115/000-024 WMB-Inline; for Smart Printer; 1500 pieces on roll; stretchable 5 - 5.2 mm; plain; snap-on type; violet	www.wago.com/2009-115/000-024
	Item no.: 209-128 Adaptor; gray	www.wago.com/209-128
	Item no.: 209-183 Marker card; white	www.wago.com/209-183
	Item no.: 210-110 Fiber-tip pen	www.wago.com/210-110
	Item no.: 249-105 Group marker carrier; gray	www.wago.com/249-105
	Item no.: 793-501 WMB marking card; as card; not stretchable; plain; snap-on type; white	www.wago.com/793-501
	Item no.: 793-501/000-002 WMB marking card; as card; not stretchable; plain; snap-on type; yellow	www.wago.com/793-501/000-002
	Item no.: 793-501/000-005 WMB marking card; as card; not stretchable; plain; snap-on type; red	www.wago.com/793-501/000-005
	Item no.: 793-501/000-006 WMB marking card; as card; not stretchable; plain; snap-on type; blue	www.wago.com/793-501/000-006
	Item no.: 793-501/000-007 WMB marking card; as card; not stretchable; plain; snap-on type; gray	www.wago.com/793-501/000-007
	Item no.: 793-501/000-012 WMB marking card; as card; not stretchable; plain; snap-on type; orange	www.wago.com/793-501/000-012
	Item no.: 793-501/000-017 WMB marking card; as card; not stretchable; plain; snap-on type; light green	www.wago.com/793-501/000-017
	Item no.: 793-501/000-023 WMB marking card; as card; not stretchable; plain; snap-on type; green	www.wago.com/793-501/000-023

Subject to changes. Please also observe the further product documentation!













WAGO Kontakttechnik GmbH & Co. KG
Hansastr. 27
32423 Minden
Phone: +49571 887-0 | Fax: +49571 887-169
Email: info.de@wago.com | Web: www.wago.com

Do you have any questions about our products?
We are always happy to take your call at +49 (571) 887-44222.



Data sheet | Item number: 857-108

www.wago.com/857-108

	Item no.: 793-501/000-024 WMB marking card; as card; not stretchable; plain; snap-on type; violet	www.wago.com/793-501/000-024
	Item no.: 793-502 WMB marking card; as card; MARKED; 1 ... 10 (10x); not stretchable; Horizontal marking; snap-on type; white	www.wago.com/793-502
	Item no.: 793-502/000-002 WMB marking card; as card; MARKED; 1 ... 10 (10x); not stretchable; Horizontal marking; snap-on type; yellow	www.wago.com/793-502/000-002
	Item no.: 793-502/000-005 WMB marking card; as card; MARKED; 1 ... 10 (10x); not stretchable; Horizontal marking; snap-on type; red	www.wago.com/793-502/000-005
	Item no.: 793-502/000-006 WMB marking card; as card; MARKED; 1 ... 10 (10x); not stretchable; Horizontal marking; snap-on type; blue	www.wago.com/793-502/000-006
	Item no.: 793-502/000-007 WMB marking card; as card; MARKED; 1 ... 10 (10x); not stretchable; Horizontal marking; snap-on type; gray	www.wago.com/793-502/000-007
	Item no.: 793-502/000-012 WMB marking card; as card; MARKED; 1 ... 10 (10x); not stretchable; Horizontal marking; snap-on type; orange	www.wago.com/793-502/000-012
	Item no.: 793-502/000-017 WMB marking card; as card; MARKED; 1 ... 10 (10x); not stretchable; Horizontal marking; snap-on type; light green	www.wago.com/793-502/000-017
	Item no.: 793-502/000-023 WMB marking card; as card; MARKED; 1 ... 10 (10x); not stretchable; Horizontal marking; snap-on type; green	www.wago.com/793-502/000-023
	Item no.: 793-502/000-024 WMB marking card; as card; MARKED; 1 ... 10 (10x); not stretchable; Horizontal marking; snap-on type; violet	www.wago.com/793-502/000-024
	Item no.: 793-503 WMB marking card; as card; MARKED; 11 ... 20 (10x); not stretchable; Horizontal marking; snap-on type; white	www.wago.com/793-503
	Item no.: 793-503/000-002 WMB marking card; as card; MARKED; 11 ... 20 (10x); not stretchable; Horizontal marking; snap-on type; yellow	www.wago.com/793-503/000-002
	Item no.: 793-503/000-005 WMB marking card; as card; MARKED; 11 ... 20 (10x); not stretchable; Horizontal marking; snap-on type; red	www.wago.com/793-503/000-005
	Item no.: 793-503/000-006	

Subject to changes. Please also observe the further product documentation!

This item has been discontinued and as of 08.07.2019, can no longer be delivered.



Data sheet | Item number: 857-108

www.wago.com/857-108



WMB marking card; as card; MARKED; 11 ... 20 (10x); not stretchable; Horizontal marking; snap-on type; blue

www.wago.com/793-503/000-006



Item no.: 793-503/000-007

WMB marking card; as card; MARKED; 11 ... 20 (10x); not stretchable; Horizontal marking; snap-on type; gray

www.wago.com/793-503/000-007



Item no.: 793-503/000-012

WMB marking card; as card; MARKED; 11 ... 20 (10x); not stretchable; Horizontal marking; snap-on type; orange

www.wago.com/793-503/000-012



Item no.: 793-503/000-017

WMB marking card; as card; MARKED; 11 ... 20 (10x); not stretchable; Horizontal marking; snap-on type; light green

www.wago.com/793-503/000-017



Item no.: 793-503/000-023

WMB marking card; as card; MARKED; 11 ... 20 (10x); not stretchable; Horizontal marking; snap-on type; green

www.wago.com/793-503/000-023



Item no.: 793-503/000-024

WMB marking card; as card; MARKED; 11 ... 20 (10x); not stretchable; Horizontal marking; snap-on type; violet

www.wago.com/793-503/000-024



Item no.: 793-504

WMB marking card; as card; MARKED; 21 ... 30 (10x); not stretchable; Horizontal marking; snap-on type; white

www.wago.com/793-504



Item no.: 793-504/000-002

WMB marking card; as card; MARKED; 21 ... 30 (10x); not stretchable; Horizontal marking; snap-on type; yellow

www.wago.com/793-504/000-002



Item no.: 793-504/000-005

WMB marking card; as card; MARKED; 21 ... 30 (10x); not stretchable; Horizontal marking; snap-on type; red

www.wago.com/793-504/000-005



Item no.: 793-504/000-006

WMB marking card; as card; MARKED; 21 ... 30 (10x); not stretchable; Horizontal marking; snap-on type; blue

www.wago.com/793-504/000-006



Item no.: 793-504/000-012

WMB marking card; as card; MARKED; 21 ... 30 (10x); not stretchable; Horizontal marking; snap-on type; orange

www.wago.com/793-504/000-012



Item no.: 793-504/000-017

WMB marking card; as card; MARKED; 21 ... 30 (10x); not stretchable; Horizontal marking; snap-on type; light green

www.wago.com/793-504/000-017



Item no.: 793-504/000-023

WMB marking card; as card; MARKED; 21 ... 30 (10x); not stretchable; Horizontal marking; snap-on type; green

www.wago.com/793-504/000-023

Item no.: 793-505

WMB marking card; as card; MARKED; 31 ... 40 (10x); not stretchable; Horizontal marking; snap-on type;

www.wago.com/793-505

Subject to changes. Please also observe the further product documentation!

WAGO Kontakttechnik GmbH & Co. KG

Hansastr. 27

32423 Minden

Phone: +49571 887-0 | Fax: +49571 887-169

Email: info.de@wago.com | Web: www.wago.com

Do you have any questions about our products?

We are always happy to take your call at +49 (571) 887-44222.

This item has been discontinued and as of 08.07.2019, can no longer be delivered.





Data sheet | Item number: 857-108

www.wago.com/857-108

white





 **Item no.: 793-505/000-005**
WMB marking card; as card; MARKED; 31 ... 40 (10x); not stretchable; Horizontal marking; snap-on type; red www.wago.com/793-505/000-005

 **Item no.: 793-505/000-006**
WMB marking card; as card; MARKED; 31 ... 40 (10x); not stretchable; Horizontal marking; snap-on type; blue www.wago.com/793-505/000-006

 **Item no.: 793-505/000-007**
WMB marking card; as card; MARKED; 31 ... 40 (10x); not stretchable; Horizontal marking; snap-on type; gray www.wago.com/793-505/000-007

 **Item no.: 793-505/000-012**
WMB marking card; as card; MARKED; 31 ... 40 (10x); not stretchable; Horizontal marking; snap-on type; orange www.wago.com/793-505/000-012

 **Item no.: 793-506**
WMB marking card; as card; MARKED; 41 ... 50 (10x); not stretchable; Horizontal marking; snap-on type; white www.wago.com/793-506

 **Item no.: 793-506/000-005**
WMB marking card; as card; MARKED; 41 ... 50 (10x); not stretchable; Horizontal marking; snap-on type; red www.wago.com/793-506/000-005

 **Item no.: 793-506/000-006**
WMB marking card; as card; MARKED; 41 ... 50 (10x); not stretchable; Horizontal marking; snap-on type; blue www.wago.com/793-506/000-006

 **Item no.: 793-506/000-012**
WMB marking card; as card; MARKED; 41 ... 50 (10x); not stretchable; Horizontal marking; snap-on type; orange www.wago.com/793-506/000-012

 **Item no.: 793-506/000-017**
WMB marking card; as card; MARKED; 41 ... 50 (10x); not stretchable; Horizontal marking; snap-on type; light green www.wago.com/793-506/000-017

 **Item no.: 793-5501**
WMB marking card; as card; for terminal block width 5 - 17.5 mm; stretchable 5 - 5.2 mm; plain; snap-on type; white www.wago.com/793-5501

 **Item no.: 793-5501/000-002**
WMB marking card; as card; for terminal block width 5 - 17.5 mm; stretchable 5 - 5.2 mm; plain; snap-on type; yellow www.wago.com/793-5501/000-002

 **Item no.: 793-5501/000-005**
WMB marking card; as card; for terminal block width 5 - 17.5 mm; stretchable 5 - 5.2 mm; plain; snap-on type; red www.wago.com/793-5501/000-005

 **Item no.: 793-5501/000-006**
WMB marking card; as card; for terminal block width 5 - 17.5 mm; stretchable 5 - 5.2 mm; plain; snap-on type; blue www.wago.com/793-5501/000-006

Subject to changes. Please also observe the further product documentation!

WAGO Kontakttechnik GmbH & Co. KG
Hansastr. 27
32423 Minden
Phone: +49571 887-0 | Fax: +49571 887-169
Email: info.de@wago.com | Web: www.wago.com













Do you have any questions about our products?
We are always happy to take your call at +49 (571) 887-44222.

This item has been discontinued and as of 08.07.2019, can no longer be delivered.



Data sheet | Item number: 857-108

www.wago.com/857-108

	Item no.: 793-5501/000-007 WMB marking card; as card; for terminal block width 5 - 17.5 mm; stretchable 5 - 5.2 mm; plain; snap-on type; gray	www.wago.com/793-5501/000-007
	Item no.: 793-5501/000-012 WMB marking card; as card; for terminal block width 5 - 17.5 mm; stretchable 5 - 5.2 mm; plain; snap-on type; orange	www.wago.com/793-5501/000-012
	Item no.: 793-5501/000-014 WMB marking card; as card; for terminal block width 5 - 17.5 mm; stretchable 5 - 5.2 mm; plain; snap-on type; brown	www.wago.com/793-5501/000-014
	Item no.: 793-5501/000-017 WMB marking card; as card; for terminal block width 5 - 17.5 mm; stretchable 5 - 5.2 mm; plain; snap-on type; green	www.wago.com/793-5501/000-017
	Item no.: 793-5501/000-023 WMB marking card; as card; for terminal block width 5 - 17.5 mm; stretchable 5 - 5.2 mm; plain; snap-on type; light green	www.wago.com/793-5501/000-023
	Item no.: 793-5501/000-024 WMB marking card; as card; for terminal block width 5 - 17.5 mm; stretchable 5 - 5.2 mm; plain; snap-on type; violet	www.wago.com/793-5501/000-024
	Item no.: 793-566 WMB marking card; as card; MARKED; 1 ... 50 (2x); not stretchable; Horizontal marking; snap-on type; white	www.wago.com/793-566
	Item no.: 793-566/000-002 WMB marking card; as card; MARKED; 1 ... 50 (2x); not stretchable; Horizontal marking; snap-on type; yellow	www.wago.com/793-566/000-002
	Item no.: 793-566/000-005 WMB marking card; as card; MARKED; 1 ... 50 (2x); not stretchable; Horizontal marking; snap-on type; red	www.wago.com/793-566/000-005
	Item no.: 793-566/000-006 WMB marking card; as card; MARKED; 1 ... 50 (2x); not stretchable; Horizontal marking; snap-on type; blue	www.wago.com/793-566/000-006
	Item no.: 793-566/000-007 WMB marking card; as card; MARKED; 1 ... 50 (2x); not stretchable; Horizontal marking; snap-on type; gray	www.wago.com/793-566/000-007
	Item no.: 793-566/000-012 WMB marking card; as card; MARKED; 1 ... 50 (2x); not stretchable; Horizontal marking; snap-on type; orange	www.wago.com/793-566/000-012
	Item no.: 793-566/000-017 WMB marking card; as card; MARKED; 1 ... 50 (2x); not stretchable; Horizontal marking; snap-on type; light green	www.wago.com/793-566/000-017

Item no.: 793-566/000-023

Subject to changes. Please also observe the further product documentation!

WAGO Kontakttechnik GmbH & Co. KG
Hansastr. 27
32423 Minden
Phone: +49571 887-0 | Fax: +49571 887-169
Email: info.de@wago.com | Web: www.wago.com

Do you have any questions about our products?
We are always happy to take your call at +49 (571) 887-44222.

This item has been discontinued and as of 08.07.2019, can no longer be delivered.



Data sheet | Item number: 857-108

www.wago.com/857-108



WMB marking card; as card; MARKED; 1 ... 50 (2x); not stretchable; Horizontal marking; snap-on type; green

www.wago.com/793-566/000-023



Item no.: 793-566/000-024

WMB marking card; as card; MARKED; 1 ... 50 (2x); not stretchable; Horizontal marking; snap-on type; violet

www.wago.com/793-566/000-024

General accessories



Item no.: 209-184

Protection cover; transparent

www.wago.com/209-184



Item no.: 857-155

Basic relay; Nominal input voltage: 60 VDC; 1 changeover contact; Limiting continuous current: 6 A; Module width: 5 mm; Module height: 15 mm

www.wago.com/857-155



Item no.: 857-157

Basic relay; Nominal input voltage: 60 VDC; 1 changeover contact; Limiting continuous current: 6 A; with gold contacts; Module width: 5 mm; Module height: 15 mm

www.wago.com/857-157



Item no.: 857-162

Basic solid-state relay; Nominal input voltage: 60 VDC; Output voltage range: 0 ... 24 VDC; Limiting continuous current: 3 A

www.wago.com/857-162



Item no.: 857-165

Basic solid-state relay; Nominal input voltage: 60 VDC; Output voltage range: 0 ... 48 VDC

www.wago.com/857-165



Item no.: 857-168

Basic solid-state relay; Nominal input voltage: 60 VDC; Output voltage range: 24 ... 240 VAC; Limiting continuous current: 2 A

www.wago.com/857-168

tools



Item no.: 210-720

Operating tool; Blade: 3.5 x 0.5 mm; with a partially insulated shaft

www.wago.com/210-720

Jumper



Item no.: 281-482

Comb-style jumper bar; insulated; 2-way; IN = IN terminal block; gray

www.wago.com/281-482



Item no.: 859-402

Push-in type jumper bar; 2-way; Nominal current 18 A; insulated; light gray

www.wago.com/859-402



Item no.: 859-402/000-005

Push-in type jumper bar; 2-way; Nominal current 18 A; insulated; red

www.wago.com/859-402/000-005



Item no.: 859-402/000-006

Push-in type jumper bar; 2-way; Nominal current 18 A; insulated; blue

www.wago.com/859-402/000-006



Item no.: 859-402/000-029

Push-in type jumper bar; 2-way; Nominal current 18 A; insulated; yellow

www.wago.com/859-402/000-029

Item no.: 859-403

Subject to changes. Please also observe the further product documentation!

WAGO Kontakttechnik GmbH & Co. KG

Hansastr. 27

32423 Minden

Phone: +49571 887-0 | Fax: +49571 887-169

Email: info.de@wago.com | Web: www.wago.com

Do you have any questions about our products?















We are always happy to take your call at +49 (571) 887-44222.

This item has been discontinued and as of 08.07.2019, can no longer be delivered.



Data sheet | Item number: 857-108

www.wago.com/857-108

	Push-in type jumper bar; 3-way; Nominal current 18 A; insulated; light gray	www.wago.com/859-403
	Item no.: 859-403/000-005 Push-in type jumper bar; 3-way; Nominal current 18 A; insulated; red	www.wago.com/859-403/000-005
	Item no.: 859-403/000-006 Push-in type jumper bar; 3-way; Nominal current 18 A; insulated; blue	www.wago.com/859-403/000-006
	Item no.: 859-403/000-029 Push-in type jumper bar; 3-way; Nominal current 18 A; insulated; yellow	www.wago.com/859-403/000-029
	Item no.: 859-404 Push-in type jumper bar; 4-way; Nominal current 18 A; insulated; light gray	www.wago.com/859-404
	Item no.: 859-404/000-005 Push-in type jumper bar; 4-way; Nominal current 18 A; insulated; red	www.wago.com/859-404/000-005
	Item no.: 859-404/000-006 Push-in type jumper bar; 4-way; Nominal current 18 A; insulated; blue	www.wago.com/859-404/000-006
	Item no.: 859-404/000-029 Push-in type jumper bar; 4-way; Nominal current 18 A; insulated; yellow	www.wago.com/859-404/000-029
	Item no.: 859-405 Push-in type jumper bar; 5-way; Nominal current 18 A; insulated; light gray	www.wago.com/859-405
	Item no.: 859-405/000-005 Push-in type jumper bar; 5-way; Nominal current 18 A; insulated; red	www.wago.com/859-405/000-005
	Item no.: 859-405/000-006 Push-in type jumper bar; 5-way; Nominal current 18 A; insulated; blue	www.wago.com/859-405/000-006
	Item no.: 859-405/000-029 Push-in type jumper bar; 5-way; Nominal current 18 A; insulated; yellow	www.wago.com/859-405/000-029
	Item no.: 859-406 Push-in type jumper bar; 6-way; Nominal current 18 A; insulated; light gray	www.wago.com/859-406
	Item no.: 859-406/000-005 Push-in type jumper bar; 6-way; Nominal current 18 A; insulated; red	www.wago.com/859-406/000-005

Subject to changes. Please also observe the further product documentation!

WAGO Kontakttechnik GmbH & Co. KG
Hansastr. 27
32423 Minden
Phone: +49571 887-0 | Fax: +49571 887-169
Email: info.de@wago.com | Web: www.wago.com















Do you have any questions about our products?
We are always happy to take your call at +49 (571) 887-44222.

This item has been discontinued and as of 08.07.2019, can no longer be delivered.



Data sheet | Item number: 857-108

www.wago.com/857-108

	Item no.: 859-406/000-006 Push-in type jumper bar; 6-way; Nominal current 18 A; insulated; blue	www.wago.com/859-406/000-006
	Item no.: 859-406/000-029 Push-in type jumper bar; 6-way; Nominal current 18 A; insulated; yellow	www.wago.com/859-406/000-029
	Item no.: 859-407 Push-in type jumper bar; 7-way; Nominal current 18 A; insulated; light gray	www.wago.com/859-407
	Item no.: 859-407/000-005 Push-in type jumper bar; 7-way; Nominal current 18 A; insulated; red	www.wago.com/859-407/000-005
	Item no.: 859-407/000-006 Push-in type jumper bar; 7-way; Nominal current 18 A; insulated; blue	www.wago.com/859-407/000-006
	Item no.: 859-407/000-029 Push-in type jumper bar; 7-way; Nominal current 18 A; insulated; yellow	www.wago.com/859-407/000-029
	Item no.: 859-408 Push-in type jumper bar; 8-way; Nominal current 18 A; insulated; light gray	www.wago.com/859-408
	Item no.: 859-408/000-005 Push-in type jumper bar; 8-way; Nominal current 18 A; insulated; red	www.wago.com/859-408/000-005
	Item no.: 859-408/000-006 Push-in type jumper bar; 8-way; Nominal current 18 A; insulated; blue	www.wago.com/859-408/000-006
	Item no.: 859-408/000-029 Push-in type jumper bar; 8-way; Nominal current 18 A; insulated; yellow	www.wago.com/859-408/000-029
	Item no.: 859-409 Push-in type jumper bar; 9-way; Nominal current 18 A; insulated; light gray	www.wago.com/859-409
	Item no.: 859-409/000-005 Push-in type jumper bar; 9-way; Nominal current 18 A; insulated; red	www.wago.com/859-409/000-005
	Item no.: 859-409/000-006 Push-in type jumper bar; 9-way; Nominal current 18 A; insulated; blue	www.wago.com/859-409/000-006
	Item no.: 859-409/000-029 Push-in type jumper bar; 9-way; Nominal current 18 A; insulated; yellow	www.wago.com/859-409/000-029

Subject to changes. Please also observe the further product documentation!

WAGO Kontakttechnik GmbH & Co. KG
Hansastr. 27
32423 Minden
Phone: +49571 887-0 | Fax: +49571 887-169
Email: info.de@wago.com | Web: www.wago.com

Do you have any questions about our products?
We are always happy to take your call at +49 (571) 887-44222.

This item has been discontinued and as of 08.07.2019, can no longer be delivered.



Data sheet | Item number: 857-108

www.wago.com/857-108



Item no.: 859-410

Push-in type jumper bar; 10-way; Nominal current 18 A; insulated; light gray

www.wago.com/859-410



Item no.: 859-410/000-005

Push-in type jumper bar; 10-way; Nominal current 18 A; insulated; red

www.wago.com/859-410/000-005



Item no.: 859-410/000-006

Push-in type jumper bar; 10-way; Nominal current 18 A; insulated; blue

www.wago.com/859-410/000-006



Item no.: 859-410/000-029

Push-in type jumper bar; 10-way; Nominal current 18 A; insulated; yellow

www.wago.com/859-410/000-029

ferrule



Item no.: 216-241

Ferrule; Sleeve for 0.5 mm² / 20 AWG; insulated; electro-tin plated; electrolytic copper; gastight crimped; acc. to DIN 46228, Part 4/09.90; white

www.wago.com/216-241



Item no.: 216-242

Ferrule; Sleeve for 0.75 mm² / 18 AWG; insulated; electro-tin plated; electrolytic copper; gastight crimped; acc. to DIN 46228, Part 4/09.90; gray

www.wago.com/216-242



Item no.: 216-243

Ferrule; Sleeve for 1 mm² / AWG 18; insulated; electro-tin plated; electrolytic copper; gastight crimped; acc. to DIN 46228, Part 4/09.90; red

www.wago.com/216-243



Item no.: 216-244

Ferrule; Sleeve for 1.5 mm² / AWG 16; insulated; electro-tin plated; electrolytic copper; gastight crimped; acc. to DIN 46228, Part 4/09.90; black

www.wago.com/216-244

Downloads

Documentation

Instruction Leaflet

Relaisbaustein für Kleinschaltrelais und Optokoppler
Eingangsnennspannung DC 12 V

pdf
2.4 MB
Download

Elektromechanical and Solid-State Relays/Optocouplers

V 1.4.0
Oct 15, 2019

pdf
2.4 MB
Download

Additional Information

Disposal; Electrical and electronic equipment, Packaging

V 1.0.0

pdf
265.8 kB
Download

CAD/CAE-Data

CAD data

Subject to changes. Please also observe the further product documentation!

WAGO Kontakttechnik GmbH & Co. KG

Hansastr. 27

32423 Minden

Phone: +49571 887-0 | Fax: +49571 887-169

Email: info.de@wago.com | Web: www.wago.com

Do you have any questions about our products?

We are always happy to take your call at +49 (571) 887-44222.

This item has been discontinued and as of 08.07.2019, can no longer be delivered.



Data sheet | Item number: 857-108

www.wago.com/857-108

	URL	Download
2D/3D Models 857-108		
CAE data		
EPLAN Data Portal 857-108	URL	Download
WSCAD Universe 857-108	URL	Download

Installation Notes

Subject to changes. Please also observe the further product documentation!

WAGO Kontakttechnik GmbH & Co. KG
Hansastr. 27
32423 Minden
Phone: +49571 887-0 | Fax: +49571 887-169
Email: info.de@wago.com | Web: www.wago.com

Do you have any questions about our products?
We are always happy to take your call at +49 (571) 887-44222.