

This item has been discontinued and as of 08.07.2019, can no longer be delivered.



Data sheet | Item number: 857-306

Relay module; Nominal input voltage: 60 VDC; 1 changeover contact;

Limiting continuous current: 6 A; Yellow status indicator; Module width: 6 mm

www.wago.com/857-306

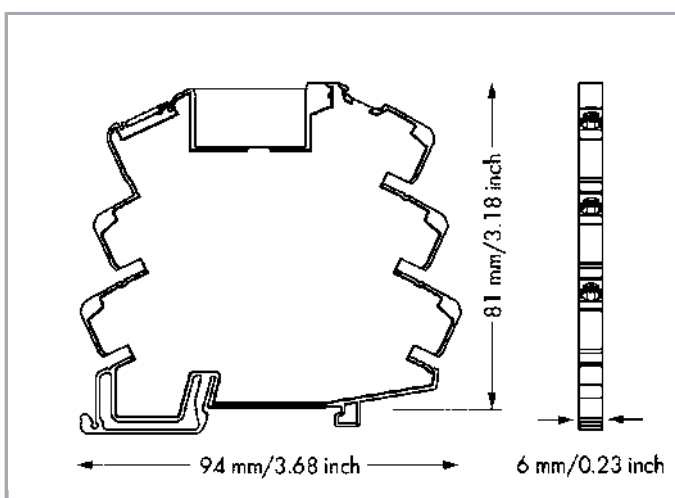
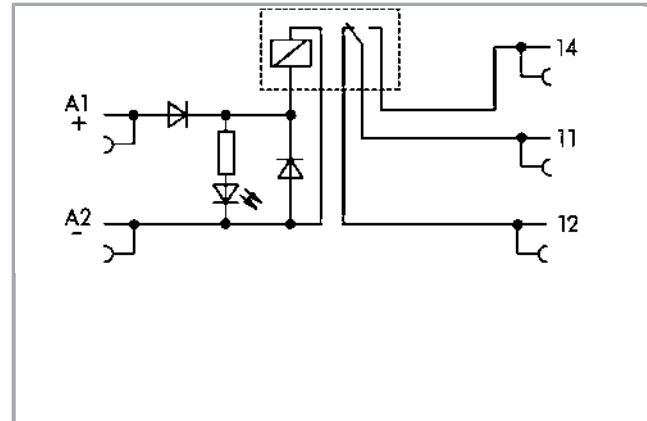
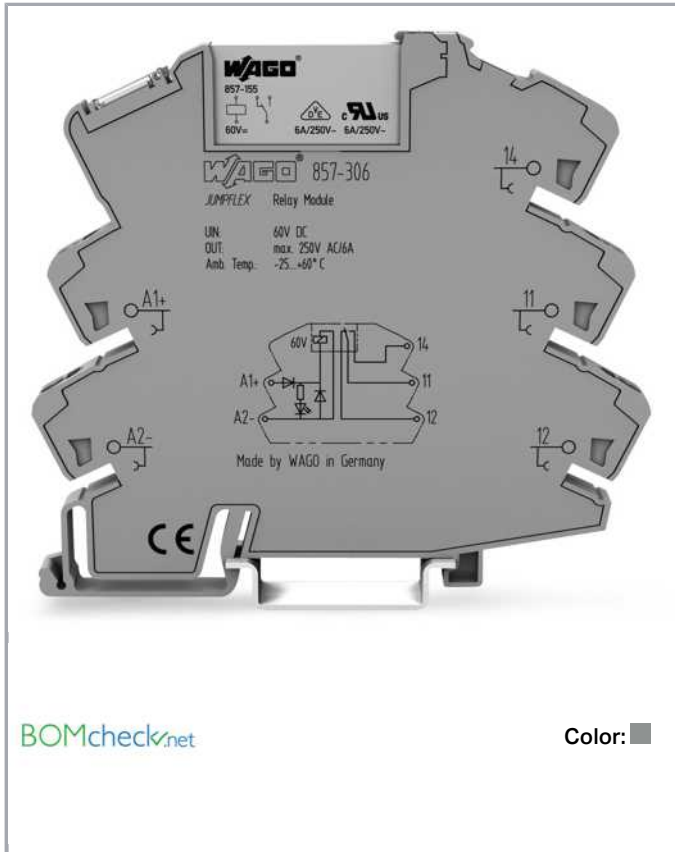

Subject to changes. Please also observe the further product documentation!

WAGO Kontakttechnik GmbH & Co. KG
Hansastr. 27
32423 Minden
Phone: +49571 887-0 | Fax: +49571 887-169
Email: info.de@wago.com | Web: www.wago.com

Do you have any questions about our products?
We are always happy to take your call at +49 (571) 887-44222.



Data sheet | Item number: 857-306

www.wago.com/857-306

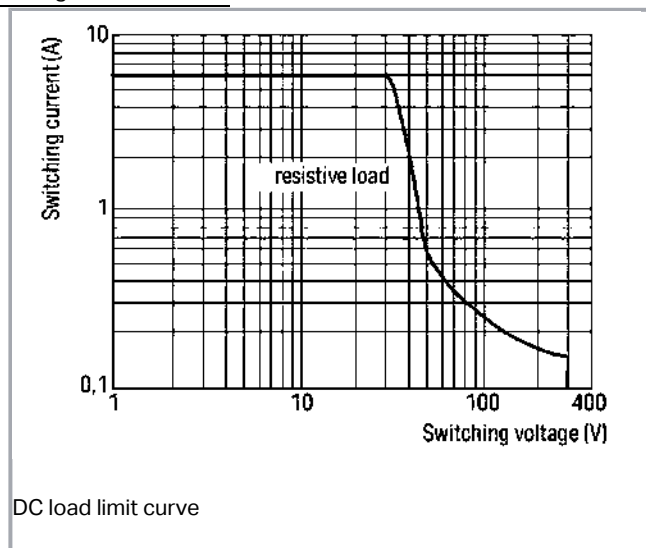

Item description

Short description:

Relay modules with replaceable miniature switching relays for electrical isolation of sensor/actuator level and control/PLC.

The switch status is indicated by an integrated yellow LED.

The device can be labeled using the WAGO WMB Multi marking system.

Note:

Inductive loads have to be attenuated by an appropriate protective circuit in order to protect relay coils and contacts.

Data

Technical Data

Control circuit

Nominal input voltage U_N	DC 60 V
Input voltage range	-15 ... +20 %
Nominal input current at U_N	5.2 mA

Load circuit:

Number of changeover/switchover contacts	1
Contact material (relay)	AgSnO ₂
Limiting continuous current	6 A

Subject to changes. Please also observe the further product documentation!

This item has been discontinued and as of 08.07.2019, can no longer be delivered.



Data sheet | Item number: 857-306

www.wago.com/857-306

Max. make current (resistive)	(AC) 20 A / 0.02 s
Max. switching voltage	AC 250 V
Max. switching power (resistive)	AC 1,500 VA; DC see load limit curve
Switching capacity	AC-15: 3 A / AC 250 V; DC-13: 2 A / DC 24 V
Recommended minimum load	10 V / 10 mA; 24 V / 1 mA
Pull-in time (typ.)	8 ms
Drop-out time (typ.)	8 ms
Bounce time (typ)	3.5 ms
Electrical life (N.O.; resistive load; 23 °C)	50 x 10 ³ switching operations
Mechanical life	5 x 10 ⁶ switching operations
Max. switching load with load/without load	6 min ⁻¹ / 180 min ⁻¹

Signaling

Status indication	LED yellow
-------------------	------------

Safety and protection:

Rated voltage	250 V
Rated impulse voltage	4 kV
Pollution degree	2
Dielectric strength, control/load circuit (AC, 1 min)	4 kVrms
Dielectric strength open contact (AC, 1 min)	1 kVrms
Protection class	IP20

Connection data

Solid conductor	0.34 ... 2.5 mm ² / 22 ... 14 AWG
Fine-stranded conductor	0.34 ... 2.5 mm ² / 22 ... 14 AWG
Strip length	9 ... 10 mm / 0.35 ... 0.39 inch

Geometrical Data

Width	6 mm / 0.236 inch
Height from upper-edge of DIN-35 rail	81 mm / 3.189 inch
Depth	94 mm / 3.701 inch

Mechanical data

Type of mounting	DIN-35 rail
------------------	-------------

Subject to changes. Please also observe the further product documentation!

WAGO Kontakttechnik GmbH & Co. KG
Hansastr. 27
32423 Minden
Phone: +49571 887-0 | Fax: +49571 887-169
Email: info.de@wago.com | Web: www.wago.com

Do you have any questions about our products?
We are always happy to take your call at +49 (571) 887-44222.

This item has been discontinued and as of 08.07.2019, can no longer be delivered.



Data sheet | Item number: 857-306

www.wago.com/857-306

Material Data

Color	gray
Weight	31 g

Environmental Requirements

Surrounding air (operating) temperature at U_N	-40 ... 60 °C
Surrounding air (storage) temperature	-40 ... 70 °C
Processing temperature	-25 ... +50 °C

Standards and specifications

Standards/specifications	EN 61010-2-201; EN 61810-1; EN 61373; UL 508
--------------------------	--

Elementary relay

WAGO elementary relay	857-155
-----------------------	---------

Commercial data

Product Group	6 (Interface Electronics)
Packaging type	BOX
Country of origin	DE
GTIN	4045454482459
Customs Tariff No.	85364900990

Approvals / Certificates

Ex-Approvals

Logo	Approval	Additional Approval Text	Certificate name
	UL UL International Germany GmbH (HAZARDOUS LOCATIONS)	ANSI/ISA 12.12.01	E198726 Sec.4

UL-Approvals

Logo	Approval	Additional Approval Text	Certificate name
	UL UL International Netherlands B.V. (ORDINARY LOCATIONS)	UL 508	E175199 Sec.4

Subject to changes. Please also observe the further product documentation!

WAGO Kontakttechnik GmbH & Co. KG
Hansastr. 27
32423 Minden
Phone: +49571 887-0 | Fax: +49571 887-169
Email: info.de@wago.com | Web: www.wago.com

Do you have any questions about our products?
We are always happy to take your call at +49 (571) 887-44222.

This item has been discontinued and as of 08.07.2019, can no longer be delivered.



Data sheet | Item number: 857-306









www.wago.com/857-306



Counterpart

Compatible products

Marking accessories

	Item no.: 2009-110 Marking strips; on reel; not stretchable; plain; snap-on type; white	www.wago.com/2009-110
	Item no.: 2009-115 WMB-Inline; for Smart Printer; 1500 pieces on roll; stretchable 5 - 5.2 mm; plain; snap-on type; white	www.wago.com/2009-115
	Item no.: 2009-115/000-002 WMB-Inline; for Smart Printer; 1500 pieces on roll; stretchable 5 - 5.2 mm; plain; snap-on type; yellow	www.wago.com/2009-115/000-002
	Item no.: 2009-115/000-006 WMB-Inline; for Smart Printer; 1500 pieces on roll; stretchable 5 - 5.2 mm; plain; snap-on type; blue	www.wago.com/2009-115/000-006
	Item no.: 2009-115/000-007 WMB-Inline; for Smart Printer; 1500 pieces on roll; stretchable 5 - 5.2 mm; plain; snap-on type; gray	www.wago.com/2009-115/000-007
	Item no.: 2009-115/000-012 WMB-Inline; for Smart Printer; 1500 pieces on roll; stretchable 5 - 5.2 mm; plain; snap-on type; orange	www.wago.com/2009-115/000-012
	Item no.: 2009-115/000-017 WMB-Inline; for Smart Printer; 1500 pieces on roll; stretchable 5 - 5.2 mm; plain; snap-on type; light green	www.wago.com/2009-115/000-017
	Item no.: 2009-115/000-023 WMB-Inline; for Smart Printer; 1500 pieces on roll; stretchable 5 - 5.2 mm; plain; snap-on type; green	www.wago.com/2009-115/000-023
	Item no.: 2009-115/000-024 WMB-Inline; for Smart Printer; 1500 pieces on roll; stretchable 5 - 5.2 mm; plain; snap-on type; violet	www.wago.com/2009-115/000-024

Subject to changes. Please also observe the further product documentation!

WAGO Kontakttechnik GmbH & Co. KG
Hansastr. 27
32423 Minden
Phone: +49571 887-0 | Fax: +49571 887-169
Email: info.de@wago.com | Web: www.wago.com

Do you have any questions about our products?
We are always happy to take your call at +49 (571) 887-44222.

This item has been discontinued and as of 08.07.2019, can no longer be delivered.



Data sheet | Item number: 857-306

www.wago.com/857-306



Item no.: 209-128
Adaptor; gray

www.wago.com/209-128



Item no.: 209-183
Marker card; white

www.wago.com/209-183



Item no.: 210-110
Fiber-tip pen

www.wago.com/210-110



Item no.: 793-501
WMB marking card; as card; not stretchable; plain; snap-on type; white

www.wago.com/793-501



Item no.: 793-501/000-002
WMB marking card; as card; not stretchable; plain; snap-on type; yellow

www.wago.com/793-501/000-002



Item no.: 793-501/000-005
WMB marking card; as card; not stretchable; plain; snap-on type; red

www.wago.com/793-501/000-005



Item no.: 793-501/000-006
WMB marking card; as card; not stretchable; plain; snap-on type; blue

www.wago.com/793-501/000-006



Item no.: 793-501/000-007
WMB marking card; as card; not stretchable; plain; snap-on type; gray

www.wago.com/793-501/000-007



Item no.: 793-501/000-012
WMB marking card; as card; not stretchable; plain; snap-on type; orange

www.wago.com/793-501/000-012



Item no.: 793-501/000-017
WMB marking card; as card; not stretchable; plain; snap-on type; light green

www.wago.com/793-501/000-017



Item no.: 793-501/000-023
WMB marking card; as card; not stretchable; plain; snap-on type; green

www.wago.com/793-501/000-023



Item no.: 793-501/000-024
WMB marking card; as card; not stretchable; plain; snap-on type; violet

www.wago.com/793-501/000-024



Item no.: 793-502
WMB marking card; as card; MARKED; 1 ... 10 (10x); not stretchable; Horizontal marking; snap-on type; white

www.wago.com/793-502



Item no.: 793-502/000-002
WMB marking card; as card; MARKED; 1 ... 10 (10x); not stretchable; Horizontal marking; snap-on type; yellow

www.wago.com/793-502/000-002

Item no.: 793-502/000-005
WMB marking card; as card; MARKED; 1 ... 10 (10x); not stretchable; Horizontal marking; snap-on type;

Subject to changes. Please also observe the further product documentation!

WAGO Kontakttechnik GmbH & Co. KG
Hansastr. 27
32423 Minden
Phone: +49571 887-0 | Fax: +49571 887-169
Email: info.de@wago.com | Web: www.wago.com

Do you have any questions about our products?
We are always happy to take your call at +49 (571) 887-44222.

This item has been discontinued and as of 08.07.2019, can no longer be delivered.



Data sheet | Item number: 857-306

www.wago.com/857-306



red

www.wago.com/793-502/000-005



Item no.: 793-502/000-006

WMB marking card; as card; MARKED; 1 ... 10 (10x); not stretchable; Horizontal marking; snap-on type; blue

www.wago.com/793-502/000-006



Item no.: 793-502/000-007

WMB marking card; as card; MARKED; 1 ... 10 (10x); not stretchable; Horizontal marking; snap-on type; gray

www.wago.com/793-502/000-007



Item no.: 793-502/000-012

WMB marking card; as card; MARKED; 1 ... 10 (10x); not stretchable; Horizontal marking; snap-on type; orange

www.wago.com/793-502/000-012



Item no.: 793-502/000-017

WMB marking card; as card; MARKED; 1 ... 10 (10x); not stretchable; Horizontal marking; snap-on type; light green

www.wago.com/793-502/000-017



Item no.: 793-502/000-023

WMB marking card; as card; MARKED; 1 ... 10 (10x); not stretchable; Horizontal marking; snap-on type; green

www.wago.com/793-502/000-023



Item no.: 793-502/000-024

WMB marking card; as card; MARKED; 1 ... 10 (10x); not stretchable; Horizontal marking; snap-on type; violet

www.wago.com/793-502/000-024



Item no.: 793-503

WMB marking card; as card; MARKED; 11 ... 20 (10x); not stretchable; Horizontal marking; snap-on type; white

www.wago.com/793-503



Item no.: 793-503/000-002

WMB marking card; as card; MARKED; 11 ... 20 (10x); not stretchable; Horizontal marking; snap-on type; yellow

www.wago.com/793-503/000-002



Item no.: 793-503/000-005

WMB marking card; as card; MARKED; 11 ... 20 (10x); not stretchable; Horizontal marking; snap-on type; red

www.wago.com/793-503/000-005



Item no.: 793-503/000-006

WMB marking card; as card; MARKED; 11 ... 20 (10x); not stretchable; Horizontal marking; snap-on type; blue

www.wago.com/793-503/000-006



Item no.: 793-503/000-007

WMB marking card; as card; MARKED; 11 ... 20 (10x); not stretchable; Horizontal marking; snap-on type; gray

www.wago.com/793-503/000-007



Item no.: 793-503/000-012

WMB marking card; as card; MARKED; 11 ... 20 (10x); not stretchable; Horizontal marking; snap-on type; orange

www.wago.com/793-503/000-012

Item no.: 793-503/000-017

Subject to changes. Please also observe the further product documentation!

WAGO Kontakttechnik GmbH & Co. KG
Hansastr. 27
32423 Minden
Phone: +49571 887-0 | Fax: +49571 887-169
Email: info.de@wago.com | Web: www.wago.com

Do you have any questions about our products?
We are always happy to take your call at +49 (571) 887-44222.

This item has been discontinued and as of 08.07.2019, can no longer be delivered.



Data sheet | Item number: 857-306

www.wago.com/857-306



WMB marking card; as card; MARKED; 11 ... 20 (10x); not stretchable; Horizontal marking; snap-on type; light green

www.wago.com/793-503/000-017



Item no.: 793-503/000-023

WMB marking card; as card; MARKED; 11 ... 20 (10x); not stretchable; Horizontal marking; snap-on type; green

www.wago.com/793-503/000-023



Item no.: 793-503/000-024

WMB marking card; as card; MARKED; 11 ... 20 (10x); not stretchable; Horizontal marking; snap-on type; violet

www.wago.com/793-503/000-024



Item no.: 793-504

WMB marking card; as card; MARKED; 21 ... 30 (10x); not stretchable; Horizontal marking; snap-on type; white

www.wago.com/793-504



Item no.: 793-504/000-002

WMB marking card; as card; MARKED; 21 ... 30 (10x); not stretchable; Horizontal marking; snap-on type; yellow

www.wago.com/793-504/000-002



Item no.: 793-504/000-005

WMB marking card; as card; MARKED; 21 ... 30 (10x); not stretchable; Horizontal marking; snap-on type; red

www.wago.com/793-504/000-005



Item no.: 793-504/000-006

WMB marking card; as card; MARKED; 21 ... 30 (10x); not stretchable; Horizontal marking; snap-on type; blue

www.wago.com/793-504/000-006



Item no.: 793-504/000-012

WMB marking card; as card; MARKED; 21 ... 30 (10x); not stretchable; Horizontal marking; snap-on type; orange

www.wago.com/793-504/000-012



Item no.: 793-504/000-017

WMB marking card; as card; MARKED; 21 ... 30 (10x); not stretchable; Horizontal marking; snap-on type; light green

www.wago.com/793-504/000-017



Item no.: 793-504/000-023

WMB marking card; as card; MARKED; 21 ... 30 (10x); not stretchable; Horizontal marking; snap-on type; green

www.wago.com/793-504/000-023



Item no.: 793-505

WMB marking card; as card; MARKED; 31 ... 40 (10x); not stretchable; Horizontal marking; snap-on type; white

www.wago.com/793-505



Item no.: 793-505/000-005

WMB marking card; as card; MARKED; 31 ... 40 (10x); not stretchable; Horizontal marking; snap-on type; red

www.wago.com/793-505/000-005



Item no.: 793-505/000-006

WMB marking card; as card; MARKED; 31 ... 40 (10x); not stretchable; Horizontal marking; snap-on type; blue

www.wago.com/793-505/000-006

Item no.: 793-505/000-007

WMB marking card; as card; MARKED; 31 ... 40 (10x); not stretchable; Horizontal marking; snap-on type;

Subject to changes. Please also observe the further product documentation!

WAGO Kontakttechnik GmbH & Co. KG

Hansastr. 27

32423 Minden

Phone: +49571 887-0 | Fax: +49571 887-169

Email: info.de@wago.com | Web: www.wago.com

Do you have any questions about our products?

We are always happy to take your call at +49 (571) 887-44222.

This item has been discontinued and as of 08.07.2019, can no longer be delivered.



Data sheet | Item number: 857-306

www.wago.com/857-306



gray

www.wago.com/793-505/000-007



Item no.: 793-505/000-012

WMB marking card; as card; MARKED; 31 ... 40 (10x); not stretchable; Horizontal marking; snap-on type; orange

www.wago.com/793-505/000-012



Item no.: 793-506

WMB marking card; as card; MARKED; 41 ... 50 (10x); not stretchable; Horizontal marking; snap-on type; white

www.wago.com/793-506



Item no.: 793-506/000-005

WMB marking card; as card; MARKED; 41 ... 50 (10x); not stretchable; Horizontal marking; snap-on type; red

www.wago.com/793-506/000-005



Item no.: 793-506/000-006

WMB marking card; as card; MARKED; 41 ... 50 (10x); not stretchable; Horizontal marking; snap-on type; blue

www.wago.com/793-506/000-006



Item no.: 793-506/000-012

WMB marking card; as card; MARKED; 41 ... 50 (10x); not stretchable; Horizontal marking; snap-on type; orange

www.wago.com/793-506/000-012



Item no.: 793-506/000-017

WMB marking card; as card; MARKED; 41 ... 50 (10x); not stretchable; Horizontal marking; snap-on type; light green

www.wago.com/793-506/000-017



Item no.: 793-5501

WMB marking card; as card; for terminal block width 5 - 17.5 mm; stretchable 5 - 5.2 mm; plain; snap-on type; white

www.wago.com/793-5501



Item no.: 793-5501/000-002

WMB marking card; as card; for terminal block width 5 - 17.5 mm; stretchable 5 - 5.2 mm; plain; snap-on type; yellow

www.wago.com/793-5501/000-002



Item no.: 793-5501/000-005

WMB marking card; as card; for terminal block width 5 - 17.5 mm; stretchable 5 - 5.2 mm; plain; snap-on type; red

www.wago.com/793-5501/000-005



Item no.: 793-5501/000-006

WMB marking card; as card; for terminal block width 5 - 17.5 mm; stretchable 5 - 5.2 mm; plain; snap-on type; blue

www.wago.com/793-5501/000-006



Item no.: 793-5501/000-007

WMB marking card; as card; for terminal block width 5 - 17.5 mm; stretchable 5 - 5.2 mm; plain; snap-on type; gray

www.wago.com/793-5501/000-007



Item no.: 793-5501/000-012

WMB marking card; as card; for terminal block width 5 - 17.5 mm; stretchable 5 - 5.2 mm; plain; snap-on type; orange

www.wago.com/793-5501/000-012

Item no.: 793-5501/000-014

WMB marking card; as card; for terminal block width 5 - 17.5 mm; stretchable 5 - 5.2 mm; plain; snap-on

Subject to changes. Please also observe the further product documentation!

WAGO Kontakttechnik GmbH & Co. KG
Hansastr. 27
32423 Minden
Phone: +49571 887-0 | Fax: +49571 887-169
Email: info.de@wago.com | Web: www.wago.com

Do you have any questions about our products?
We are always happy to take your call at +49 (571) 887-44222.

This item has been discontinued and as of 08.07.2019, can no longer be delivered.



Data sheet | Item number: 857-306

www.wago.com/857-306



type; brown

www.wago.com/793-5501/000-014



Item no.: 793-5501/000-017

WMB marking card; as card; for terminal block width 5 - 17.5 mm; stretchable 5 - 5.2 mm; plain; snap-on type; green

www.wago.com/793-5501/000-017



Item no.: 793-5501/000-023

WMB marking card; as card; for terminal block width 5 - 17.5 mm; stretchable 5 - 5.2 mm; plain; snap-on type; light green

www.wago.com/793-5501/000-023



Item no.: 793-5501/000-024

WMB marking card; as card; for terminal block width 5 - 17.5 mm; stretchable 5 - 5.2 mm; plain; snap-on type; violet

www.wago.com/793-5501/000-024



Item no.: 793-566

WMB marking card; as card; MARKED; 1 ... 50 (2x); not stretchable; Horizontal marking; snap-on type; white

www.wago.com/793-566



Item no.: 793-566/000-002

WMB marking card; as card; MARKED; 1 ... 50 (2x); not stretchable; Horizontal marking; snap-on type; yellow

www.wago.com/793-566/000-002



Item no.: 793-566/000-005

WMB marking card; as card; MARKED; 1 ... 50 (2x); not stretchable; Horizontal marking; snap-on type; red

www.wago.com/793-566/000-005



Item no.: 793-566/000-006

WMB marking card; as card; MARKED; 1 ... 50 (2x); not stretchable; Horizontal marking; snap-on type; blue

www.wago.com/793-566/000-006



Item no.: 793-566/000-007

WMB marking card; as card; MARKED; 1 ... 50 (2x); not stretchable; Horizontal marking; snap-on type; gray

www.wago.com/793-566/000-007



Item no.: 793-566/000-012

WMB marking card; as card; MARKED; 1 ... 50 (2x); not stretchable; Horizontal marking; snap-on type; orange

www.wago.com/793-566/000-012



Item no.: 793-566/000-017

WMB marking card; as card; MARKED; 1 ... 50 (2x); not stretchable; Horizontal marking; snap-on type; light green

www.wago.com/793-566/000-017



Item no.: 793-566/000-023

WMB marking card; as card; MARKED; 1 ... 50 (2x); not stretchable; Horizontal marking; snap-on type; green

www.wago.com/793-566/000-023



Item no.: 793-566/000-024

WMB marking card; as card; MARKED; 1 ... 50 (2x); not stretchable; Horizontal marking; snap-on type; violet

www.wago.com/793-566/000-024

Jumper

Subject to changes. Please also observe the further product documentation!

WAGO Kontakttechnik GmbH & Co. KG

Hansastr. 27

32423 Minden

Phone: +49571 887-0 | Fax: +49571 887-169

Email: info.de@wago.com | Web: www.wago.com

Do you have any questions about our products?















We are always happy to take your call at +49 (571) 887-44222.

This item has been discontinued and as of 08.07.2019, can no longer be delivered.



Data sheet | Item number: 857-306

www.wago.com/857-306

	Item no.: 281-482 Comb-style jumper bar; insulated; 2-way; IN = IN terminal block; gray	www.wago.com/281-482
	Item no.: 859-402 Push-in type jumper bar; 2-way; Nominal current 18 A; insulated; light gray	www.wago.com/859-402
	Item no.: 859-402/000-005 Push-in type jumper bar; 2-way; Nominal current 18 A; insulated; red	www.wago.com/859-402/000-005
	Item no.: 859-402/000-006 Push-in type jumper bar; 2-way; Nominal current 18 A; insulated; blue	www.wago.com/859-402/000-006
	Item no.: 859-402/000-029 Push-in type jumper bar; 2-way; Nominal current 18 A; insulated; yellow	www.wago.com/859-402/000-029
	Item no.: 859-403 Push-in type jumper bar; 3-way; Nominal current 18 A; insulated; light gray	www.wago.com/859-403
	Item no.: 859-403/000-005 Push-in type jumper bar; 3-way; Nominal current 18 A; insulated; red	www.wago.com/859-403/000-005
	Item no.: 859-403/000-006 Push-in type jumper bar; 3-way; Nominal current 18 A; insulated; blue	www.wago.com/859-403/000-006
	Item no.: 859-403/000-029 Push-in type jumper bar; 3-way; Nominal current 18 A; insulated; yellow	www.wago.com/859-403/000-029
	Item no.: 859-404 Push-in type jumper bar; 4-way; Nominal current 18 A; insulated; light gray	www.wago.com/859-404
	Item no.: 859-404/000-005 Push-in type jumper bar; 4-way; Nominal current 18 A; insulated; red	www.wago.com/859-404/000-005
	Item no.: 859-404/000-006 Push-in type jumper bar; 4-way; Nominal current 18 A; insulated; blue	www.wago.com/859-404/000-006
	Item no.: 859-404/000-029 Push-in type jumper bar; 4-way; Nominal current 18 A; insulated; yellow	www.wago.com/859-404/000-029
	Item no.: 859-405 Push-in type jumper bar; 5-way; Nominal current 18 A; insulated; light gray	www.wago.com/859-405
	Item no.: 859-405/000-005 Push-in type jumper bar; 5-way; Nominal current 18 A; insulated; red	www.wago.com/859-405/000-005

Subject to changes. Please also observe the further product documentation!

WAGO Kontakttechnik GmbH & Co. KG
Hansastr. 27
32423 Minden
Phone: +49571 887-0 | Fax: +49571 887-169
Email: info.de@wago.com | Web: www.wago.com















Do you have any questions about our products?
We are always happy to take your call at +49 (571) 887-44222.

This item has been discontinued and as of 08.07.2019, can no longer be delivered.



Data sheet | Item number: 857-306

www.wago.com/857-306

	Item no.: 859-405/000-006 Push-in type jumper bar; 5-way; Nominal current 18 A; insulated; blue	www.wago.com/859-405/000-006
	Item no.: 859-405/000-029 Push-in type jumper bar; 5-way; Nominal current 18 A; insulated; yellow	www.wago.com/859-405/000-029
	Item no.: 859-406 Push-in type jumper bar; 6-way; Nominal current 18 A; insulated; light gray	www.wago.com/859-406
	Item no.: 859-406/000-005 Push-in type jumper bar; 6-way; Nominal current 18 A; insulated; red	www.wago.com/859-406/000-005
	Item no.: 859-406/000-006 Push-in type jumper bar; 6-way; Nominal current 18 A; insulated; blue	www.wago.com/859-406/000-006
	Item no.: 859-406/000-029 Push-in type jumper bar; 6-way; Nominal current 18 A; insulated; yellow	www.wago.com/859-406/000-029
	Item no.: 859-407 Push-in type jumper bar; 7-way; Nominal current 18 A; insulated; light gray	www.wago.com/859-407
	Item no.: 859-407/000-005 Push-in type jumper bar; 7-way; Nominal current 18 A; insulated; red	www.wago.com/859-407/000-005
	Item no.: 859-407/000-006 Push-in type jumper bar; 7-way; Nominal current 18 A; insulated; blue	www.wago.com/859-407/000-006
	Item no.: 859-407/000-029 Push-in type jumper bar; 7-way; Nominal current 18 A; insulated; yellow	www.wago.com/859-407/000-029
	Item no.: 859-408 Push-in type jumper bar; 8-way; Nominal current 18 A; insulated; light gray	www.wago.com/859-408
	Item no.: 859-408/000-005 Push-in type jumper bar; 8-way; Nominal current 18 A; insulated; red	www.wago.com/859-408/000-005
	Item no.: 859-408/000-006 Push-in type jumper bar; 8-way; Nominal current 18 A; insulated; blue	www.wago.com/859-408/000-006
	Item no.: 859-408/000-029 Push-in type jumper bar; 8-way; Nominal current 18 A; insulated; yellow	www.wago.com/859-408/000-029

Subject to changes. Please also observe the further product documentation!

WAGO Kontakttechnik GmbH & Co. KG
Hansastr. 27
32423 Minden
Phone: +49571 887-0 | Fax: +49571 887-169
Email: info.de@wago.com | Web: www.wago.com















Do you have any questions about our products?
We are always happy to take your call at +49 (571) 887-44222.

This item has been discontinued and as of 08.07.2019, can no longer be delivered.



Data sheet | Item number: 857-306

www.wago.com/857-306

	Item no.: 859-409 Push-in type jumper bar; 9-way; Nominal current 18 A; insulated; light gray	www.wago.com/859-409
	Item no.: 859-409/000-005 Push-in type jumper bar; 9-way; Nominal current 18 A; insulated; red	www.wago.com/859-409/000-005
	Item no.: 859-409/000-006 Push-in type jumper bar; 9-way; Nominal current 18 A; insulated; blue	www.wago.com/859-409/000-006
	Item no.: 859-409/000-029 Push-in type jumper bar; 9-way; Nominal current 18 A; insulated; yellow	www.wago.com/859-409/000-029
	Item no.: 859-410 Push-in type jumper bar; 10-way; Nominal current 18 A; insulated; light gray	www.wago.com/859-410
	Item no.: 859-410/000-005 Push-in type jumper bar; 10-way; Nominal current 18 A; insulated; red	www.wago.com/859-410/000-005
	Item no.: 859-410/000-006 Push-in type jumper bar; 10-way; Nominal current 18 A; insulated; blue	www.wago.com/859-410/000-006
	Item no.: 859-410/000-029 Push-in type jumper bar; 10-way; Nominal current 18 A; insulated; yellow	www.wago.com/859-410/000-029
tools		
	Item no.: 210-720 Operating tool; Blade: 3.5 x 0.5 mm; with a partially insulated shaft	www.wago.com/210-720
General accessories		
	Item no.: 209-184 Protection cover; transparent	www.wago.com/209-184
	Item no.: 249-105 Group marker carrier; gray	www.wago.com/249-105
	Item no.: 857-155 Basic relay; Nominal input voltage: 60 VDC; 1 changeover contact; Limiting continuous current: 6 A; Module width: 5 mm; Module height: 15 mm	www.wago.com/857-155
ferrule		
	Item no.: 216-241 Ferrule; Sleeve for 0.5 mm ² / 20 AWG; insulated; electro-tin plated; electrolytic copper; gastight crimped; acc. to DIN 46228, Part 4/09.90; white	www.wago.com/216-241
	Item no.: 216-242 Ferrule; Sleeve for 0.75 mm ² / 18 AWG; insulated; electro-tin plated; electrolytic copper; gastight crimped; acc. to DIN 46228, Part 4/09.90; gray	www.wago.com/216-242
	Item no.: 216-243	

Subject to changes. Please also observe the further product documentation!

WAGO Kontakttechnik GmbH & Co. KG
Hansastr. 27
32423 Minden
Phone: +49571 887-0 | Fax: +49571 887-169
Email: info.de@wago.com | Web: www.wago.com

Do you have any questions about our products?
We are always happy to take your call at +49 (571) 887-44222.

This item has been discontinued and as of 08.07.2019, can no longer be delivered.



Data sheet | Item number: 857-306

www.wago.com/857-306



Ferrule; Sleeve for 1 mm² / AWG 18; insulated; electro-tin plated; electrolytic copper; gastight crimped; acc. to DIN 46228, Part 4/09.90; red www.wago.com/216-243



Item no.: 216-244

Ferrule; Sleeve for 1.5 mm² / AWG 16; insulated; electro-tin plated; electrolytic copper; gastight crimped; acc. to DIN 46228, Part 4/09.90; black www.wago.com/216-244

Downloads

Documentation

Instruction Leaflet

Relaisbaustein mit steckbarem Kleinschaltrelais 1 Wechsler (1u) Eingangsnennspannung DC 60 V	pdf 2.4 MB	Download
---	---------------	----------

Additional Information

Disposal; Electrical and electronic equipment, Packaging	V 1.0.0	pdf 265.8 kB	Download
Step Datei Serie 857-03xx	1.0 Jun 20, 2011	ifc 299.3 kB	Download

CAD/CAE-Data

CAD data

2D/3D Models 857-306	URL	Download
----------------------	-----	----------

CAE data

EPLAN Data Portal 857-306	URL	Download
WSCAD Universe 857-306	URL	Download

Installation Notes

Subject to changes. Please also observe the further product documentation!

WAGO Kontakttechnik GmbH & Co. KG
Hansastr. 27
32423 Minden
Phone: +49571 887-0 | Fax: +49571 887-169
Email: info.de@wago.com | Web: www.wago.com

Do you have any questions about our products?
We are always happy to take your call at +49 (571) 887-44222.