

**Data sheet | Item number: 857-358**

Relay module; Nominal input voltage: 230 V AC/DC; 1 changeover contact;  
Limiting continuous current: 6 A; Yellow status indicator; Module width: 6  
mm; 2,50 mm<sup>2</sup>; gray

[www.wago.com/857-358](http://www.wago.com/857-358)

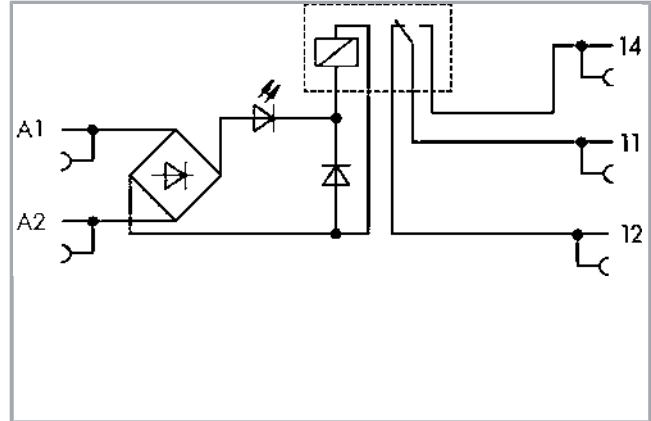

RoHS  Compliant

[BOMcheck.net](https://www.bomcheck.net)

Color: ■

Subject to changes. Please also observe the further product documentation!

WAGO Kontakttechnik GmbH & Co. KG  
Hansastr. 27  
32423 Minden  
Phone: +49571 887-0 | Fax: +49571 887-169  
Email: [info.de@wago.com](mailto:info.de@wago.com) | Web: [www.wago.com](http://www.wago.com)

Do you have any questions about our products?  
We are always happy to take your call at +49 (571) 887-44222.

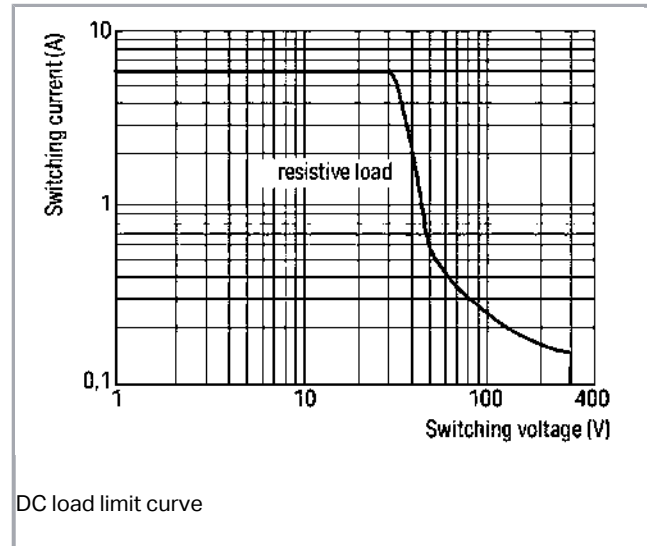
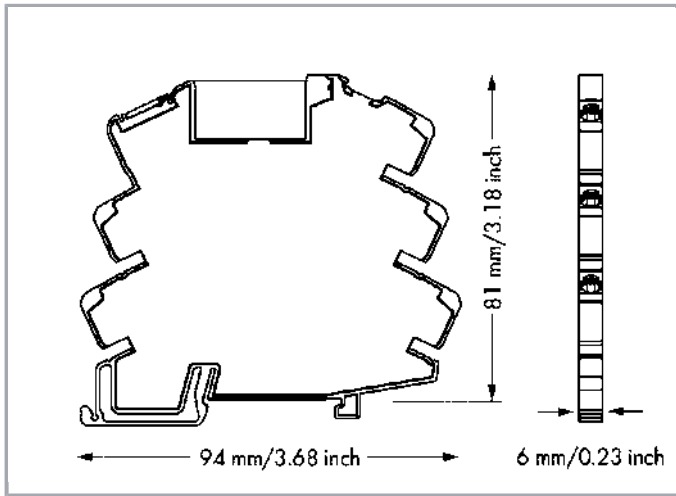

## Item description

### Note:

Inductive loads have to be attenuated by an appropriate protective circuit in order to protect relay coils and contacts.

## Data

### Technical Data

### Control circuit

Nominal input voltage $U_N$	AC/DC 230 V
Input voltage range	-20 ... +10 %
Nominal input current at $U_N$	3.5 mA

### Load circuit:

Number of changeover/switchover contacts	1
Contact material (relay)	AgSnO <sub>2</sub>
Limiting continuous current	6 A
Max. make current (resistive)	(AC) 20 A / 0.02 s
Max. switching voltage	AC 250 V
Max. switching power (resistive)	AC 1500 VA; DC see load limit curve
Switching capacity	AC-15: 3 A / AC 250 V; DC-13: 2 A / DC 24 V

Subject to changes. Please also observe the further product documentation!



Recommended minimum load	10 V / 10 mA; 24 V / 1 mA
Pull-in time (typ.)	15 ms
Drop-out time (typ.)	25 ms
Bounce time (typ.)	3.5 ms
Electrical life (N.O.; resistive load; 23 °C)	50 x 10 <sup>3</sup> switching operations
Mechanical life	5 x 10 <sup>6</sup> switching operations
Max. switching load with load/without load	6 min <sup>-1</sup> / 180 min <sup>-1</sup>

## Signaling

Status indication	LED yellow
-------------------	------------

## Safety and protection:

Rated voltage	250 V
Rated impulse voltage	4 kV
Pollution degree	2
Dielectric strength, control/load circuit (AC, 1 min)	4 kVrms
Dielectric strength open contact (AC, 1 min)	1 kVrms
Protection class	IP20

## Connection data

Connection technology	Push-in CAGE CLAMP®
Solid conductor	0.34 ... 2.5 mm <sup>2</sup> / 22 ... 14 AWG
Fine-stranded conductor	0.34 ... 2.5 mm <sup>2</sup> / 22 ... 14 AWG
Strip length	9 ... 10 mm / 0.35 ... 0.39 inch

## Geometrical Data

Width	6 mm / 0.236 inch
Height from upper-edge of DIN-35 rail	81 mm / 3.189 inch
Depth	94 mm / 3.701 inch

## Mechanical data

Type of mounting	DIN-35 rail
------------------	-------------

## Material Data

Color	gray
-------	------

Subject to changes. Please also observe the further product documentation!

Fire load	0.651 MJ
Weight	32 g

### Environmental Requirements

Surrounding air (operating) temperature at $U_N$	-40 ... 60 °C
Surrounding air (storage) temperature	-40 ... 70 °C
Processing temperature	-25 ... +50 °C

### Standards and specifications

Standards/specifications	EN 61010-2-201; EN 61810-1; EN 61373; UL 508; GL; ATEX; IEC Ex
--------------------------	--

### Elementary relay



WAGO elementary relay	857-155
-----------------------	---------

### Commercial data

Product Group	6 (Interface Electronics)
Packaging type	BOX
Country of origin	CN
GTIN	4045454471576
Customs Tariff No.	85364900990

### Approvals / Certificates

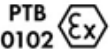
#### Ex-Approvals





Logo	Approval	Additional Approval Text	Certificate name
	ATEX DEKRA EXAM GmbH	EN 60079-0	BVS_14_ATEX_E_091_X
	IECEX DEKRA EXAM GmbH	IEC 60079-0	IECEX_BVS_14.0079_X
	UL UL International Germany GmbH (HAZARDOUS LOCATIONS)	ANSI/ISA 12.12.01	E198726 Sec.4

#### Ship Approvals

Subject to changes. Please also observe the further product documentation!

WAGO Kontakttechnik GmbH & Co. KG  
 Hansastr. 27  
 32423 Minden  
 Phone: +49571 887-0 | Fax: +49571 887-169  
 Email: [info.de@wago.com](mailto:info.de@wago.com) | Web: [www.wago.com](http://www.wago.com)

Do you have any questions about our products?  
 We are always happy to take your call at +49 (571) 887-44222.

Logo	Approval	Additional Approval Text	Certificate name
	<b>BV</b> Bureau Veritas S.A.	-	40179_A0
	<b>DNV GL</b> Det Norske Veritas, Germanischer Lloyd	-	TAA00001D1
	<b>NK</b> Nippon Kaiji Kyokai	-	TA17255M
	<b>PRS</b> Polski Rejestr Statków	-	TE/2186 /880590/18



#### UL-Approvals

Logo	Approval	Additional Approval Text	Certificate name
	<b>UL</b> UL International Netherlands B.V. (ORDINARY LOCATIONS)	UL 508	E175199 Sec.4















#### Counterpart

#### Compatible products













#### Marking accessories

	<b>Item no.: 2009-110</b> Marking strips; on reel; not stretchable; plain; snap-on type; white	<a href="http://www.wago.com/2009-110">www.wago.com/2009-110</a>
	<b>Item no.: 2009-115</b> WMB-Inline; for Smart Printer; 1500 pieces on roll; stretchable 5 - 5.2 mm; plain; snap-on type; white	<a href="http://www.wago.com/2009-115">www.wago.com/2009-115</a>

Subject to changes. Please also observe the further product documentation!

	<b>Item no.: 2009-115/000-002</b> WMB-Inline; for Smart Printer; 1500 pieces on roll; stretchable 5 - 5.2 mm; plain; snap-on type; yellow	<a href="http://www.wago.com/2009-115/000-002">www.wago.com/2009-115/000-002</a>
	<b>Item no.: 2009-115/000-006</b> WMB-Inline; for Smart Printer; 1500 pieces on roll; stretchable 5 - 5.2 mm; plain; snap-on type; blue	<a href="http://www.wago.com/2009-115/000-006">www.wago.com/2009-115/000-006</a>
	<b>Item no.: 2009-115/000-007</b> WMB-Inline; for Smart Printer; 1500 pieces on roll; stretchable 5 - 5.2 mm; plain; snap-on type; gray	<a href="http://www.wago.com/2009-115/000-007">www.wago.com/2009-115/000-007</a>
	<b>Item no.: 2009-115/000-012</b> WMB-Inline; for Smart Printer; 1500 pieces on roll; stretchable 5 - 5.2 mm; plain; snap-on type; orange	<a href="http://www.wago.com/2009-115/000-012">www.wago.com/2009-115/000-012</a>
	<b>Item no.: 2009-115/000-017</b> WMB-Inline; for Smart Printer; 1500 pieces on roll; stretchable 5 - 5.2 mm; plain; snap-on type; light green	<a href="http://www.wago.com/2009-115/000-017">www.wago.com/2009-115/000-017</a>
	<b>Item no.: 2009-115/000-023</b> WMB-Inline; for Smart Printer; 1500 pieces on roll; stretchable 5 - 5.2 mm; plain; snap-on type; green	<a href="http://www.wago.com/2009-115/000-023">www.wago.com/2009-115/000-023</a>
	<b>Item no.: 2009-115/000-024</b> WMB-Inline; for Smart Printer; 1500 pieces on roll; stretchable 5 - 5.2 mm; plain; snap-on type; violet	<a href="http://www.wago.com/2009-115/000-024">www.wago.com/2009-115/000-024</a>
	<b>Item no.: 209-128</b> Adaptor; gray	<a href="http://www.wago.com/209-128">www.wago.com/209-128</a>
	<b>Item no.: 209-183</b> Marker card; white	<a href="http://www.wago.com/209-183">www.wago.com/209-183</a>
	<b>Item no.: 210-110</b> Fiber-tip pen	<a href="http://www.wago.com/210-110">www.wago.com/210-110</a>
	<b>Item no.: 249-105</b> Group marker carrier; gray	<a href="http://www.wago.com/249-105">www.wago.com/249-105</a>
	<b>Item no.: 793-501</b> WMB marking card; as card; not stretchable; plain; snap-on type; white	<a href="http://www.wago.com/793-501">www.wago.com/793-501</a>
	<b>Item no.: 793-501/000-002</b> WMB marking card; as card; not stretchable; plain; snap-on type; yellow	<a href="http://www.wago.com/793-501/000-002">www.wago.com/793-501/000-002</a>
	<b>Item no.: 793-501/000-005</b> WMB marking card; as card; not stretchable; plain; snap-on type; red	<a href="http://www.wago.com/793-501/000-005">www.wago.com/793-501/000-005</a>
	<b>Item no.: 793-501/000-006</b> WMB marking card; as card; not stretchable; plain; snap-on type; blue	<a href="http://www.wago.com/793-501/000-006">www.wago.com/793-501/000-006</a>

Subject to changes. Please also observe the further product documentation!

	<b>Item no.: 793-501/000-007</b> WMB marking card; as card; not stretchable; plain; snap-on type; gray	<a href="http://www.wago.com/793-501/000-007">www.wago.com/793-501/000-007</a>
	<b>Item no.: 793-501/000-012</b> WMB marking card; as card; not stretchable; plain; snap-on type; orange	<a href="http://www.wago.com/793-501/000-012">www.wago.com/793-501/000-012</a>
	<b>Item no.: 793-501/000-017</b> WMB marking card; as card; not stretchable; plain; snap-on type; light green	<a href="http://www.wago.com/793-501/000-017">www.wago.com/793-501/000-017</a>
	<b>Item no.: 793-501/000-023</b> WMB marking card; as card; not stretchable; plain; snap-on type; green	<a href="http://www.wago.com/793-501/000-023">www.wago.com/793-501/000-023</a>
	<b>Item no.: 793-501/000-024</b> WMB marking card; as card; not stretchable; plain; snap-on type; violet	<a href="http://www.wago.com/793-501/000-024">www.wago.com/793-501/000-024</a>
	<b>Item no.: 793-502</b> WMB marking card; as card; MARKED; 1 ... 10 (10x); not stretchable; Horizontal marking; snap-on type; white	<a href="http://www.wago.com/793-502">www.wago.com/793-502</a>
	<b>Item no.: 793-502/000-002</b> WMB marking card; as card; MARKED; 1 ... 10 (10x); not stretchable; Horizontal marking; snap-on type; yellow	<a href="http://www.wago.com/793-502/000-002">www.wago.com/793-502/000-002</a>
	<b>Item no.: 793-502/000-005</b> WMB marking card; as card; MARKED; 1 ... 10 (10x); not stretchable; Horizontal marking; snap-on type; red	<a href="http://www.wago.com/793-502/000-005">www.wago.com/793-502/000-005</a>
	<b>Item no.: 793-502/000-006</b> WMB marking card; as card; MARKED; 1 ... 10 (10x); not stretchable; Horizontal marking; snap-on type; blue	<a href="http://www.wago.com/793-502/000-006">www.wago.com/793-502/000-006</a>
	<b>Item no.: 793-502/000-007</b> WMB marking card; as card; MARKED; 1 ... 10 (10x); not stretchable; Horizontal marking; snap-on type; gray	<a href="http://www.wago.com/793-502/000-007">www.wago.com/793-502/000-007</a>
	<b>Item no.: 793-502/000-012</b> WMB marking card; as card; MARKED; 1 ... 10 (10x); not stretchable; Horizontal marking; snap-on type; orange	<a href="http://www.wago.com/793-502/000-012">www.wago.com/793-502/000-012</a>
	<b>Item no.: 793-502/000-017</b> WMB marking card; as card; MARKED; 1 ... 10 (10x); not stretchable; Horizontal marking; snap-on type; light green	<a href="http://www.wago.com/793-502/000-017">www.wago.com/793-502/000-017</a>
	<b>Item no.: 793-502/000-023</b> WMB marking card; as card; MARKED; 1 ... 10 (10x); not stretchable; Horizontal marking; snap-on type; green	<a href="http://www.wago.com/793-502/000-023">www.wago.com/793-502/000-023</a>
	<b>Item no.: 793-502/000-024</b>	

Subject to changes. Please also observe the further product documentation!



WMB marking card; as card; MARKED; 1 ... 10 (10x); not stretchable; Horizontal marking; snap-on type; [www.wago.com/793-502/000-024](http://www.wago.com/793-502/000-024)  
violet

**Item no.: 793-503**



WMB marking card; as card; MARKED; 11 ... 20 (10x); not stretchable; Horizontal marking; snap-on type; [www.wago.com/793-503](http://www.wago.com/793-503)  
white



**Item no.: 793-503/000-002**

WMB marking card; as card; MARKED; 11 ... 20 (10x); not stretchable; Horizontal marking; snap-on type; [www.wago.com/793-503/000-002](http://www.wago.com/793-503/000-002)  
yellow



**Item no.: 793-503/000-005**

WMB marking card; as card; MARKED; 11 ... 20 (10x); not stretchable; Horizontal marking; snap-on type; [www.wago.com/793-503/000-005](http://www.wago.com/793-503/000-005)  
red



**Item no.: 793-503/000-006**

WMB marking card; as card; MARKED; 11 ... 20 (10x); not stretchable; Horizontal marking; snap-on type; [www.wago.com/793-503/000-006](http://www.wago.com/793-503/000-006)  
blue



**Item no.: 793-503/000-007**

WMB marking card; as card; MARKED; 11 ... 20 (10x); not stretchable; Horizontal marking; snap-on type; [www.wago.com/793-503/000-007](http://www.wago.com/793-503/000-007)  
gray



**Item no.: 793-503/000-012**

WMB marking card; as card; MARKED; 11 ... 20 (10x); not stretchable; Horizontal marking; snap-on type; [www.wago.com/793-503/000-012](http://www.wago.com/793-503/000-012)  
orange



**Item no.: 793-503/000-017**

WMB marking card; as card; MARKED; 11 ... 20 (10x); not stretchable; Horizontal marking; snap-on type; [www.wago.com/793-503/000-017](http://www.wago.com/793-503/000-017)  
light green



**Item no.: 793-503/000-023**

WMB marking card; as card; MARKED; 11 ... 20 (10x); not stretchable; Horizontal marking; snap-on type; [www.wago.com/793-503/000-023](http://www.wago.com/793-503/000-023)  
green



**Item no.: 793-503/000-024**

WMB marking card; as card; MARKED; 11 ... 20 (10x); not stretchable; Horizontal marking; snap-on type; [www.wago.com/793-503/000-024](http://www.wago.com/793-503/000-024)  
violet



**Item no.: 793-504**

WMB marking card; as card; MARKED; 21 ... 30 (10x); not stretchable; Horizontal marking; snap-on type; [www.wago.com/793-504](http://www.wago.com/793-504)  
white



**Item no.: 793-504/000-002**

WMB marking card; as card; MARKED; 21 ... 30 (10x); not stretchable; Horizontal marking; snap-on type; [www.wago.com/793-504/000-002](http://www.wago.com/793-504/000-002)  
yellow



**Item no.: 793-504/000-005**

WMB marking card; as card; MARKED; 21 ... 30 (10x); not stretchable; Horizontal marking; snap-on type; [www.wago.com/793-504/000-005](http://www.wago.com/793-504/000-005)  
red















**Item no.: 793-504/000-006**

WMB marking card; as card; MARKED; 21 ... 30 (10x); not stretchable; Horizontal marking; snap-on type; [www.wago.com/793-504/000-006](http://www.wago.com/793-504/000-006)  
blue

Subject to changes. Please also observe the further product documentation!



	<b>Item no.: 793-504/000-012</b> WMB marking card; as card; MARKED; 21 ... 30 (10x); not stretchable; Horizontal marking; snap-on type; orange	<a href="http://www.wago.com/793-504/000-012">www.wago.com/793-504/000-012</a>
	<b>Item no.: 793-504/000-017</b> WMB marking card; as card; MARKED; 21 ... 30 (10x); not stretchable; Horizontal marking; snap-on type; light green	<a href="http://www.wago.com/793-504/000-017">www.wago.com/793-504/000-017</a>
	<b>Item no.: 793-504/000-023</b> WMB marking card; as card; MARKED; 21 ... 30 (10x); not stretchable; Horizontal marking; snap-on type; green	<a href="http://www.wago.com/793-504/000-023">www.wago.com/793-504/000-023</a>
	<b>Item no.: 793-505</b> WMB marking card; as card; MARKED; 31 ... 40 (10x); not stretchable; Horizontal marking; snap-on type; white	<a href="http://www.wago.com/793-505">www.wago.com/793-505</a>
	<b>Item no.: 793-505/000-005</b> WMB marking card; as card; MARKED; 31 ... 40 (10x); not stretchable; Horizontal marking; snap-on type; red	<a href="http://www.wago.com/793-505/000-005">www.wago.com/793-505/000-005</a>
	<b>Item no.: 793-505/000-006</b> WMB marking card; as card; MARKED; 31 ... 40 (10x); not stretchable; Horizontal marking; snap-on type; blue	<a href="http://www.wago.com/793-505/000-006">www.wago.com/793-505/000-006</a>
	<b>Item no.: 793-505/000-007</b> WMB marking card; as card; MARKED; 31 ... 40 (10x); not stretchable; Horizontal marking; snap-on type; gray	<a href="http://www.wago.com/793-505/000-007">www.wago.com/793-505/000-007</a>
	<b>Item no.: 793-505/000-012</b> WMB marking card; as card; MARKED; 31 ... 40 (10x); not stretchable; Horizontal marking; snap-on type; orange	<a href="http://www.wago.com/793-505/000-012">www.wago.com/793-505/000-012</a>
	<b>Item no.: 793-506</b> WMB marking card; as card; MARKED; 41 ... 50 (10x); not stretchable; Horizontal marking; snap-on type; white	<a href="http://www.wago.com/793-506">www.wago.com/793-506</a>
	<b>Item no.: 793-506/000-005</b> WMB marking card; as card; MARKED; 41 ... 50 (10x); not stretchable; Horizontal marking; snap-on type; red	<a href="http://www.wago.com/793-506/000-005">www.wago.com/793-506/000-005</a>
	<b>Item no.: 793-506/000-006</b> WMB marking card; as card; MARKED; 41 ... 50 (10x); not stretchable; Horizontal marking; snap-on type; blue	<a href="http://www.wago.com/793-506/000-006">www.wago.com/793-506/000-006</a>
	<b>Item no.: 793-506/000-012</b> WMB marking card; as card; MARKED; 41 ... 50 (10x); not stretchable; Horizontal marking; snap-on type; orange	<a href="http://www.wago.com/793-506/000-012">www.wago.com/793-506/000-012</a>
	<b>Item no.: 793-506/000-017</b> WMB marking card; as card; MARKED; 41 ... 50 (10x); not stretchable; Horizontal marking; snap-on type; light green	<a href="http://www.wago.com/793-506/000-017">www.wago.com/793-506/000-017</a>
	<b>Item no.: 793-5501</b> WMB marking card; as card; for terminal block width 5 - 17.5 mm; stretchable 5 - 5.2 mm; plain; snap-on	<a href="http://www.wago.com/793-5501">www.wago.com/793-5501</a>

Subject to changes. Please also observe the further product documentation!



type; white

**Item no.: 793-5501/000-002**

WMB marking card; as card; for terminal block width 5 - 17.5 mm; stretchable 5 - 5.2 mm; plain; snap-on type; yellow

[www.wago.com/793-5501/000-002](http://www.wago.com/793-5501/000-002)**Item no.: 793-5501/000-005**

WMB marking card; as card; for terminal block width 5 - 17.5 mm; stretchable 5 - 5.2 mm; plain; snap-on type; red

[www.wago.com/793-5501/000-005](http://www.wago.com/793-5501/000-005)**Item no.: 793-5501/000-006**

WMB marking card; as card; for terminal block width 5 - 17.5 mm; stretchable 5 - 5.2 mm; plain; snap-on type; blue

[www.wago.com/793-5501/000-006](http://www.wago.com/793-5501/000-006)**Item no.: 793-5501/000-007**

WMB marking card; as card; for terminal block width 5 - 17.5 mm; stretchable 5 - 5.2 mm; plain; snap-on type; gray

[www.wago.com/793-5501/000-007](http://www.wago.com/793-5501/000-007)**Item no.: 793-5501/000-012**

WMB marking card; as card; for terminal block width 5 - 17.5 mm; stretchable 5 - 5.2 mm; plain; snap-on type; orange

[www.wago.com/793-5501/000-012](http://www.wago.com/793-5501/000-012)**Item no.: 793-5501/000-014**

WMB marking card; as card; for terminal block width 5 - 17.5 mm; stretchable 5 - 5.2 mm; plain; snap-on type; brown

[www.wago.com/793-5501/000-014](http://www.wago.com/793-5501/000-014)**Item no.: 793-5501/000-017**

WMB marking card; as card; for terminal block width 5 - 17.5 mm; stretchable 5 - 5.2 mm; plain; snap-on type; green

[www.wago.com/793-5501/000-017](http://www.wago.com/793-5501/000-017)**Item no.: 793-5501/000-023**

WMB marking card; as card; for terminal block width 5 - 17.5 mm; stretchable 5 - 5.2 mm; plain; snap-on type; light green

[www.wago.com/793-5501/000-023](http://www.wago.com/793-5501/000-023)**Item no.: 793-5501/000-024**

WMB marking card; as card; for terminal block width 5 - 17.5 mm; stretchable 5 - 5.2 mm; plain; snap-on type; violet

[www.wago.com/793-5501/000-024](http://www.wago.com/793-5501/000-024)**Item no.: 793-566**

WMB marking card; as card; MARKED; 1 ... 50 (2x); not stretchable; Horizontal marking; snap-on type; white

[www.wago.com/793-566](http://www.wago.com/793-566)**Item no.: 793-566/000-002**

WMB marking card; as card; MARKED; 1 ... 50 (2x); not stretchable; Horizontal marking; snap-on type; yellow

[www.wago.com/793-566/000-002](http://www.wago.com/793-566/000-002)**Item no.: 793-566/000-005**

WMB marking card; as card; MARKED; 1 ... 50 (2x); not stretchable; Horizontal marking; snap-on type; red

[www.wago.com/793-566/000-005](http://www.wago.com/793-566/000-005)**Item no.: 793-566/000-006**

WMB marking card; as card; MARKED; 1 ... 50 (2x); not stretchable; Horizontal marking; snap-on type; blue

[www.wago.com/793-566/000-006](http://www.wago.com/793-566/000-006)

Subject to changes. Please also observe the further product documentation!

WAGO Kontakttechnik GmbH &amp; Co. KG

Hansastr. 27















32423 Minden

Phone: +49571 887-0 | Fax: +49571 887-169















Email: [info.de@wago.com](mailto:info.de@wago.com) | Web: [www.wago.com](http://www.wago.com)

Do you have any questions about our products?















We are always happy to take your call at +49 (571) 887-44222.

	<b>Item no.: 793-566/000-007</b> WMB marking card; as card; MARKED; 1 ... 50 (2x); not stretchable; Horizontal marking; snap-on type; gray	<a href="http://www.wago.com/793-566/000-007">www.wago.com/793-566/000-007</a>
	<b>Item no.: 793-566/000-012</b> WMB marking card; as card; MARKED; 1 ... 50 (2x); not stretchable; Horizontal marking; snap-on type; orange	<a href="http://www.wago.com/793-566/000-012">www.wago.com/793-566/000-012</a>
	<b>Item no.: 793-566/000-017</b> WMB marking card; as card; MARKED; 1 ... 50 (2x); not stretchable; Horizontal marking; snap-on type; light green	<a href="http://www.wago.com/793-566/000-017">www.wago.com/793-566/000-017</a>
	<b>Item no.: 793-566/000-023</b> WMB marking card; as card; MARKED; 1 ... 50 (2x); not stretchable; Horizontal marking; snap-on type; green	<a href="http://www.wago.com/793-566/000-023">www.wago.com/793-566/000-023</a>
	<b>Item no.: 793-566/000-024</b> WMB marking card; as card; MARKED; 1 ... 50 (2x); not stretchable; Horizontal marking; snap-on type; violet	<a href="http://www.wago.com/793-566/000-024">www.wago.com/793-566/000-024</a>
<b>ferrule</b>		
	<b>Item no.: 216-241</b> Ferrule; Sleeve for 0.5 mm <sup>2</sup> / 20 AWG; insulated; electro-tin plated; electrolytic copper; gastight crimped; acc. to DIN 46228, Part 4/09.90; white	<a href="http://www.wago.com/216-241">www.wago.com/216-241</a>
	<b>Item no.: 216-242</b> Ferrule; Sleeve for 0.75 mm <sup>2</sup> / 18 AWG; insulated; electro-tin plated; electrolytic copper; gastight crimped; acc. to DIN 46228, Part 4/09.90; gray	<a href="http://www.wago.com/216-242">www.wago.com/216-242</a>
	<b>Item no.: 216-243</b> Ferrule; Sleeve for 1 mm <sup>2</sup> / AWG 18; insulated; electro-tin plated; electrolytic copper; gastight crimped; acc. to DIN 46228, Part 4/09.90; red	<a href="http://www.wago.com/216-243">www.wago.com/216-243</a>
	<b>Item no.: 216-244</b> Ferrule; Sleeve for 1.5 mm <sup>2</sup> / AWG 16; insulated; electro-tin plated; electrolytic copper; gastight crimped; acc. to DIN 46228, Part 4/09.90; black	<a href="http://www.wago.com/216-244">www.wago.com/216-244</a>
<b>tools</b>		
	<b>Item no.: 210-720</b> Operating tool; Blade: 3.5 x 0.5 mm; with a partially insulated shaft	<a href="http://www.wago.com/210-720">www.wago.com/210-720</a>
<b>Jumper</b>		
	<b>Item no.: 281-482</b> Comb-style jumper bar; insulated; 2-way; IN = IN terminal block; gray	<a href="http://www.wago.com/281-482">www.wago.com/281-482</a>
	<b>Item no.: 859-402</b> Push-in type jumper bar; 2-way; Nominal current 18 A; insulated; light gray	<a href="http://www.wago.com/859-402">www.wago.com/859-402</a>
	<b>Item no.: 859-402/000-005</b> Push-in type jumper bar; 2-way; Nominal current 18 A; insulated; red	<a href="http://www.wago.com/859-402/000-005">www.wago.com/859-402/000-005</a>
	<b>Item no.: 859-402/000-006</b> Push-in type jumper bar; 2-way; Nominal current 18 A; insulated; blue	<a href="http://www.wago.com/859-402/000-006">www.wago.com/859-402/000-006</a>







Subject to changes. Please also observe the further product documentation!

	<b>Item no.: 859-402/000-029</b> Push-in type jumper bar; 2-way; Nominal current 18 A; insulated; yellow	<a href="http://www.wago.com/859-402/000-029">www.wago.com/859-402/000-029</a>
	<b>Item no.: 859-403</b> Push-in type jumper bar; 3-way; Nominal current 18 A; insulated; light gray	<a href="http://www.wago.com/859-403">www.wago.com/859-403</a>
	<b>Item no.: 859-403/000-005</b> Push-in type jumper bar; 3-way; Nominal current 18 A; insulated; red	<a href="http://www.wago.com/859-403/000-005">www.wago.com/859-403/000-005</a>
	<b>Item no.: 859-403/000-006</b> Push-in type jumper bar; 3-way; Nominal current 18 A; insulated; blue	<a href="http://www.wago.com/859-403/000-006">www.wago.com/859-403/000-006</a>
	<b>Item no.: 859-403/000-029</b> Push-in type jumper bar; 3-way; Nominal current 18 A; insulated; yellow	<a href="http://www.wago.com/859-403/000-029">www.wago.com/859-403/000-029</a>
	<b>Item no.: 859-404</b> Push-in type jumper bar; 4-way; Nominal current 18 A; insulated; light gray	<a href="http://www.wago.com/859-404">www.wago.com/859-404</a>
	<b>Item no.: 859-404/000-005</b> Push-in type jumper bar; 4-way; Nominal current 18 A; insulated; red	<a href="http://www.wago.com/859-404/000-005">www.wago.com/859-404/000-005</a>
	<b>Item no.: 859-404/000-006</b> Push-in type jumper bar; 4-way; Nominal current 18 A; insulated; blue	<a href="http://www.wago.com/859-404/000-006">www.wago.com/859-404/000-006</a>
	<b>Item no.: 859-404/000-029</b> Push-in type jumper bar; 4-way; Nominal current 18 A; insulated; yellow	<a href="http://www.wago.com/859-404/000-029">www.wago.com/859-404/000-029</a>
	<b>Item no.: 859-405</b> Push-in type jumper bar; 5-way; Nominal current 18 A; insulated; light gray	<a href="http://www.wago.com/859-405">www.wago.com/859-405</a>
	<b>Item no.: 859-405/000-005</b> Push-in type jumper bar; 5-way; Nominal current 18 A; insulated; red	<a href="http://www.wago.com/859-405/000-005">www.wago.com/859-405/000-005</a>
	<b>Item no.: 859-405/000-006</b> Push-in type jumper bar; 5-way; Nominal current 18 A; insulated; blue	<a href="http://www.wago.com/859-405/000-006">www.wago.com/859-405/000-006</a>
	<b>Item no.: 859-405/000-029</b> Push-in type jumper bar; 5-way; Nominal current 18 A; insulated; yellow	<a href="http://www.wago.com/859-405/000-029">www.wago.com/859-405/000-029</a>
	<b>Item no.: 859-406</b> Push-in type jumper bar; 6-way; Nominal current 18 A; insulated; light gray	<a href="http://www.wago.com/859-406">www.wago.com/859-406</a>

Subject to changes. Please also observe the further product documentation!

	<b>Item no.: 859-406/000-005</b> Push-in type jumper bar; 6-way; Nominal current 18 A; insulated; red	<a href="http://www.wago.com/859-406/000-005">www.wago.com/859-406/000-005</a>
	<b>Item no.: 859-406/000-006</b> Push-in type jumper bar; 6-way; Nominal current 18 A; insulated; blue	<a href="http://www.wago.com/859-406/000-006">www.wago.com/859-406/000-006</a>
	<b>Item no.: 859-406/000-029</b> Push-in type jumper bar; 6-way; Nominal current 18 A; insulated; yellow	<a href="http://www.wago.com/859-406/000-029">www.wago.com/859-406/000-029</a>
	<b>Item no.: 859-407</b> Push-in type jumper bar; 7-way; Nominal current 18 A; insulated; light gray	<a href="http://www.wago.com/859-407">www.wago.com/859-407</a>
	<b>Item no.: 859-407/000-005</b> Push-in type jumper bar; 7-way; Nominal current 18 A; insulated; red	<a href="http://www.wago.com/859-407/000-005">www.wago.com/859-407/000-005</a>
	<b>Item no.: 859-407/000-006</b> Push-in type jumper bar; 7-way; Nominal current 18 A; insulated; blue	<a href="http://www.wago.com/859-407/000-006">www.wago.com/859-407/000-006</a>
	<b>Item no.: 859-407/000-029</b> Push-in type jumper bar; 7-way; Nominal current 18 A; insulated; yellow	<a href="http://www.wago.com/859-407/000-029">www.wago.com/859-407/000-029</a>
	<b>Item no.: 859-408</b> Push-in type jumper bar; 8-way; Nominal current 18 A; insulated; light gray	<a href="http://www.wago.com/859-408">www.wago.com/859-408</a>
	<b>Item no.: 859-408/000-005</b> Push-in type jumper bar; 8-way; Nominal current 18 A; insulated; red	<a href="http://www.wago.com/859-408/000-005">www.wago.com/859-408/000-005</a>
	<b>Item no.: 859-408/000-006</b> Push-in type jumper bar; 8-way; Nominal current 18 A; insulated; blue	<a href="http://www.wago.com/859-408/000-006">www.wago.com/859-408/000-006</a>
	<b>Item no.: 859-408/000-029</b> Push-in type jumper bar; 8-way; Nominal current 18 A; insulated; yellow	<a href="http://www.wago.com/859-408/000-029">www.wago.com/859-408/000-029</a>
	<b>Item no.: 859-409</b> Push-in type jumper bar; 9-way; Nominal current 18 A; insulated; light gray	<a href="http://www.wago.com/859-409">www.wago.com/859-409</a>
	<b>Item no.: 859-409/000-005</b> Push-in type jumper bar; 9-way; Nominal current 18 A; insulated; red	<a href="http://www.wago.com/859-409/000-005">www.wago.com/859-409/000-005</a>
	<b>Item no.: 859-409/000-006</b> Push-in type jumper bar; 9-way; Nominal current 18 A; insulated; blue	<a href="http://www.wago.com/859-409/000-006">www.wago.com/859-409/000-006</a>

Subject to changes. Please also observe the further product documentation!

	<b>Item no.: 859-409/000-029</b> Push-in type jumper bar; 9-way; Nominal current 18 A; insulated; yellow	<a href="http://www.wago.com/859-409/000-029">www.wago.com/859-409/000-029</a>
	<b>Item no.: 859-410</b> Push-in type jumper bar; 10-way; Nominal current 18 A; insulated; light gray	<a href="http://www.wago.com/859-410">www.wago.com/859-410</a>
	<b>Item no.: 859-410/000-005</b> Push-in type jumper bar; 10-way; Nominal current 18 A; insulated; red	<a href="http://www.wago.com/859-410/000-005">www.wago.com/859-410/000-005</a>
	<b>Item no.: 859-410/000-006</b> Push-in type jumper bar; 10-way; Nominal current 18 A; insulated; blue	<a href="http://www.wago.com/859-410/000-006">www.wago.com/859-410/000-006</a>
	<b>Item no.: 859-410/000-029</b> Push-in type jumper bar; 10-way; Nominal current 18 A; insulated; yellow	<a href="http://www.wago.com/859-410/000-029">www.wago.com/859-410/000-029</a>
<b>General accessories</b>		
	<b>Item no.: 209-184</b> Protection cover; transparent	<a href="http://www.wago.com/209-184">www.wago.com/209-184</a>
	<b>Item no.: 857-155</b> Basic relay; Nominal input voltage: 60 VDC; 1 changeover contact; Limiting continuous current: 6 A; Module width: 5 mm; Module height: 15 mm	<a href="http://www.wago.com/857-155">www.wago.com/857-155</a>

## Downloads

### Documentation

#### Bid Text

857-358 GAEB X81 - Datei	Feb 19, 2019	xml 4.8 kB	Download
857-358 GAEB docx - Datei	Feb 20, 2019	docx 17.0 kB	Download

#### Instruction Leaflet

Relaisbaustein mit steckbarem Kleinschaltrelais 1 Wechsler (1u) Eingangsnennspannung AC/DC 230 V		pdf 2.4 MB	Download
Elektromechanical and Solid-State Relays/Optocouplers	V 1.4.0 Oct 15, 2019	pdf 2.4 MB	Download

#### Additional Information

Disposal; Electrical and electronic equipment, Packaging	V 1.0.0	pdf	Download
--	---------	-----	----------

Subject to changes. Please also observe the further product documentation!

---

Step Datei Serie 857-03xx	1.0 Jun 20, 2011	ifc 299.3 kB	Download
---------------------------	---------------------	-----------------	----------

---

## CAD/CAE-Data

### CAD data

---

2D/3D Models 857-358	URL	Download
----------------------	-----	----------

---

### CAE data

---

EPLAN Data Portal 857-358	URL	Download
---------------------------	-----	----------

---

---

WSCAD Universe 857-358	URL	Download
------------------------	-----	----------

---

## Installation Notes

### Inserting a conductor

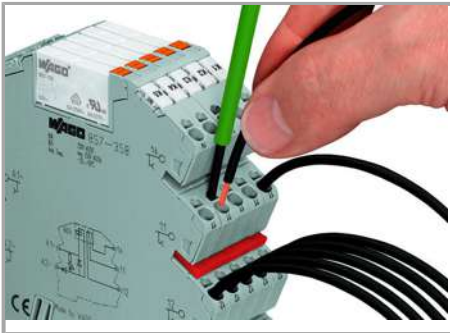

### Connection of conductor

### Jumpered

Subject to changes. Please also observe the further product documentation!

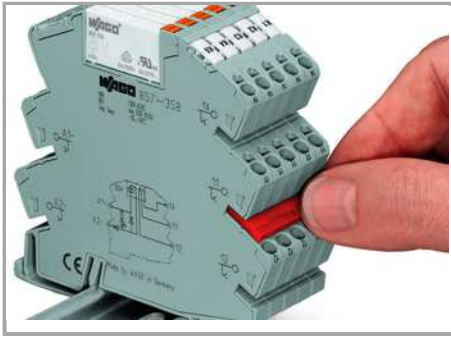

Easy commoning using adjacent jumpers

### Marking



Marking using WMB Multi markers

### Installation



Operation of the relay ejector

Subject to changes. Please also observe the further product documentation!