

**Data sheet | Item number: 857-369**

Relay module; Nominal input voltage: 24 ... 230 V AC/DC; 1 changeover contact; Limiting continuous current: 6 A; with gold contacts; Yellow status indicator; Module width: 6 mm

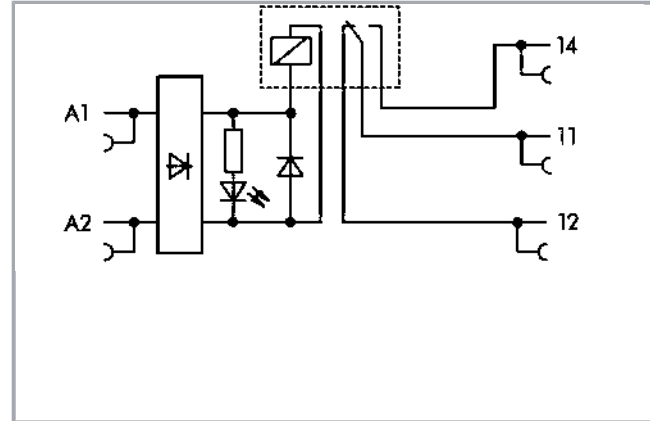

[www.wago.com/857-369](http://www.wago.com/857-369)

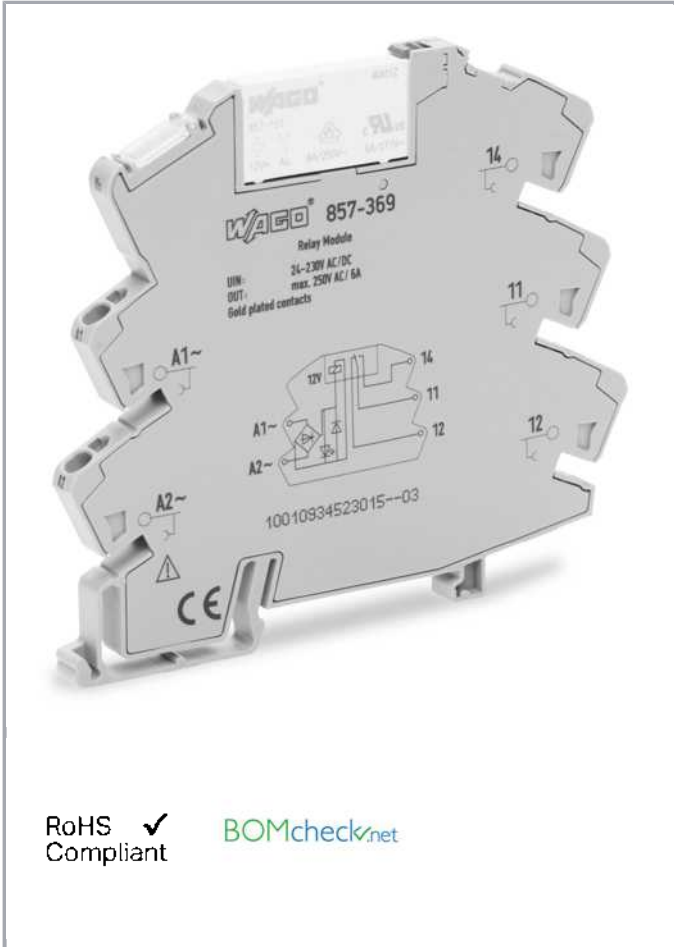

RoHS  Compliant

[BOMcheck.net](http://BOMcheck.net)

Subject to changes. Please also observe the further product documentation!

WAGO Kontakttechnik GmbH & Co. KG  
Hansastr. 27  
32423 Minden  
Phone: +49571 887-0 | Fax: +49571 887-169  
Email: [info.de@wago.com](mailto:info.de@wago.com) | Web: [www.wago.com](http://www.wago.com)

Do you have any questions about our products?  
We are always happy to take your call at +49 (571) 887-44222.

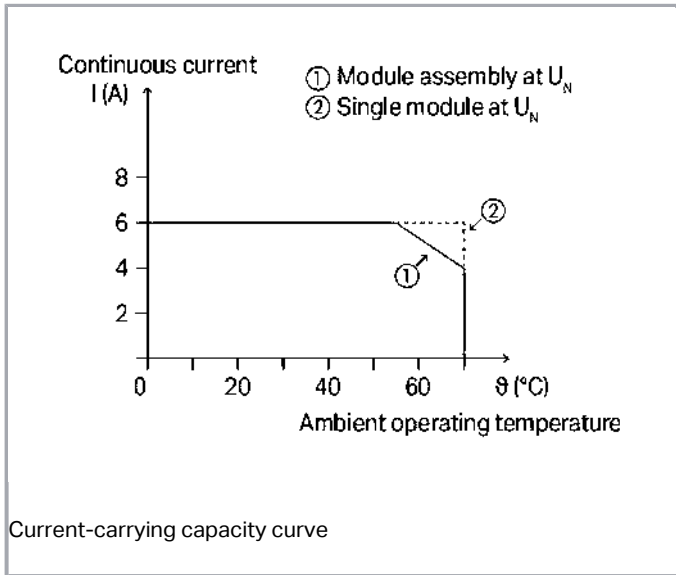

Current-carrying capacity curve

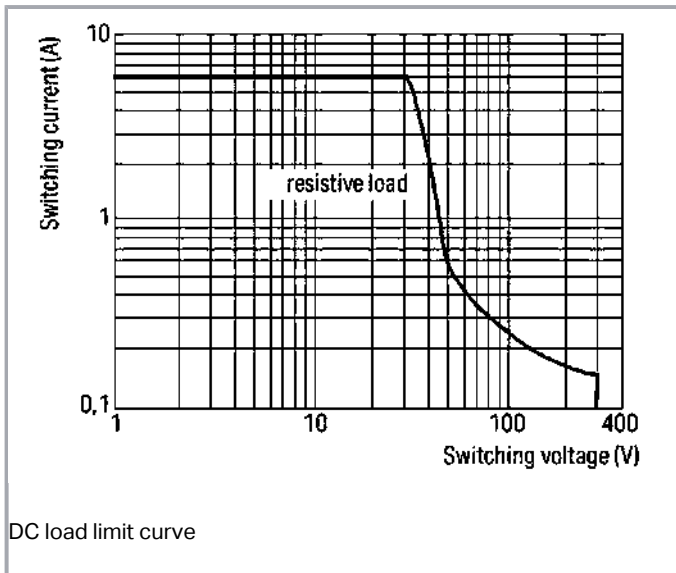
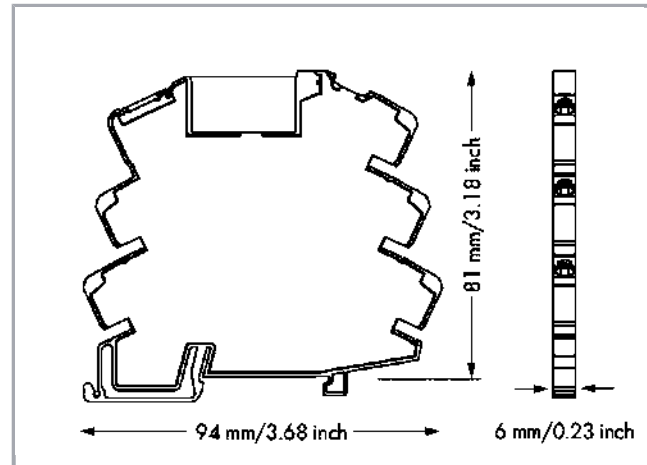

DC load limit curve

## Item description

### Note:

- To prevent damaging the gold layer, 30 VDC switching voltages and 50 mA currents must not be exceeded. Higher switching power eventually evaporates the gold layer. The resulting deposits in the housing may reduce service life.
- To protect the relay coils and contacts, inductive loads must be dampened with an effective protection circuit.

Subject to changes. Please also observe the further product documentation!



## Data

### Technical Data

#### Control circuit

Nominal input voltage $U_N$	AC/DC 24 ... 230 V
Input voltage range	-30 ... +10 %
Nominal input current at $U_N$	3,5 mA (230 VAC); 20 mA (24 VDC)

#### Load circuit:

Number of changeover/switchover contacts	1
Contact material (relay)	AgNi + Au
Limiting continuous current	6 A
Max. make current (resistive)	(AC) 20 A / 0,02 s
Max. switching voltage	AC 250 V
Max. switching power (resistive)	AC 1500 VA; DC (see load limit curve)
Switching capacity	AC-15: 3 A / AC 250 V; DC-13: 2 A / DC 24 V
Recommended minimum load	1 V / 1 mA / 1 mW
Pull-in time (typ.)	15 ms
Drop-out time (typ.)	25 ms
Bounce time (typ.)	3.5 ms
Electrical life (N.O.; resistive load; 23 °C)	$50 \times 10^3$ switching operations
Mechanical life	$5 \times 10^6$ switching operations
Max. switching load with load/without load	$6 \text{ min}^{-1}$ / $60 \text{ min}^{-1}$

#### Signaling

Status indication	Yellow LED
-------------------	------------

#### Safety and protection:

Rated voltage	250 V
Rated impulse voltage	4 kV
Pollution degree	2
Dielectric strength, control/load circuit (AC, 1 min)	4 kVrms
Dielectric strength open contact (AC, 1 min)	1 kVrms

Subject to changes. Please also observe the further product documentation!

WAGO Kontakttechnik GmbH & Co. KG  
 Hansastr. 27  
 32423 Minden  
 Phone: +49571 887-0 | Fax: +49571 887-169  
 Email: [info.de@wago.com](mailto:info.de@wago.com) | Web: [www.wago.com](http://www.wago.com)

Do you have any questions about our products?  
 We are always happy to take your call at +49 (571) 887-44222.

Protection class	IP20
------------------	------

### Connection data

Connection technology	Push-in CAGE CLAMP®
Solid conductor	0,34 ... 2,5 mm <sup>2</sup> / 22 ... 14 AWG
Fine-stranded conductor	0,34 ... 2,5 mm <sup>2</sup> / 22 ... 14 AWG
Strip length	9 ... 10 mm / 0.35 ... 0.39 inch

### Geometrical Data

Width	6 mm / 0.236 inch
Height from upper-edge of DIN-35 rail	81 mm / 3.189 inch
Depth	94 mm / 3.701 inch

### Mechanical data

Type of mounting	DIN-35 rail
------------------	-------------

### Material Data

Fire load	0.011 MJ
Weight	31.9 g

### Environmental Requirements

Surrounding air (operating) temperature at U <sub>N</sub>	-40 ... 70 °C
Surrounding air (storage) temperature	-40 ... 70 °C
Processing temperature	-25 ... +50 °C

### Standards and specifications

Standards/specifications	EN 50121-3-2; EN 61010-2-201; EN 61810-1; EN 61373; EN 61000-6-2; EN 61000-6-3; EN 50121-3; UL 508
--------------------------	--

### Elementary relay

WAGO elementary relay	857-151
-----------------------	---------

### Commercial data

Packaging type	BOX
Country of origin	DE

Subject to changes. Please also observe the further product documentation!

GTIN	4050821854241
Customs Tariff No.	85364900990

## Approvals / Certificates

### UL-Approvals

Logo	Approval	Additional Approval Text	Certificate name
	UL UL International Netherlands B.V. (ORDINARY LOCATIONS)	UL 508	E175199 Sec.4





## Counterpart

## Compatible products

### tools

	<b>Item no.: 210-720</b> Operating tool; Blade: 3.5 x 0.5 mm; with a partially insulated shaft	<a href="http://www.wago.com/210-720">www.wago.com/210-720</a>
--	---	--

### ferrule















	<b>Item no.: 216-241</b> Ferrule; Sleeve for 0.5 mm <sup>2</sup> / 20 AWG; insulated; electro-tin plated; electrolytic copper; gastight crimped; acc. to DIN 46228, Part 4/09.90; white	<a href="http://www.wago.com/216-241">www.wago.com/216-241</a>
	<b>Item no.: 216-242</b> Ferrule; Sleeve for 0.75 mm <sup>2</sup> / 18 AWG; insulated; electro-tin plated; electrolytic copper; gastight crimped; acc. to DIN 46228, Part 4/09.90; gray	<a href="http://www.wago.com/216-242">www.wago.com/216-242</a>
	<b>Item no.: 216-243</b> Ferrule; Sleeve for 1 mm <sup>2</sup> / AWG 18; insulated; electro-tin plated; electrolytic copper; gastight crimped; acc. to DIN 46228, Part 4/09.90; red	<a href="http://www.wago.com/216-243">www.wago.com/216-243</a>
	<b>Item no.: 216-244</b> Ferrule; Sleeve for 1.5 mm <sup>2</sup> / AWG 16; insulated; electro-tin plated; electrolytic copper; gastight crimped; acc. to DIN 46228, Part 4/09.90; black	<a href="http://www.wago.com/216-244">www.wago.com/216-244</a>

### General accessories















	<b>Item no.: 209-184</b> Protection cover; transparent	<a href="http://www.wago.com/209-184">www.wago.com/209-184</a>
--	---	--

### Jumper















Subject to changes. Please also observe the further product documentation!

	<b>Item no.: 281-482</b> Comb-style jumper bar; insulated; 2-way; IN = IN terminal block; gray	<a href="http://www.wago.com/281-482">www.wago.com/281-482</a>
	<b>Item no.: 859-402</b> Push-in type jumper bar; 2-way; Nominal current 18 A; insulated; light gray	<a href="http://www.wago.com/859-402">www.wago.com/859-402</a>
	<b>Item no.: 859-402/000-005</b> Push-in type jumper bar; 2-way; Nominal current 18 A; insulated; red	<a href="http://www.wago.com/859-402/000-005">www.wago.com/859-402/000-005</a>
	<b>Item no.: 859-402/000-006</b> Push-in type jumper bar; 2-way; Nominal current 18 A; insulated; blue	<a href="http://www.wago.com/859-402/000-006">www.wago.com/859-402/000-006</a>
	<b>Item no.: 859-402/000-029</b> Push-in type jumper bar; 2-way; Nominal current 18 A; insulated; yellow	<a href="http://www.wago.com/859-402/000-029">www.wago.com/859-402/000-029</a>
	<b>Item no.: 859-403</b> Push-in type jumper bar; 3-way; Nominal current 18 A; insulated; light gray	<a href="http://www.wago.com/859-403">www.wago.com/859-403</a>
	<b>Item no.: 859-403/000-005</b> Push-in type jumper bar; 3-way; Nominal current 18 A; insulated; red	<a href="http://www.wago.com/859-403/000-005">www.wago.com/859-403/000-005</a>
	<b>Item no.: 859-403/000-006</b> Push-in type jumper bar; 3-way; Nominal current 18 A; insulated; blue	<a href="http://www.wago.com/859-403/000-006">www.wago.com/859-403/000-006</a>
	<b>Item no.: 859-403/000-029</b> Push-in type jumper bar; 3-way; Nominal current 18 A; insulated; yellow	<a href="http://www.wago.com/859-403/000-029">www.wago.com/859-403/000-029</a>
	<b>Item no.: 859-404</b> Push-in type jumper bar; 4-way; Nominal current 18 A; insulated; light gray	<a href="http://www.wago.com/859-404">www.wago.com/859-404</a>
	<b>Item no.: 859-404/000-005</b> Push-in type jumper bar; 4-way; Nominal current 18 A; insulated; red	<a href="http://www.wago.com/859-404/000-005">www.wago.com/859-404/000-005</a>
	<b>Item no.: 859-404/000-006</b> Push-in type jumper bar; 4-way; Nominal current 18 A; insulated; blue	<a href="http://www.wago.com/859-404/000-006">www.wago.com/859-404/000-006</a>
	<b>Item no.: 859-404/000-029</b> Push-in type jumper bar; 4-way; Nominal current 18 A; insulated; yellow	<a href="http://www.wago.com/859-404/000-029">www.wago.com/859-404/000-029</a>
	<b>Item no.: 859-405</b> Push-in type jumper bar; 5-way; Nominal current 18 A; insulated; light gray	<a href="http://www.wago.com/859-405">www.wago.com/859-405</a>
	<b>Item no.: 859-405/000-005</b> Push-in type jumper bar; 5-way; Nominal current 18 A; insulated; red	<a href="http://www.wago.com/859-405/000-005">www.wago.com/859-405/000-005</a>

Subject to changes. Please also observe the further product documentation!















	<b>Item no.: 859-405/000-006</b> Push-in type jumper bar; 5-way; Nominal current 18 A; insulated; blue	<a href="http://www.wago.com/859-405/000-006">www.wago.com/859-405/000-006</a>
	<b>Item no.: 859-405/000-029</b> Push-in type jumper bar; 5-way; Nominal current 18 A; insulated; yellow	<a href="http://www.wago.com/859-405/000-029">www.wago.com/859-405/000-029</a>
	<b>Item no.: 859-406</b> Push-in type jumper bar; 6-way; Nominal current 18 A; insulated; light gray	<a href="http://www.wago.com/859-406">www.wago.com/859-406</a>
	<b>Item no.: 859-406/000-005</b> Push-in type jumper bar; 6-way; Nominal current 18 A; insulated; red	<a href="http://www.wago.com/859-406/000-005">www.wago.com/859-406/000-005</a>
	<b>Item no.: 859-406/000-006</b> Push-in type jumper bar; 6-way; Nominal current 18 A; insulated; blue	<a href="http://www.wago.com/859-406/000-006">www.wago.com/859-406/000-006</a>
	<b>Item no.: 859-406/000-029</b> Push-in type jumper bar; 6-way; Nominal current 18 A; insulated; yellow	<a href="http://www.wago.com/859-406/000-029">www.wago.com/859-406/000-029</a>
	<b>Item no.: 859-407</b> Push-in type jumper bar; 7-way; Nominal current 18 A; insulated; light gray	<a href="http://www.wago.com/859-407">www.wago.com/859-407</a>
	<b>Item no.: 859-407/000-005</b> Push-in type jumper bar; 7-way; Nominal current 18 A; insulated; red	<a href="http://www.wago.com/859-407/000-005">www.wago.com/859-407/000-005</a>
	<b>Item no.: 859-407/000-006</b> Push-in type jumper bar; 7-way; Nominal current 18 A; insulated; blue	<a href="http://www.wago.com/859-407/000-006">www.wago.com/859-407/000-006</a>
	<b>Item no.: 859-407/000-029</b> Push-in type jumper bar; 7-way; Nominal current 18 A; insulated; yellow	<a href="http://www.wago.com/859-407/000-029">www.wago.com/859-407/000-029</a>
	<b>Item no.: 859-408</b> Push-in type jumper bar; 8-way; Nominal current 18 A; insulated; light gray	<a href="http://www.wago.com/859-408">www.wago.com/859-408</a>
	<b>Item no.: 859-408/000-005</b> Push-in type jumper bar; 8-way; Nominal current 18 A; insulated; red	<a href="http://www.wago.com/859-408/000-005">www.wago.com/859-408/000-005</a>
	<b>Item no.: 859-408/000-006</b> Push-in type jumper bar; 8-way; Nominal current 18 A; insulated; blue	<a href="http://www.wago.com/859-408/000-006">www.wago.com/859-408/000-006</a>
	<b>Item no.: 859-408/000-029</b> Push-in type jumper bar; 8-way; Nominal current 18 A; insulated; yellow	<a href="http://www.wago.com/859-408/000-029">www.wago.com/859-408/000-029</a>

Subject to changes. Please also observe the further product documentation!













	<b>Item no.: 859-409</b> Push-in type jumper bar; 9-way; Nominal current 18 A; insulated; light gray	<a href="http://www.wago.com/859-409">www.wago.com/859-409</a>
	<b>Item no.: 859-409/000-005</b> Push-in type jumper bar; 9-way; Nominal current 18 A; insulated; red	<a href="http://www.wago.com/859-409/000-005">www.wago.com/859-409/000-005</a>
	<b>Item no.: 859-409/000-006</b> Push-in type jumper bar; 9-way; Nominal current 18 A; insulated; blue	<a href="http://www.wago.com/859-409/000-006">www.wago.com/859-409/000-006</a>
	<b>Item no.: 859-409/000-029</b> Push-in type jumper bar; 9-way; Nominal current 18 A; insulated; yellow	<a href="http://www.wago.com/859-409/000-029">www.wago.com/859-409/000-029</a>
	<b>Item no.: 859-410</b> Push-in type jumper bar; 10-way; Nominal current 18 A; insulated; light gray	<a href="http://www.wago.com/859-410">www.wago.com/859-410</a>
	<b>Item no.: 859-410/000-005</b> Push-in type jumper bar; 10-way; Nominal current 18 A; insulated; red	<a href="http://www.wago.com/859-410/000-005">www.wago.com/859-410/000-005</a>
	<b>Item no.: 859-410/000-006</b> Push-in type jumper bar; 10-way; Nominal current 18 A; insulated; blue	<a href="http://www.wago.com/859-410/000-006">www.wago.com/859-410/000-006</a>
	<b>Item no.: 859-410/000-029</b> Push-in type jumper bar; 10-way; Nominal current 18 A; insulated; yellow	<a href="http://www.wago.com/859-410/000-029">www.wago.com/859-410/000-029</a>
<b>Marking accessories</b>		
	<b>Item no.: 2009-110</b> Marking strips; on reel; not stretchable; plain; snap-on type; white	<a href="http://www.wago.com/2009-110">www.wago.com/2009-110</a>
	<b>Item no.: 2009-115</b> WMB-Inline; for Smart Printer; 1500 pieces on roll; stretchable 5 - 5.2 mm; plain; snap-on type; white	<a href="http://www.wago.com/2009-115">www.wago.com/2009-115</a>
	<b>Item no.: 2009-115/000-002</b> WMB-Inline; for Smart Printer; 1500 pieces on roll; stretchable 5 - 5.2 mm; plain; snap-on type; yellow	<a href="http://www.wago.com/2009-115/000-002">www.wago.com/2009-115/000-002</a>
	<b>Item no.: 2009-115/000-006</b> WMB-Inline; for Smart Printer; 1500 pieces on roll; stretchable 5 - 5.2 mm; plain; snap-on type; blue	<a href="http://www.wago.com/2009-115/000-006">www.wago.com/2009-115/000-006</a>
	<b>Item no.: 2009-115/000-007</b> WMB-Inline; for Smart Printer; 1500 pieces on roll; stretchable 5 - 5.2 mm; plain; snap-on type; gray	<a href="http://www.wago.com/2009-115/000-007">www.wago.com/2009-115/000-007</a>
	<b>Item no.: 2009-115/000-012</b> WMB-Inline; for Smart Printer; 1500 pieces on roll; stretchable 5 - 5.2 mm; plain; snap-on type; orange	<a href="http://www.wago.com/2009-115/000-012">www.wago.com/2009-115/000-012</a>

Subject to changes. Please also observe the further product documentation!















	<b>Item no.: 2009-115/000-017</b> WMB-Inline; for Smart Printer; 1500 pieces on roll; stretchable 5 - 5.2 mm; plain; snap-on type; light green	<a href="http://www.wago.com/2009-115/000-017">www.wago.com/2009-115/000-017</a>
	<b>Item no.: 2009-115/000-023</b> WMB-Inline; for Smart Printer; 1500 pieces on roll; stretchable 5 - 5.2 mm; plain; snap-on type; green	<a href="http://www.wago.com/2009-115/000-023">www.wago.com/2009-115/000-023</a>
	<b>Item no.: 2009-115/000-024</b> WMB-Inline; for Smart Printer; 1500 pieces on roll; stretchable 5 - 5.2 mm; plain; snap-on type; violet	<a href="http://www.wago.com/2009-115/000-024">www.wago.com/2009-115/000-024</a>
	<b>Item no.: 209-128</b> Adaptor; gray	<a href="http://www.wago.com/209-128">www.wago.com/209-128</a>
	<b>Item no.: 209-183</b> Marker card; white	<a href="http://www.wago.com/209-183">www.wago.com/209-183</a>
	<b>Item no.: 210-110</b> Fiber-tip pen	<a href="http://www.wago.com/210-110">www.wago.com/210-110</a>
	<b>Item no.: 249-105</b> Group marker carrier; gray	<a href="http://www.wago.com/249-105">www.wago.com/249-105</a>
	<b>Item no.: 793-501</b> WMB marking card; as card; not stretchable; plain; snap-on type; white	<a href="http://www.wago.com/793-501">www.wago.com/793-501</a>
	<b>Item no.: 793-501/000-002</b> WMB marking card; as card; not stretchable; plain; snap-on type; yellow	<a href="http://www.wago.com/793-501/000-002">www.wago.com/793-501/000-002</a>
	<b>Item no.: 793-501/000-005</b> WMB marking card; as card; not stretchable; plain; snap-on type; red	<a href="http://www.wago.com/793-501/000-005">www.wago.com/793-501/000-005</a>
	<b>Item no.: 793-501/000-006</b> WMB marking card; as card; not stretchable; plain; snap-on type; blue	<a href="http://www.wago.com/793-501/000-006">www.wago.com/793-501/000-006</a>
	<b>Item no.: 793-501/000-007</b> WMB marking card; as card; not stretchable; plain; snap-on type; gray	<a href="http://www.wago.com/793-501/000-007">www.wago.com/793-501/000-007</a>
	<b>Item no.: 793-501/000-012</b> WMB marking card; as card; not stretchable; plain; snap-on type; orange	<a href="http://www.wago.com/793-501/000-012">www.wago.com/793-501/000-012</a>
	<b>Item no.: 793-501/000-017</b> WMB marking card; as card; not stretchable; plain; snap-on type; light green	<a href="http://www.wago.com/793-501/000-017">www.wago.com/793-501/000-017</a>
	<b>Item no.: 793-501/000-023</b> WMB marking card; as card; not stretchable; plain; snap-on type; green	<a href="http://www.wago.com/793-501/000-023">www.wago.com/793-501/000-023</a>















Subject to changes. Please also observe the further product documentation!

	<b>Item no.: 793-501/000-024</b> WMB marking card; as card; not stretchable; plain; snap-on type; violet	<a href="http://www.wago.com/793-501/000-024">www.wago.com/793-501/000-024</a>
	<b>Item no.: 793-502</b> WMB marking card; as card; MARKED; 1 ... 10 (10x); not stretchable; Horizontal marking; snap-on type; white	<a href="http://www.wago.com/793-502">www.wago.com/793-502</a>
	<b>Item no.: 793-502/000-002</b> WMB marking card; as card; MARKED; 1 ... 10 (10x); not stretchable; Horizontal marking; snap-on type; yellow	<a href="http://www.wago.com/793-502/000-002">www.wago.com/793-502/000-002</a>
	<b>Item no.: 793-502/000-005</b> WMB marking card; as card; MARKED; 1 ... 10 (10x); not stretchable; Horizontal marking; snap-on type; red	<a href="http://www.wago.com/793-502/000-005">www.wago.com/793-502/000-005</a>
	<b>Item no.: 793-502/000-006</b> WMB marking card; as card; MARKED; 1 ... 10 (10x); not stretchable; Horizontal marking; snap-on type; blue	<a href="http://www.wago.com/793-502/000-006">www.wago.com/793-502/000-006</a>
	<b>Item no.: 793-502/000-007</b> WMB marking card; as card; MARKED; 1 ... 10 (10x); not stretchable; Horizontal marking; snap-on type; gray	<a href="http://www.wago.com/793-502/000-007">www.wago.com/793-502/000-007</a>
	<b>Item no.: 793-502/000-012</b> WMB marking card; as card; MARKED; 1 ... 10 (10x); not stretchable; Horizontal marking; snap-on type; orange	<a href="http://www.wago.com/793-502/000-012">www.wago.com/793-502/000-012</a>
	<b>Item no.: 793-502/000-017</b> WMB marking card; as card; MARKED; 1 ... 10 (10x); not stretchable; Horizontal marking; snap-on type; light green	<a href="http://www.wago.com/793-502/000-017">www.wago.com/793-502/000-017</a>
	<b>Item no.: 793-502/000-023</b> WMB marking card; as card; MARKED; 1 ... 10 (10x); not stretchable; Horizontal marking; snap-on type; green	<a href="http://www.wago.com/793-502/000-023">www.wago.com/793-502/000-023</a>
	<b>Item no.: 793-502/000-024</b> WMB marking card; as card; MARKED; 1 ... 10 (10x); not stretchable; Horizontal marking; snap-on type; violet	<a href="http://www.wago.com/793-502/000-024">www.wago.com/793-502/000-024</a>
	<b>Item no.: 793-503</b> WMB marking card; as card; MARKED; 11 ... 20 (10x); not stretchable; Horizontal marking; snap-on type; white	<a href="http://www.wago.com/793-503">www.wago.com/793-503</a>
	<b>Item no.: 793-503/000-002</b> WMB marking card; as card; MARKED; 11 ... 20 (10x); not stretchable; Horizontal marking; snap-on type; yellow	<a href="http://www.wago.com/793-503/000-002">www.wago.com/793-503/000-002</a>
	<b>Item no.: 793-503/000-005</b> WMB marking card; as card; MARKED; 11 ... 20 (10x); not stretchable; Horizontal marking; snap-on type; red	<a href="http://www.wago.com/793-503/000-005">www.wago.com/793-503/000-005</a>
	<b>Item no.: 793-503/000-006</b>	













Subject to changes. Please also observe the further product documentation!

	WMB marking card; as card; MARKED; 11 ... 20 (10x); not stretchable; Horizontal marking; snap-on type; blue	<a href="http://www.wago.com/793-503/000-006">www.wago.com/793-503/000-006</a>
	<b>Item no.: 793-503/000-007</b> WMB marking card; as card; MARKED; 11 ... 20 (10x); not stretchable; Horizontal marking; snap-on type; gray	<a href="http://www.wago.com/793-503/000-007">www.wago.com/793-503/000-007</a>
	<b>Item no.: 793-503/000-012</b> WMB marking card; as card; MARKED; 11 ... 20 (10x); not stretchable; Horizontal marking; snap-on type; orange	<a href="http://www.wago.com/793-503/000-012">www.wago.com/793-503/000-012</a>
	<b>Item no.: 793-503/000-017</b> WMB marking card; as card; MARKED; 11 ... 20 (10x); not stretchable; Horizontal marking; snap-on type; light green	<a href="http://www.wago.com/793-503/000-017">www.wago.com/793-503/000-017</a>
	<b>Item no.: 793-503/000-023</b> WMB marking card; as card; MARKED; 11 ... 20 (10x); not stretchable; Horizontal marking; snap-on type; green	<a href="http://www.wago.com/793-503/000-023">www.wago.com/793-503/000-023</a>
	<b>Item no.: 793-503/000-024</b> WMB marking card; as card; MARKED; 11 ... 20 (10x); not stretchable; Horizontal marking; snap-on type; violet	<a href="http://www.wago.com/793-503/000-024">www.wago.com/793-503/000-024</a>
	<b>Item no.: 793-504</b> WMB marking card; as card; MARKED; 21 ... 30 (10x); not stretchable; Horizontal marking; snap-on type; white	<a href="http://www.wago.com/793-504">www.wago.com/793-504</a>
	<b>Item no.: 793-504/000-002</b> WMB marking card; as card; MARKED; 21 ... 30 (10x); not stretchable; Horizontal marking; snap-on type; yellow	<a href="http://www.wago.com/793-504/000-002">www.wago.com/793-504/000-002</a>
	<b>Item no.: 793-504/000-005</b> WMB marking card; as card; MARKED; 21 ... 30 (10x); not stretchable; Horizontal marking; snap-on type; red	<a href="http://www.wago.com/793-504/000-005">www.wago.com/793-504/000-005</a>
	<b>Item no.: 793-504/000-006</b> WMB marking card; as card; MARKED; 21 ... 30 (10x); not stretchable; Horizontal marking; snap-on type; blue	<a href="http://www.wago.com/793-504/000-006">www.wago.com/793-504/000-006</a>
	<b>Item no.: 793-504/000-012</b> WMB marking card; as card; MARKED; 21 ... 30 (10x); not stretchable; Horizontal marking; snap-on type; orange	<a href="http://www.wago.com/793-504/000-012">www.wago.com/793-504/000-012</a>
	<b>Item no.: 793-504/000-017</b> WMB marking card; as card; MARKED; 21 ... 30 (10x); not stretchable; Horizontal marking; snap-on type; light green	<a href="http://www.wago.com/793-504/000-017">www.wago.com/793-504/000-017</a>
	<b>Item no.: 793-504/000-023</b> WMB marking card; as card; MARKED; 21 ... 30 (10x); not stretchable; Horizontal marking; snap-on type; green	<a href="http://www.wago.com/793-504/000-023">www.wago.com/793-504/000-023</a>
	<b>Item no.: 793-505</b> WMB marking card; as card; MARKED; 31 ... 40 (10x); not stretchable; Horizontal marking; snap-on type;	<a href="http://www.wago.com/793-505">www.wago.com/793-505</a>

Subject to changes. Please also observe the further product documentation!

	white	
	<b>Item no.: 793-505/000-005</b> WMB marking card; as card; MARKED; 31 ... 40 (10x); not stretchable; Horizontal marking; snap-on type; red	<a href="http://www.wago.com/793-505/000-005">www.wago.com/793-505/000-005</a>
	<b>Item no.: 793-505/000-006</b> WMB marking card; as card; MARKED; 31 ... 40 (10x); not stretchable; Horizontal marking; snap-on type; blue	<a href="http://www.wago.com/793-505/000-006">www.wago.com/793-505/000-006</a>
	<b>Item no.: 793-505/000-007</b> WMB marking card; as card; MARKED; 31 ... 40 (10x); not stretchable; Horizontal marking; snap-on type; gray	<a href="http://www.wago.com/793-505/000-007">www.wago.com/793-505/000-007</a>
	<b>Item no.: 793-505/000-012</b> WMB marking card; as card; MARKED; 31 ... 40 (10x); not stretchable; Horizontal marking; snap-on type; orange	<a href="http://www.wago.com/793-505/000-012">www.wago.com/793-505/000-012</a>
	<b>Item no.: 793-506</b> WMB marking card; as card; MARKED; 41 ... 50 (10x); not stretchable; Horizontal marking; snap-on type; white	<a href="http://www.wago.com/793-506">www.wago.com/793-506</a>
	<b>Item no.: 793-506/000-005</b> WMB marking card; as card; MARKED; 41 ... 50 (10x); not stretchable; Horizontal marking; snap-on type; red	<a href="http://www.wago.com/793-506/000-005">www.wago.com/793-506/000-005</a>
	<b>Item no.: 793-506/000-006</b> WMB marking card; as card; MARKED; 41 ... 50 (10x); not stretchable; Horizontal marking; snap-on type; blue	<a href="http://www.wago.com/793-506/000-006">www.wago.com/793-506/000-006</a>
	<b>Item no.: 793-506/000-012</b> WMB marking card; as card; MARKED; 41 ... 50 (10x); not stretchable; Horizontal marking; snap-on type; orange	<a href="http://www.wago.com/793-506/000-012">www.wago.com/793-506/000-012</a>
	<b>Item no.: 793-506/000-017</b> WMB marking card; as card; MARKED; 41 ... 50 (10x); not stretchable; Horizontal marking; snap-on type; light green	<a href="http://www.wago.com/793-506/000-017">www.wago.com/793-506/000-017</a>
	<b>Item no.: 793-5501</b> WMB marking card; as card; for terminal block width 5 - 17.5 mm; stretchable 5 - 5.2 mm; plain; snap-on type; white	<a href="http://www.wago.com/793-5501">www.wago.com/793-5501</a>
	<b>Item no.: 793-5501/000-002</b> WMB marking card; as card; for terminal block width 5 - 17.5 mm; stretchable 5 - 5.2 mm; plain; snap-on type; yellow	<a href="http://www.wago.com/793-5501/000-002">www.wago.com/793-5501/000-002</a>
	<b>Item no.: 793-5501/000-005</b> WMB marking card; as card; for terminal block width 5 - 17.5 mm; stretchable 5 - 5.2 mm; plain; snap-on type; red	<a href="http://www.wago.com/793-5501/000-005">www.wago.com/793-5501/000-005</a>
	<b>Item no.: 793-5501/000-006</b> WMB marking card; as card; for terminal block width 5 - 17.5 mm; stretchable 5 - 5.2 mm; plain; snap-on type; blue	<a href="http://www.wago.com/793-5501/000-006">www.wago.com/793-5501/000-006</a>

Subject to changes. Please also observe the further product documentation!

	<b>Item no.: 793-5501/000-007</b> WMB marking card; as card; for terminal block width 5 - 17.5 mm; stretchable 5 - 5.2 mm; plain; snap-on type; gray	<a href="http://www.wago.com/793-5501/000-007">www.wago.com/793-5501/000-007</a>
	<b>Item no.: 793-5501/000-012</b> WMB marking card; as card; for terminal block width 5 - 17.5 mm; stretchable 5 - 5.2 mm; plain; snap-on type; orange	<a href="http://www.wago.com/793-5501/000-012">www.wago.com/793-5501/000-012</a>
	<b>Item no.: 793-5501/000-014</b> WMB marking card; as card; for terminal block width 5 - 17.5 mm; stretchable 5 - 5.2 mm; plain; snap-on type; brown	<a href="http://www.wago.com/793-5501/000-014">www.wago.com/793-5501/000-014</a>
	<b>Item no.: 793-5501/000-017</b> WMB marking card; as card; for terminal block width 5 - 17.5 mm; stretchable 5 - 5.2 mm; plain; snap-on type; green	<a href="http://www.wago.com/793-5501/000-017">www.wago.com/793-5501/000-017</a>
	<b>Item no.: 793-5501/000-023</b> WMB marking card; as card; for terminal block width 5 - 17.5 mm; stretchable 5 - 5.2 mm; plain; snap-on type; light green	<a href="http://www.wago.com/793-5501/000-023">www.wago.com/793-5501/000-023</a>
	<b>Item no.: 793-5501/000-024</b> WMB marking card; as card; for terminal block width 5 - 17.5 mm; stretchable 5 - 5.2 mm; plain; snap-on type; violet	<a href="http://www.wago.com/793-5501/000-024">www.wago.com/793-5501/000-024</a>
	<b>Item no.: 793-566</b> WMB marking card; as card; MARKED; 1 ... 50 (2x); not stretchable; Horizontal marking; snap-on type; white	<a href="http://www.wago.com/793-566">www.wago.com/793-566</a>
	<b>Item no.: 793-566/000-002</b> WMB marking card; as card; MARKED; 1 ... 50 (2x); not stretchable; Horizontal marking; snap-on type; yellow	<a href="http://www.wago.com/793-566/000-002">www.wago.com/793-566/000-002</a>
	<b>Item no.: 793-566/000-005</b> WMB marking card; as card; MARKED; 1 ... 50 (2x); not stretchable; Horizontal marking; snap-on type; red	<a href="http://www.wago.com/793-566/000-005">www.wago.com/793-566/000-005</a>
	<b>Item no.: 793-566/000-006</b> WMB marking card; as card; MARKED; 1 ... 50 (2x); not stretchable; Horizontal marking; snap-on type; blue	<a href="http://www.wago.com/793-566/000-006">www.wago.com/793-566/000-006</a>
	<b>Item no.: 793-566/000-007</b> WMB marking card; as card; MARKED; 1 ... 50 (2x); not stretchable; Horizontal marking; snap-on type; gray	<a href="http://www.wago.com/793-566/000-007">www.wago.com/793-566/000-007</a>
	<b>Item no.: 793-566/000-012</b> WMB marking card; as card; MARKED; 1 ... 50 (2x); not stretchable; Horizontal marking; snap-on type; orange	<a href="http://www.wago.com/793-566/000-012">www.wago.com/793-566/000-012</a>
	<b>Item no.: 793-566/000-017</b> WMB marking card; as card; MARKED; 1 ... 50 (2x); not stretchable; Horizontal marking; snap-on type; light green	<a href="http://www.wago.com/793-566/000-017">www.wago.com/793-566/000-017</a>
	<b>Item no.: 793-566/000-023</b>	

Subject to changes. Please also observe the further product documentation!



WMB marking card; as card; MARKED; 1 ... 50 (2x); not stretchable; Horizontal marking; snap-on type; green

[www.wago.com/793-566/000-023](http://www.wago.com/793-566/000-023)



Item no.: 793-566/000-024

WMB marking card; as card; MARKED; 1 ... 50 (2x); not stretchable; Horizontal marking; snap-on type; violet

[www.wago.com/793-566/000-024](http://www.wago.com/793-566/000-024)

## Downloads

### Documentation

#### Bid Text

857-369 GAEB X81 - Datei	Feb 19, 2019	xml 5.6 kB	Download
857-369 GAEB docx - Datei	Feb 20, 2019	docx 17.3 kB	Download

#### Additional Information

Disposal; Electrical and electronic equipment, Packaging	V 1.0.0	pdf 265.8 kB	Download
Confirmation for use in railway applications, 857-359, 857-369		pdf 369.3 kB	Download

## CAD/CAE-Data

### CAD data

2D/3D Models 857-369	URL	Download
----------------------	-----	----------

### CAE data

EPLAN Data Portal 857-369	URL	Download
WSCAD Universe 857-369	URL	Download

## Installation Notes

### Inserting a conductor

Subject to changes. Please also observe the further product documentation!

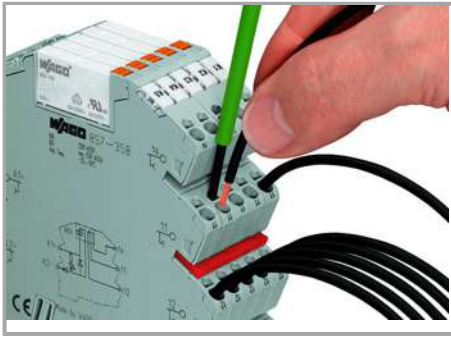

Connection of conductor

### Jumpered

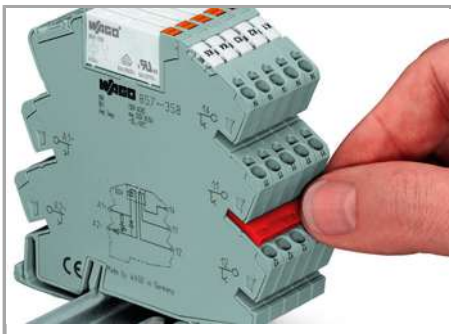

Easy commoning using adjacent jumpers

### Marking



Marking using WMB Multi markers

### Installation

Subject to changes. Please also observe the further product documentation!





Operation of the relay ejector

Subject to changes. Please also observe the further product documentation!