

Data sheet | Item number: 857-640

Multifunction timing relay with 1 changeover contact (1u); 8 time ranges; 14 functions; Temperature range: -25 °C ... +70 °C; for railway operations

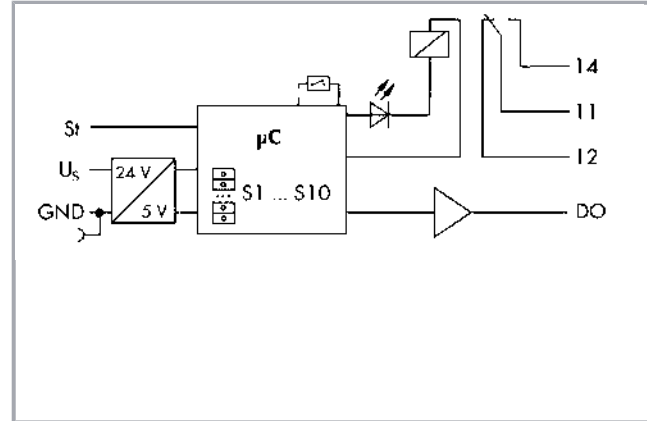

[www.wago.com/857-640](http://www.wago.com/857-640)

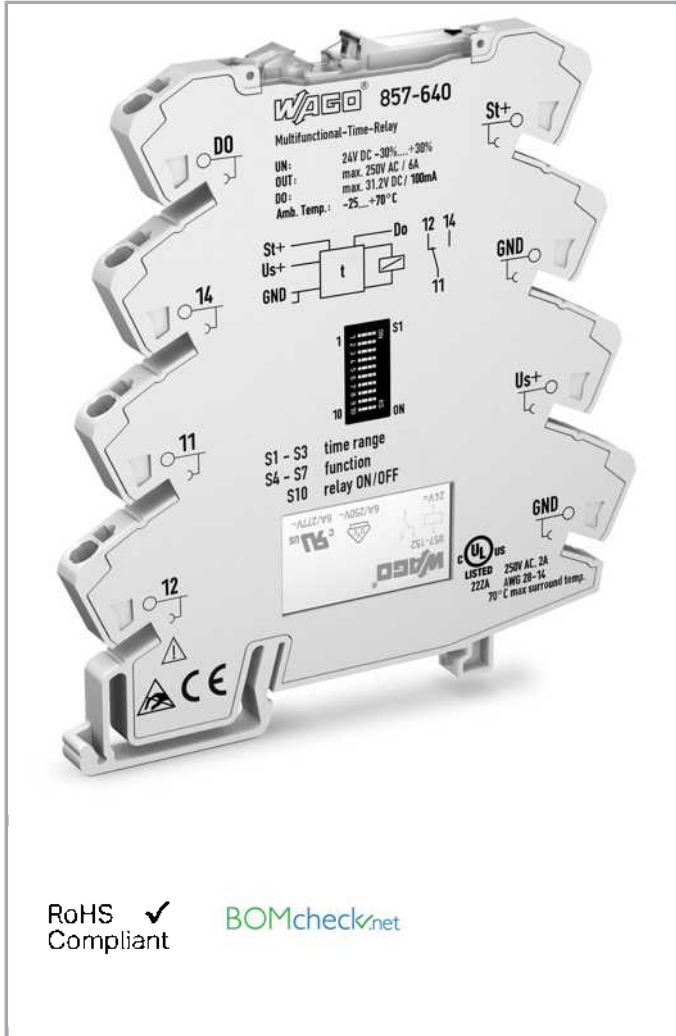

RoHS  Compliant

[BOMcheck.net](http://BOMcheck.net)

Subject to changes. Please also observe the further product documentation!

WAGO Kontakttechnik GmbH & Co. KG  
Hansastr. 27  
32423 Minden  
Phone: +49571 887-0 | Fax: +49571 887-169  
Email: [info.de@wago.com](mailto:info.de@wago.com) | Web: [www.wago.com](http://www.wago.com)

Do you have any questions about our products?  
We are always happy to take your call at +49 (571) 887-44222.

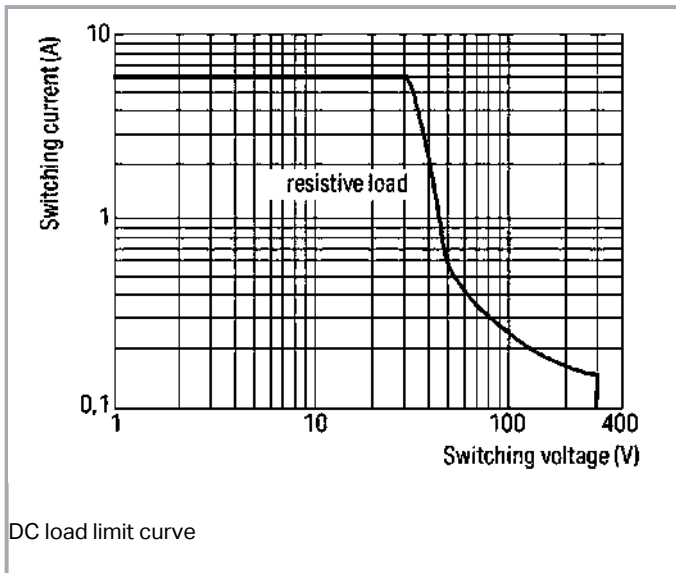
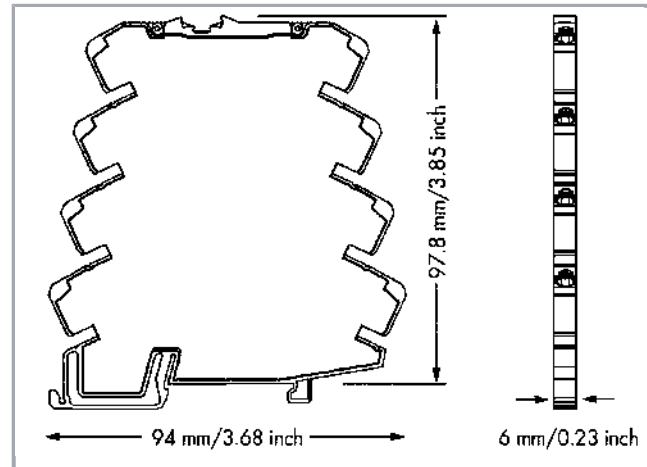
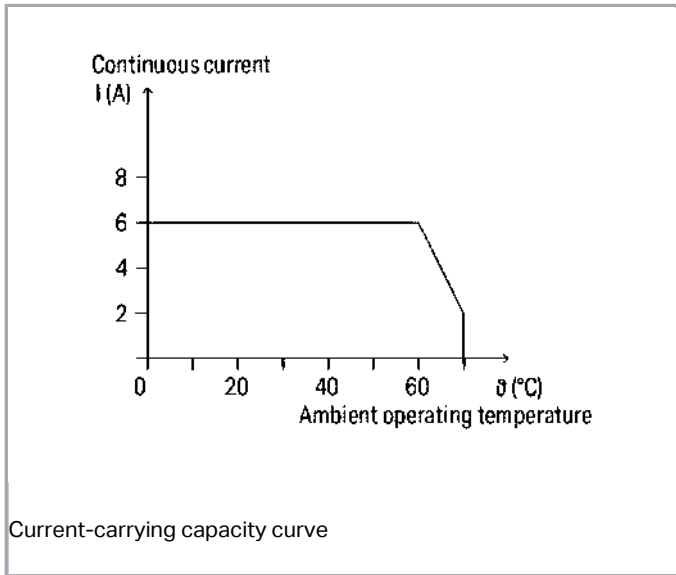

## Item description

### Features:

- 14 functions
- Function and time range adjustable via DIP switch

## Data

### Technical Data

Subject to changes. Please also observe the further product documentation!

## Control circuit

|                                |  |
|--------------------------------|--|
| Nominal input voltage $U_N$    | DC 24 V  |
| Input voltage range            | $\pm 30\%$   |
| Nominal input current at $U_N$ | 18 mA  |
| Time range                     | Adjustable: 0,01 ... 0,1 s; 0,1 ... 1 s; 1 ... 10 s; 10 ... 100 s; 1 ... 10 min; 10 ... 100 min; 1 ... 10 h; 10 ... 100 h  |
| Reset time                     | 50 ms  |
| Control input pulse length     | 10 ms  |
| Functions                      | On-delay<br>On-delay (with control input)<br>Off-delay (with control input)<br>On- and off-delay (with control input)<br>Single-shot leading edge<br>Single-shot leading edge (with control input)<br>Single-shot trailing edge (with control input)<br>Single-shot leading and trailing edge (with control input)<br>On-delay and single-shot leading edge<br>On-delay and single-shot leading edge (with control input)<br>Step switching<br>Flashing (pulse start)<br>Flashing, interval start<br>Relay switching |

## Load circuit:

|   |   |
|---|---|
| Number of changeover/switchover contacts      | 1   |
| Contact material (relay)                      | AgSnO <sub>2</sub>                          |
| Limiting continuous current                   | 6 A   |
| Max. make current (resistive)                 | (AC) 20 A / 0,02 s                          |
| Max. switching voltage                        | AC 250 V                                    |
| Max. switching power (resistive)              | AC 1500 VA; DC (see load limit curve)       |
| Switching capacity                            | AC-15: 3 A / AC 250 V; DC-13: 2 A / DC 24 V |
| Recommended minimum load                      | 10 V / 10 mA; 24 V / 1 mA                   |
| Pull-in time (typ.)                           | 15 ms                                       |
| Drop-out time (typ.)                          | 25 ms                                       |
| Bounce time (typ.)                            | 3.5 ms                                      |
| Electrical life (N.O.; resistive load; 23 °C) | 50 x 10 <sup>3</sup> switching operations   |
| Mechanical life                               | 5 x 10 <sup>6</sup> switching operations    |

Subject to changes. Please also observe the further product documentation!



Digital output (DO)

 $U_N - 1\text{ V}; 100\text{ mA}$ 

## Signaling

Status indication

Yellow LED

## Safety and protection:

Rated voltage

250 V

Rated impulse voltage

4 kV

Pollution degree

2

Dielectric strength, control/load circuit (AC, 1 min)

4 kVrms

Dielectric strength open contact (AC, 1 min)

1 kVrms

Protection class

IP20

## Connection data

Connection technology

Push-in CAGE CLAMP®

Solid conductor

0,34 ... 2,5 mm<sup>2</sup> / 22 ... 14 AWG

Fine-stranded conductor

0,34 ... 2,5 mm<sup>2</sup> / 22 ... 14 AWG

Strip length

9 ... 10 mm / 0.35 ... 0.39 inch

## Geometrical Data

Width

6 mm / 0.236 inch

Height from upper-edge of DIN-35 rail

97,8 mm / 3.85 inch

Depth

94 mm / 3.701 inch

## Mechanical data

Type of mounting

DIN-35 rail

## Material Data

Fire load

0.396 MJ

Weight

33.2 g

## Environmental Requirements

Surrounding air (operating) temperature at  $U_N$ 

-25 ... 70 °C

Surrounding air (storage) temperature

-40 ... 70 °C

Subject to changes. Please also observe the further product documentation!

WAGO Kontakttechnik GmbH &amp; Co. KG

Hansastr. 27

32423 Minden

Phone: +49571 887-0 | Fax: +49571 887-169

Email: [info.de@wago.com](mailto:info.de@wago.com) | Web: [www.wago.com](http://www.wago.com)

Do you have any questions about our products?

We are always happy to take your call at +49 (571) 887-44222.

Processing temperature

-25 ... +50 °C

## Standards and specifications

Standards/specifications

EN 61812-1; EN 61373; EN 50121-3-2; UL 508

## Commercial data

|                    |                           |
|--------------------|---------------------------|
| Product Group      | 6 (Interface Electronics) |
| Packaging type     | bag                       |
| Country of origin  | DE                        |
| GTIN               | 4050821565703             |
| Customs Tariff No. | 85364900990               |

## Approvals / Certificates



### UL-Approvals

| Logo  | Approval   | Additional Approval Text | Certificate name |
|---|--|--------------------------|------------------|
|  | UL<br>UL International Netherlands B.V. (ORDINARY LOCATIONS) | UL 508                   | E175199<br>Sec.4 |















## Counterpart

## Compatible products















### General accessories

|  |  |  |
|--|--|--|
|  | <b>Item no.: 209-184</b><br>Protection cover; transparent  | <a href="http://www.wago.com/209-184">www.wago.com/209-184</a> |
| <b>tools</b>   |  |  |
|  | <b>Item no.: 210-720</b><br>Operating tool; Blade: 3.5 x 0.5 mm; with a partially insulated shaft  | <a href="http://www.wago.com/210-720">www.wago.com/210-720</a> |
| <b>ferrule</b>   |  |  |
|  | <b>Item no.: 216-241</b><br>Ferrule; Sleeve for 0.5 mm <sup>2</sup> / 20 AWG; insulated; electro-tin plated; electrolytic copper; gastight | <a href="http://www.wago.com/216-241">www.wago.com/216-241</a> |













Subject to changes. Please also observe the further product documentation!

|   |  |  |
|---|--|--|
|    | crimped; acc. to DIN 46228, Part 4/09.90; white  |  |
|    | <b>Item no.: 216-242</b><br>Ferrule; Sleeve for 0.75 mm <sup>2</sup> / 18 AWG; insulated; electro-tin plated; electrolytic copper; gastight crimped; acc. to DIN 46228, Part 4/09.90; gray | <a href="http://www.wago.com/216-242">www.wago.com/216-242</a>                 |
|    | <b>Item no.: 216-243</b><br>Ferrule; Sleeve for 1 mm <sup>2</sup> / AWG 18; insulated; electro-tin plated; electrolytic copper; gastight crimped; acc. to DIN 46228, Part 4/09.90; red     | <a href="http://www.wago.com/216-243">www.wago.com/216-243</a>                 |
|    | <b>Item no.: 216-244</b><br>Ferrule; Sleeve for 1.5 mm <sup>2</sup> / AWG 16; insulated; electro-tin plated; electrolytic copper; gastight crimped; acc. to DIN 46228, Part 4/09.90; black | <a href="http://www.wago.com/216-244">www.wago.com/216-244</a>                 |
| <b>Jumper</b>   |  |  |
|    | <b>Item no.: 281-482</b><br>Comb-style jumper bar; insulated; 2-way; IN = IN terminal block; gray  | <a href="http://www.wago.com/281-482">www.wago.com/281-482</a>                 |
|    | <b>Item no.: 859-402</b><br>Push-in type jumper bar; 2-way; Nominal current 18 A; insulated; light gray  | <a href="http://www.wago.com/859-402">www.wago.com/859-402</a>                 |
|    | <b>Item no.: 859-402/000-005</b><br>Push-in type jumper bar; 2-way; Nominal current 18 A; insulated; red   | <a href="http://www.wago.com/859-402/000-005">www.wago.com/859-402/000-005</a> |
|   | <b>Item no.: 859-402/000-006</b><br>Push-in type jumper bar; 2-way; Nominal current 18 A; insulated; blue  | <a href="http://www.wago.com/859-402/000-006">www.wago.com/859-402/000-006</a> |
|  | <b>Item no.: 859-402/000-029</b><br>Push-in type jumper bar; 2-way; Nominal current 18 A; insulated; yellow  | <a href="http://www.wago.com/859-402/000-029">www.wago.com/859-402/000-029</a> |
|  | <b>Item no.: 859-403</b><br>Push-in type jumper bar; 3-way; Nominal current 18 A; insulated; light gray  | <a href="http://www.wago.com/859-403">www.wago.com/859-403</a>                 |
|  | <b>Item no.: 859-403/000-005</b><br>Push-in type jumper bar; 3-way; Nominal current 18 A; insulated; red   | <a href="http://www.wago.com/859-403/000-005">www.wago.com/859-403/000-005</a> |
|  | <b>Item no.: 859-403/000-006</b><br>Push-in type jumper bar; 3-way; Nominal current 18 A; insulated; blue  | <a href="http://www.wago.com/859-403/000-006">www.wago.com/859-403/000-006</a> |
|  | <b>Item no.: 859-403/000-029</b><br>Push-in type jumper bar; 3-way; Nominal current 18 A; insulated; yellow  | <a href="http://www.wago.com/859-403/000-029">www.wago.com/859-403/000-029</a> |
|  | <b>Item no.: 859-404</b><br>Push-in type jumper bar; 4-way; Nominal current 18 A; insulated; light gray  | <a href="http://www.wago.com/859-404">www.wago.com/859-404</a>                 |
|  | <b>Item no.: 859-404/000-005</b><br>Push-in type jumper bar; 4-way; Nominal current 18 A; insulated; red   | <a href="http://www.wago.com/859-404/000-005">www.wago.com/859-404/000-005</a> |



Subject to changes. Please also observe the further product documentation!

|  |   |  |
|--|---|--|
|    | <b>Item no.: 859-404/000-006</b><br>Push-in type jumper bar; 4-way; Nominal current 18 A; insulated; blue   | <a href="http://www.wago.com/859-404/000-006">www.wago.com/859-404/000-006</a> |
|    | <b>Item no.: 859-404/000-029</b><br>Push-in type jumper bar; 4-way; Nominal current 18 A; insulated; yellow | <a href="http://www.wago.com/859-404/000-029">www.wago.com/859-404/000-029</a> |
|    | <b>Item no.: 859-405</b><br>Push-in type jumper bar; 5-way; Nominal current 18 A; insulated; light gray     | <a href="http://www.wago.com/859-405">www.wago.com/859-405</a>                 |
|    | <b>Item no.: 859-405/000-005</b><br>Push-in type jumper bar; 5-way; Nominal current 18 A; insulated; red    | <a href="http://www.wago.com/859-405/000-005">www.wago.com/859-405/000-005</a> |
|    | <b>Item no.: 859-405/000-006</b><br>Push-in type jumper bar; 5-way; Nominal current 18 A; insulated; blue   | <a href="http://www.wago.com/859-405/000-006">www.wago.com/859-405/000-006</a> |
|    | <b>Item no.: 859-405/000-029</b><br>Push-in type jumper bar; 5-way; Nominal current 18 A; insulated; yellow | <a href="http://www.wago.com/859-405/000-029">www.wago.com/859-405/000-029</a> |
|    | <b>Item no.: 859-406</b><br>Push-in type jumper bar; 6-way; Nominal current 18 A; insulated; light gray     | <a href="http://www.wago.com/859-406">www.wago.com/859-406</a>                 |
|  | <b>Item no.: 859-406/000-005</b><br>Push-in type jumper bar; 6-way; Nominal current 18 A; insulated; red    | <a href="http://www.wago.com/859-406/000-005">www.wago.com/859-406/000-005</a> |
|  | <b>Item no.: 859-406/000-006</b><br>Push-in type jumper bar; 6-way; Nominal current 18 A; insulated; blue   | <a href="http://www.wago.com/859-406/000-006">www.wago.com/859-406/000-006</a> |
|  | <b>Item no.: 859-406/000-029</b><br>Push-in type jumper bar; 6-way; Nominal current 18 A; insulated; yellow | <a href="http://www.wago.com/859-406/000-029">www.wago.com/859-406/000-029</a> |
|  | <b>Item no.: 859-407</b><br>Push-in type jumper bar; 7-way; Nominal current 18 A; insulated; light gray     | <a href="http://www.wago.com/859-407">www.wago.com/859-407</a>                 |
|  | <b>Item no.: 859-407/000-005</b><br>Push-in type jumper bar; 7-way; Nominal current 18 A; insulated; red    | <a href="http://www.wago.com/859-407/000-005">www.wago.com/859-407/000-005</a> |
|  | <b>Item no.: 859-407/000-006</b><br>Push-in type jumper bar; 7-way; Nominal current 18 A; insulated; blue   | <a href="http://www.wago.com/859-407/000-006">www.wago.com/859-407/000-006</a> |
|  | <b>Item no.: 859-407/000-029</b><br>Push-in type jumper bar; 7-way; Nominal current 18 A; insulated; yellow | <a href="http://www.wago.com/859-407/000-029">www.wago.com/859-407/000-029</a> |

Subject to changes. Please also observe the further product documentation!















|  |  |  |
|--|--|--|
|    | <b>Item no.: 859-408</b><br>Push-in type jumper bar; 8-way; Nominal current 18 A; insulated; light gray      | <a href="http://www.wago.com/859-408">www.wago.com/859-408</a>                 |
|    | <b>Item no.: 859-408/000-005</b><br>Push-in type jumper bar; 8-way; Nominal current 18 A; insulated; red     | <a href="http://www.wago.com/859-408/000-005">www.wago.com/859-408/000-005</a> |
|    | <b>Item no.: 859-408/000-006</b><br>Push-in type jumper bar; 8-way; Nominal current 18 A; insulated; blue    | <a href="http://www.wago.com/859-408/000-006">www.wago.com/859-408/000-006</a> |
|    | <b>Item no.: 859-408/000-029</b><br>Push-in type jumper bar; 8-way; Nominal current 18 A; insulated; yellow  | <a href="http://www.wago.com/859-408/000-029">www.wago.com/859-408/000-029</a> |
|    | <b>Item no.: 859-409</b><br>Push-in type jumper bar; 9-way; Nominal current 18 A; insulated; light gray      | <a href="http://www.wago.com/859-409">www.wago.com/859-409</a>                 |
|    | <b>Item no.: 859-409/000-005</b><br>Push-in type jumper bar; 9-way; Nominal current 18 A; insulated; red     | <a href="http://www.wago.com/859-409/000-005">www.wago.com/859-409/000-005</a> |
|    | <b>Item no.: 859-409/000-006</b><br>Push-in type jumper bar; 9-way; Nominal current 18 A; insulated; blue    | <a href="http://www.wago.com/859-409/000-006">www.wago.com/859-409/000-006</a> |
|   | <b>Item no.: 859-409/000-029</b><br>Push-in type jumper bar; 9-way; Nominal current 18 A; insulated; yellow  | <a href="http://www.wago.com/859-409/000-029">www.wago.com/859-409/000-029</a> |
|  | <b>Item no.: 859-410</b><br>Push-in type jumper bar; 10-way; Nominal current 18 A; insulated; light gray     | <a href="http://www.wago.com/859-410">www.wago.com/859-410</a>                 |
|  | <b>Item no.: 859-410/000-005</b><br>Push-in type jumper bar; 10-way; Nominal current 18 A; insulated; red    | <a href="http://www.wago.com/859-410/000-005">www.wago.com/859-410/000-005</a> |
|  | <b>Item no.: 859-410/000-006</b><br>Push-in type jumper bar; 10-way; Nominal current 18 A; insulated; blue   | <a href="http://www.wago.com/859-410/000-006">www.wago.com/859-410/000-006</a> |
|  | <b>Item no.: 859-410/000-029</b><br>Push-in type jumper bar; 10-way; Nominal current 18 A; insulated; yellow | <a href="http://www.wago.com/859-410/000-029">www.wago.com/859-410/000-029</a> |

**Marking accessories**













|  |   |  |
|--|---|--|
|  | <b>Item no.: 2009-110</b><br>Marking strips; on reel; not stretchable; plain; snap-on type; white                                   | <a href="http://www.wago.com/2009-110">www.wago.com/2009-110</a> |
|  | <b>Item no.: 2009-115</b><br>WMB-Inline; for Smart Printer; 1500 pieces on roll; stretchable 5 - 5.2 mm; plain; snap-on type; white | <a href="http://www.wago.com/2009-115">www.wago.com/2009-115</a> |

Subject to changes. Please also observe the further product documentation!



|  |  |  |
|--|--|--|
|    | <b>Item no.: 2009-115/000-002</b><br>WMB-Inline; for Smart Printer; 1500 pieces on roll; stretchable 5 - 5.2 mm; plain; snap-on type; yellow | <a href="http://www.wago.com/2009-115/000-002">www.wago.com/2009-115/000-002</a> |
|    | <b>Item no.: 2009-115/000-006</b><br>WMB-Inline; for Smart Printer; 1500 pieces on roll; stretchable 5 - 5.2 mm; plain; snap-on type; white  | <a href="http://www.wago.com/2009-115/000-006">www.wago.com/2009-115/000-006</a> |
|    | <b>Item no.: 2009-115/000-007</b><br>WMB-Inline; for Smart Printer; 1500 pieces on roll; stretchable 5 - 5.2 mm; plain; snap-on type; gray   | <a href="http://www.wago.com/2009-115/000-007">www.wago.com/2009-115/000-007</a> |
|    | <b>Item no.: 2009-115/000-012</b><br>WMB-Inline; for Smart Printer; 1500 pieces on roll; stretchable 5 - 5.2 mm; plain; snap-on type; white  | <a href="http://www.wago.com/2009-115/000-012">www.wago.com/2009-115/000-012</a> |
|    | <b>Item no.: 2009-115/000-017</b><br>WMB-Inline; for Smart Printer; 1500 pieces on roll; stretchable 5 - 5.2 mm; plain; snap-on type; white  | <a href="http://www.wago.com/2009-115/000-017">www.wago.com/2009-115/000-017</a> |
|    | <b>Item no.: 2009-115/000-023</b><br>WMB-Inline; for Smart Printer; 1500 pieces on roll; stretchable 5 - 5.2 mm; plain; snap-on type; green  | <a href="http://www.wago.com/2009-115/000-023">www.wago.com/2009-115/000-023</a> |
|    | <b>Item no.: 2009-115/000-024</b><br>WMB-Inline; for Smart Printer; 1500 pieces on roll; stretchable 5 - 5.2 mm; plain; snap-on type; white  | <a href="http://www.wago.com/2009-115/000-024">www.wago.com/2009-115/000-024</a> |
|  | <b>Item no.: 209-128</b><br>Adaptor; gray  | <a href="http://www.wago.com/209-128">www.wago.com/209-128</a>                   |
|  | <b>Item no.: 209-183</b><br>Marker card; white   | <a href="http://www.wago.com/209-183">www.wago.com/209-183</a>                   |
|  | <b>Item no.: 210-110</b><br>Fiber-tip pen  | <a href="http://www.wago.com/210-110">www.wago.com/210-110</a>                   |
|  | <b>Item no.: 249-105</b><br>Group marker carrier; gray   | <a href="http://www.wago.com/249-105">www.wago.com/249-105</a>                   |
|  | <b>Item no.: 793-501</b><br>WMB marking card; as card; not stretchable; plain; snap-on type; white   | <a href="http://www.wago.com/793-501">www.wago.com/793-501</a>                   |
|  | <b>Item no.: 793-501/000-002</b><br>WMB marking card; as card; not stretchable; plain; snap-on type; yellow                                  | <a href="http://www.wago.com/793-501/000-002">www.wago.com/793-501/000-002</a>   |
|  | <b>Item no.: 793-501/000-005</b><br>WMB marking card; as card; not stretchable; plain; snap-on type; red                                     | <a href="http://www.wago.com/793-501/000-005">www.wago.com/793-501/000-005</a>   |
|  | <b>Item no.: 793-501/000-006</b><br>WMB marking card; as card; not stretchable; plain; snap-on type; blue                                    | <a href="http://www.wago.com/793-501/000-006">www.wago.com/793-501/000-006</a>   |

Subject to changes. Please also observe the further product documentation!

|  |   |  |
|--|---|--|
|    | <b>Item no.: 793-501/000-007</b><br>WMB marking card; as card; not stretchable; plain; snap-on type; gray   | <a href="http://www.wago.com/793-501/000-007">www.wago.com/793-501/000-007</a> |
|    | <b>Item no.: 793-501/000-012</b><br>WMB marking card; as card; not stretchable; plain; snap-on type; orange   | <a href="http://www.wago.com/793-501/000-012">www.wago.com/793-501/000-012</a> |
|    | <b>Item no.: 793-501/000-017</b><br>WMB marking card; as card; not stretchable; plain; snap-on type; light green                                      | <a href="http://www.wago.com/793-501/000-017">www.wago.com/793-501/000-017</a> |
|    | <b>Item no.: 793-501/000-023</b><br>WMB marking card; as card; not stretchable; plain; snap-on type; green  | <a href="http://www.wago.com/793-501/000-023">www.wago.com/793-501/000-023</a> |
|    | <b>Item no.: 793-501/000-024</b><br>WMB marking card; as card; not stretchable; plain; snap-on type; violet   | <a href="http://www.wago.com/793-501/000-024">www.wago.com/793-501/000-024</a> |
|    | <b>Item no.: 793-502</b><br>WMB marking card; as card; MARKED; 1 ... 10 (10x); not stretchable; Horizontal marking; snap-on type; white               | <a href="http://www.wago.com/793-502">www.wago.com/793-502</a>                 |
|   | <b>Item no.: 793-502/000-002</b><br>WMB marking card; as card; MARKED; 1 ... 10 (10x); not stretchable; Horizontal marking; snap-on type; yellow      | <a href="http://www.wago.com/793-502/000-002">www.wago.com/793-502/000-002</a> |
|  | <b>Item no.: 793-502/000-005</b><br>WMB marking card; as card; MARKED; 1 ... 10 (10x); not stretchable; Horizontal marking; snap-on type; red         | <a href="http://www.wago.com/793-502/000-005">www.wago.com/793-502/000-005</a> |
|  | <b>Item no.: 793-502/000-006</b><br>WMB marking card; as card; MARKED; 1 ... 10 (10x); not stretchable; Horizontal marking; snap-on type; blue        | <a href="http://www.wago.com/793-502/000-006">www.wago.com/793-502/000-006</a> |
|  | <b>Item no.: 793-502/000-007</b><br>WMB marking card; as card; MARKED; 1 ... 10 (10x); not stretchable; Horizontal marking; snap-on type; gray        | <a href="http://www.wago.com/793-502/000-007">www.wago.com/793-502/000-007</a> |
|  | <b>Item no.: 793-502/000-012</b><br>WMB marking card; as card; MARKED; 1 ... 10 (10x); not stretchable; Horizontal marking; snap-on type; orange      | <a href="http://www.wago.com/793-502/000-012">www.wago.com/793-502/000-012</a> |
|  | <b>Item no.: 793-502/000-017</b><br>WMB marking card; as card; MARKED; 1 ... 10 (10x); not stretchable; Horizontal marking; snap-on type; light green | <a href="http://www.wago.com/793-502/000-017">www.wago.com/793-502/000-017</a> |
|  | <b>Item no.: 793-502/000-023</b><br>WMB marking card; as card; MARKED; 1 ... 10 (10x); not stretchable; Horizontal marking; snap-on type; green       | <a href="http://www.wago.com/793-502/000-023">www.wago.com/793-502/000-023</a> |
|  | <b>Item no.: 793-502/000-024</b>  |  |

Subject to changes. Please also observe the further product documentation!



WMB marking card; as card; MARKED; 1 ... 10 (10x); not stretchable; Horizontal marking; snap-on type; violet [www.wago.com/793-502/000-024](http://www.wago.com/793-502/000-024)



**Item no.: 793-503**  
WMB marking card; as card; MARKED; 11 ... 20 (10x); not stretchable; Horizontal marking; snap-on type; white [www.wago.com/793-503](http://www.wago.com/793-503)



**Item no.: 793-503/000-002**  
WMB marking card; as card; MARKED; 11 ... 20 (10x); not stretchable; Horizontal marking; snap-on type; yellow [www.wago.com/793-503/000-002](http://www.wago.com/793-503/000-002)



**Item no.: 793-503/000-005**  
WMB marking card; as card; MARKED; 11 ... 20 (10x); not stretchable; Horizontal marking; snap-on type; red [www.wago.com/793-503/000-005](http://www.wago.com/793-503/000-005)



**Item no.: 793-503/000-006**  
WMB marking card; as card; MARKED; 11 ... 20 (10x); not stretchable; Horizontal marking; snap-on type; blue [www.wago.com/793-503/000-006](http://www.wago.com/793-503/000-006)



**Item no.: 793-503/000-007**  
WMB marking card; as card; MARKED; 11 ... 20 (10x); not stretchable; Horizontal marking; snap-on type; gray [www.wago.com/793-503/000-007](http://www.wago.com/793-503/000-007)



**Item no.: 793-503/000-012**  
WMB marking card; as card; MARKED; 11 ... 20 (10x); not stretchable; Horizontal marking; snap-on type; orange [www.wago.com/793-503/000-012](http://www.wago.com/793-503/000-012)



**Item no.: 793-503/000-017**  
WMB marking card; as card; MARKED; 11 ... 20 (10x); not stretchable; Horizontal marking; snap-on type; light green [www.wago.com/793-503/000-017](http://www.wago.com/793-503/000-017)



**Item no.: 793-503/000-023**  
WMB marking card; as card; MARKED; 11 ... 20 (10x); not stretchable; Horizontal marking; snap-on type; green [www.wago.com/793-503/000-023](http://www.wago.com/793-503/000-023)



**Item no.: 793-503/000-024**  
WMB marking card; as card; MARKED; 11 ... 20 (10x); not stretchable; Horizontal marking; snap-on type; violet [www.wago.com/793-503/000-024](http://www.wago.com/793-503/000-024)



**Item no.: 793-504**  
WMB marking card; as card; MARKED; 21 ... 30 (10x); not stretchable; Horizontal marking; snap-on type; white [www.wago.com/793-504](http://www.wago.com/793-504)



**Item no.: 793-504/000-002**  
WMB marking card; as card; MARKED; 21 ... 30 (10x); not stretchable; Horizontal marking; snap-on type; yellow [www.wago.com/793-504/000-002](http://www.wago.com/793-504/000-002)















**Item no.: 793-504/000-005**  
WMB marking card; as card; MARKED; 21 ... 30 (10x); not stretchable; Horizontal marking; snap-on type; red [www.wago.com/793-504/000-005](http://www.wago.com/793-504/000-005)



**Item no.: 793-504/000-006**  
WMB marking card; as card; MARKED; 21 ... 30 (10x); not stretchable; Horizontal marking; snap-on type; blue [www.wago.com/793-504/000-006](http://www.wago.com/793-504/000-006)

Subject to changes. Please also observe the further product documentation!

|  |   |  |
|--|---|--|
|    | <b>Item no.: 793-504/000-012</b><br>WMB marking card; as card; MARKED; 21 ... 30 (10x); not stretchable; Horizontal marking; snap-on type;<br>orange      | <a href="http://www.wago.com/793-504/000-012">www.wago.com/793-504/000-012</a> |
|    | <b>Item no.: 793-504/000-017</b><br>WMB marking card; as card; MARKED; 21 ... 30 (10x); not stretchable; Horizontal marking; snap-on type;<br>light green | <a href="http://www.wago.com/793-504/000-017">www.wago.com/793-504/000-017</a> |
|    | <b>Item no.: 793-504/000-023</b><br>WMB marking card; as card; MARKED; 21 ... 30 (10x); not stretchable; Horizontal marking; snap-on type;<br>green       | <a href="http://www.wago.com/793-504/000-023">www.wago.com/793-504/000-023</a> |
|    | <b>Item no.: 793-505</b><br>WMB marking card; as card; MARKED; 31 ... 40 (10x); not stretchable; Horizontal marking; snap-on type;<br>white               | <a href="http://www.wago.com/793-505">www.wago.com/793-505</a>                 |
|    | <b>Item no.: 793-505/000-005</b><br>WMB marking card; as card; MARKED; 31 ... 40 (10x); not stretchable; Horizontal marking; snap-on type;<br>red         | <a href="http://www.wago.com/793-505/000-005">www.wago.com/793-505/000-005</a> |
|    | <b>Item no.: 793-505/000-006</b><br>WMB marking card; as card; MARKED; 31 ... 40 (10x); not stretchable; Horizontal marking; snap-on type;<br>blue        | <a href="http://www.wago.com/793-505/000-006">www.wago.com/793-505/000-006</a> |
|   | <b>Item no.: 793-505/000-007</b><br>WMB marking card; as card; MARKED; 31 ... 40 (10x); not stretchable; Horizontal marking; snap-on type;<br>gray        | <a href="http://www.wago.com/793-505/000-007">www.wago.com/793-505/000-007</a> |
|  | <b>Item no.: 793-505/000-012</b><br>WMB marking card; as card; MARKED; 31 ... 40 (10x); not stretchable; Horizontal marking; snap-on type;<br>orange      | <a href="http://www.wago.com/793-505/000-012">www.wago.com/793-505/000-012</a> |
|  | <b>Item no.: 793-506</b><br>WMB marking card; as card; MARKED; 41 ... 50 (10x); not stretchable; Horizontal marking; snap-on type;<br>white               | <a href="http://www.wago.com/793-506">www.wago.com/793-506</a>                 |
|  | <b>Item no.: 793-506/000-005</b><br>WMB marking card; as card; MARKED; 41 ... 50 (10x); not stretchable; Horizontal marking; snap-on type;<br>red         | <a href="http://www.wago.com/793-506/000-005">www.wago.com/793-506/000-005</a> |
|  | <b>Item no.: 793-506/000-006</b><br>WMB marking card; as card; MARKED; 41 ... 50 (10x); not stretchable; Horizontal marking; snap-on type;<br>blue        | <a href="http://www.wago.com/793-506/000-006">www.wago.com/793-506/000-006</a> |
|  | <b>Item no.: 793-506/000-012</b><br>WMB marking card; as card; MARKED; 41 ... 50 (10x); not stretchable; Horizontal marking; snap-on type;<br>orange      | <a href="http://www.wago.com/793-506/000-012">www.wago.com/793-506/000-012</a> |
|  | <b>Item no.: 793-506/000-017</b><br>WMB marking card; as card; MARKED; 41 ... 50 (10x); not stretchable; Horizontal marking; snap-on type;<br>light green | <a href="http://www.wago.com/793-506/000-017">www.wago.com/793-506/000-017</a> |
|  | <b>Item no.: 793-5501</b><br>WMB marking card; as card; for terminal block width 5 - 17.5 mm; stretchable 5 - 5.2 mm; plain; snap-on                      | <a href="http://www.wago.com/793-5501">www.wago.com/793-5501</a>               |

Subject to changes. Please also observe the further product documentation!



type; white

**Item no.: 793-5501/000-002**

WMB marking card; as card; for terminal block width 5 - 17.5 mm; stretchable 5 - 5.2 mm; plain; snap-on type; yellow

[www.wago.com/793-5501/000-002](http://www.wago.com/793-5501/000-002)**Item no.: 793-5501/000-005**

WMB marking card; as card; for terminal block width 5 - 17.5 mm; stretchable 5 - 5.2 mm; plain; snap-on type; red

[www.wago.com/793-5501/000-005](http://www.wago.com/793-5501/000-005)**Item no.: 793-5501/000-006**

WMB marking card; as card; for terminal block width 5 - 17.5 mm; stretchable 5 - 5.2 mm; plain; snap-on type; blue

[www.wago.com/793-5501/000-006](http://www.wago.com/793-5501/000-006)**Item no.: 793-5501/000-007**

WMB marking card; as card; for terminal block width 5 - 17.5 mm; stretchable 5 - 5.2 mm; plain; snap-on type; gray

[www.wago.com/793-5501/000-007](http://www.wago.com/793-5501/000-007)**Item no.: 793-5501/000-012**

WMB marking card; as card; for terminal block width 5 - 17.5 mm; stretchable 5 - 5.2 mm; plain; snap-on type; orange

[www.wago.com/793-5501/000-012](http://www.wago.com/793-5501/000-012)**Item no.: 793-5501/000-014**

WMB marking card; as card; for terminal block width 5 - 17.5 mm; stretchable 5 - 5.2 mm; plain; snap-on type; brown

[www.wago.com/793-5501/000-014](http://www.wago.com/793-5501/000-014)**Item no.: 793-5501/000-017**

WMB marking card; as card; for terminal block width 5 - 17.5 mm; stretchable 5 - 5.2 mm; plain; snap-on type; green

[www.wago.com/793-5501/000-017](http://www.wago.com/793-5501/000-017)**Item no.: 793-5501/000-023**

WMB marking card; as card; for terminal block width 5 - 17.5 mm; stretchable 5 - 5.2 mm; plain; snap-on type; light green

[www.wago.com/793-5501/000-023](http://www.wago.com/793-5501/000-023)**Item no.: 793-5501/000-024**

WMB marking card; as card; for terminal block width 5 - 17.5 mm; stretchable 5 - 5.2 mm; plain; snap-on type; violet

[www.wago.com/793-5501/000-024](http://www.wago.com/793-5501/000-024)**Item no.: 793-566**

WMB marking card; as card; MARKED; 1 ... 50 (2x); not stretchable; Horizontal marking; snap-on type; white

[www.wago.com/793-566](http://www.wago.com/793-566)**Item no.: 793-566/000-002**

WMB marking card; as card; MARKED; 1 ... 50 (2x); not stretchable; Horizontal marking; snap-on type; yellow

[www.wago.com/793-566/000-002](http://www.wago.com/793-566/000-002)**Item no.: 793-566/000-005**

WMB marking card; as card; MARKED; 1 ... 50 (2x); not stretchable; Horizontal marking; snap-on type; red

[www.wago.com/793-566/000-005](http://www.wago.com/793-566/000-005)**Item no.: 793-566/000-006**

WMB marking card; as card; MARKED; 1 ... 50 (2x); not stretchable; Horizontal marking; snap-on type; blue

[www.wago.com/793-566/000-006](http://www.wago.com/793-566/000-006)

Subject to changes. Please also observe the further product documentation!

WAGO Kontakttechnik GmbH &amp; Co. KG

Hansastr. 27





32423 Minden

Phone: +49571 887-0 | Fax: +49571 887-169

Email: [info.de@wago.com](mailto:info.de@wago.com) | Web: [www.wago.com](http://www.wago.com)

Do you have any questions about our products?

We are always happy to take your call at +49 (571) 887-44222.

|  |  |  |
|--|--|--|
|  | <b>Item no.: 793-566/000-007</b><br>WMB marking card; as card; MARKED; 1 ... 50 (2x); not stretchable; Horizontal marking; snap-on type; gray        | <a href="http://www.wago.com/793-566/000-007">www.wago.com/793-566/000-007</a> |
|  | <b>Item no.: 793-566/000-012</b><br>WMB marking card; as card; MARKED; 1 ... 50 (2x); not stretchable; Horizontal marking; snap-on type; orange      | <a href="http://www.wago.com/793-566/000-012">www.wago.com/793-566/000-012</a> |
|  | <b>Item no.: 793-566/000-017</b><br>WMB marking card; as card; MARKED; 1 ... 50 (2x); not stretchable; Horizontal marking; snap-on type; light green | <a href="http://www.wago.com/793-566/000-017">www.wago.com/793-566/000-017</a> |
|  | <b>Item no.: 793-566/000-023</b><br>WMB marking card; as card; MARKED; 1 ... 50 (2x); not stretchable; Horizontal marking; snap-on type; green       | <a href="http://www.wago.com/793-566/000-023">www.wago.com/793-566/000-023</a> |
|  | <b>Item no.: 793-566/000-024</b><br>WMB marking card; as card; MARKED; 1 ... 50 (2x); not stretchable; Horizontal marking; snap-on type; violet      | <a href="http://www.wago.com/793-566/000-024">www.wago.com/793-566/000-024</a> |

## Downloads

### Documentation

#### Bid Text

|                              |              |                 |          |
|------------------------------|--------------|-----------------|----------|
| 857-640<br>GAEB docx - Datei | Feb 20, 2019 | docx<br>17.8 kB | Download |
| 857-640<br>GAEB X81 - Datei  | Feb 19, 2019 | xml<br>6.3 kB   | Download |

#### Instruction Leaflet

|   |  |               |          |
|---|--|---------------|----------|
| Relaisbaustein mit gestecktem Kleinschaltrelais<br>Multifunktionszeitrelais, 1 Wechsler (1u) , DC 24 V, 8 Zeitbereiche, 14 Funktionen |  | pdf<br>2.0 MB | Download |
|---|--|---------------|----------|

#### Additional Information

|  |         |                 |          |
|--|---------|-----------------|----------|
| Disposal; Electrical and electronic equipment, Packaging | V 1.0.0 | pdf<br>265.8 kB | Download |
|--|---------|-----------------|----------|

## CAD/CAE-Data

### CAD data

|                      |  |     |          |
|----------------------|--|-----|----------|
| 2D/3D Models 857-640 |  | URL | Download |
|----------------------|--|-----|----------|

Subject to changes. Please also observe the further product documentation!

## CAE data

EPLAN Data Portal 857-640

URL

Download

WSCAD Universe 857-640

URL

Download

## Installation Notes

### Inserting a conductor

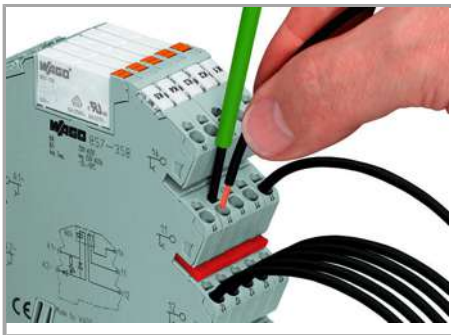

Connection of conductor

### Jumpered

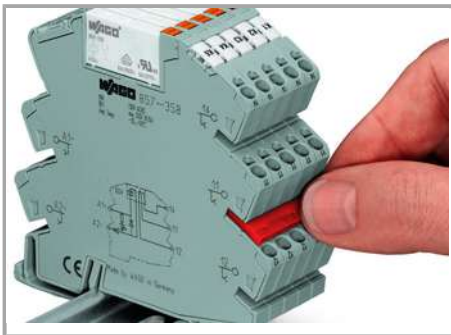

Easy commoning using adjacent jumpers

### Marking

Subject to changes. Please also observe the further product documentation!



Marking using WMB Multi markers

### Installation



Operation of the relay ejector

Subject to changes. Please also observe the further product documentation!