

Data sheet | Item number: 858-314

Relay module; Nominal input voltage: 24 VDC; 4 changeover contacts;
 Limiting continuous current: 5 A; with gold contacts; with manual operation;
 Red status indicator; Module width: 31 mm; 1,50 mm²



www.wago.com/858-314



RoHS Compliant [BOMcheck.net](https://www.bomcheck.net)

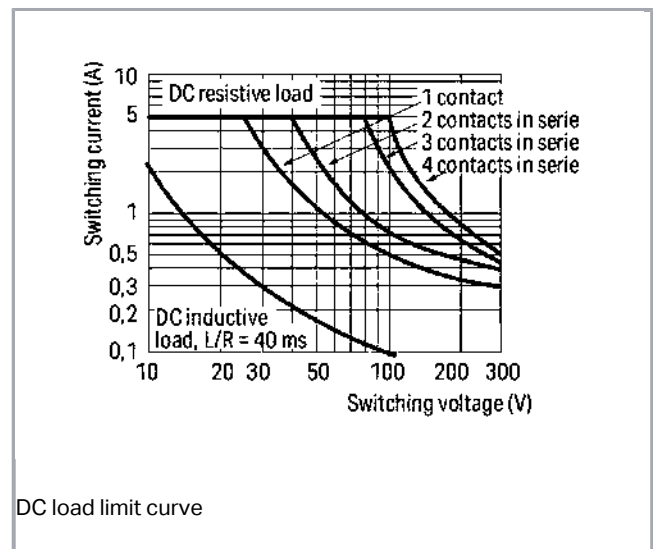
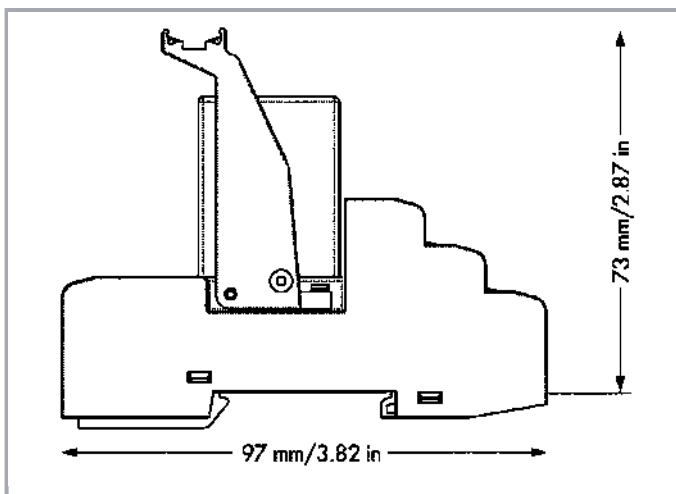
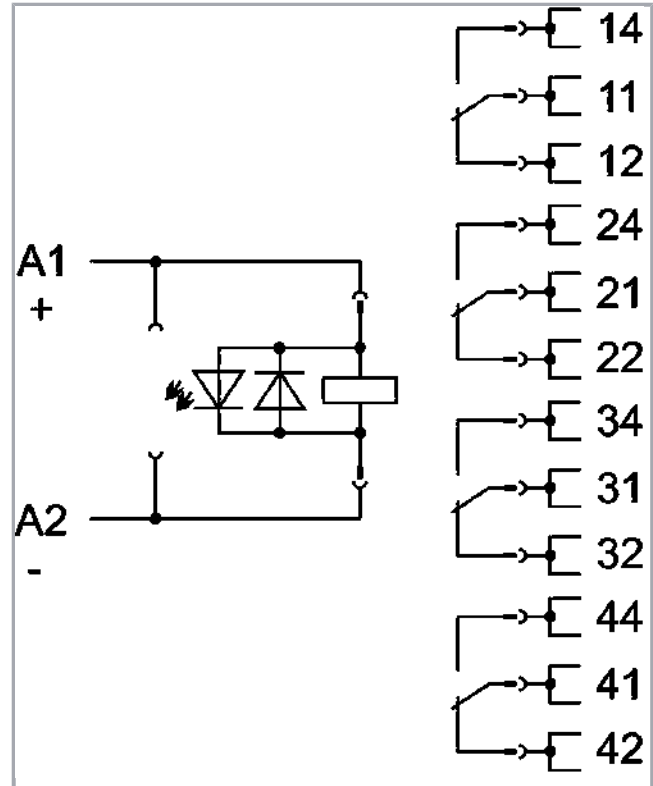

Subject to changes. Please also observe the further product documentation!

WAGO Kontakttechnik GmbH & Co. KG
 Hansastr. 27
 32423 Minden
 Phone: +49571 887-0 | Fax: +49571 887-169
 Email: info.de@wago.com | Web: www.wago.com

Do you have any questions about our products?
 We are always happy to take your call at +49 (571) 887-44222.



Item description

Note:

To prevent damaging the gold layer, 30 VDC switching voltages and 50 mA currents must not be exceeded. Higher switching power eventually evaporates the gold layer. The resulting deposits in the housing may reduce service life.

Data

Technical Data

Control circuit

| | |
|--------------------------------|---------------|
| Nominal input voltage U_N | DC 24 V |
| Input voltage range | -20 ... +10 % |
| Nominal input current at U_N | 36,9 mA |

Load circuit:

| | |
|---|--|
| Number of changeover/switchover contacts | 4 |
| Contact material (relay) | AgCe + Au |
| Limiting continuous current | 5 A |
| Max. make current (resistive) | (AC) 15 A / 4 s |
| Max. switching voltage | AC 250 V |
| Max. switching power (resistive) | AC 1250 VA; DC (see load limit curve) |
| Recommended minimum load | 5 V / 1 mA / 50 mW |
| Pull-in time (typ.) | 25 ms |
| Drop-out time (typ.) | 25 ms |
| Bounce time (typ) | 4 ms |
| Electrical life (N.O.; resistive load; 23 °C) | 100 x 10 ³ switching operations |
| Mechanical life | 20 x 10 ⁶ switching operations |

Signaling

| | |
|-------------------|-----------------------|
| Status indication | Red LED Mechanical |
|-------------------|-----------------------|

Safety and protection:

| | |
|-----------------------|--------|
| Rated voltage | 250 V |
| Rated impulse voltage | 2.5 kV |

Subject to changes. Please also observe the further product documentation!



| | |
|---|-----------|
| Pollution degree | 2 |
| Dielectric strength, control/load circuit (AC, 1 min) | 1,5 kVrms |
| Dielectric strength open contact (AC, 1 min) | 1 kVrms |
| Dielectric strength, load/load circuit (AC, 1 min) | 1,5 kVrms |
| Protection class | IP20 |

Connection data

| | |
|--------------------------------|--|
| Connection technology | Push-in CAGE CLAMP® |
| Solid conductor | 0,34 ... 1,5 mm ² / 22 ... 16 AWG |
| Fine-stranded conductor | 0,34 ... 1,5 mm ² / 22 ... 16 AWG |
| Strip length | 9 ... 10 mm / 0.35 ... 0.39 inch |
| Note (conductor cross-section) | 2 x 0.34 ... 2 x 1.5 mm ² / 1 x 2.5 mm ² / 2 x 22 ... 2 x 16 AWG |

Geometrical Data

| | |
|---------------------------------------|--------------------|
| Width | 31 mm / 1.22 inch |
| Height from upper-edge of DIN-35 rail | 73 mm / 2.874 inch |
| Depth | 97 mm / 3.819 inch |

Mechanical data

| | |
|------------------|-------------|
| Type of mounting | DIN-35 rail |
|------------------|-------------|

Material Data

| | |
|-----------|----------|
| Fire load | 1.225 MJ |
| Weight | 97.5 g |

Environmental Requirements

| | |
|--|----------------|
| Surrounding air (operating) temperature at U _N | -25 ... 70 °C |
| Surrounding air (operating) temperature for UL at U _N | -25 ... 50 °C |
| Surrounding air (storage) temperature | -40 ... 80 °C |
| Processing temperature | -25 ... +50 °C |

Standards and specifications

| | |
|--------------------------|---|
| Standards/specifications | EN 61010-2-201; EN 61810-1; EN 61373; GL; UL 508 (max. 50 °C) |
|--------------------------|---|

Subject to changes. Please also observe the further product documentation!

Elementary relay



WAGO elementary relay 858-152

Commercial data

| | |
|--------------------|---------------------------|
| Product Group | 6 (Interface Electronics) |
| Packaging type | BOX |
| Country of origin | DE |
| GTIN | 4055143567893 |
| Customs Tariff No. | 85364900990 |

Approvals / Certificates

Ship Approvals

| Logo | Approval | Additional Approval Text | Certificate name |
|---|---|--------------------------|-----------------------|
|  | DNV GL Det Norske Veritas, Germanischer Lloyd | - | TAA00001D1 |
|  | NK Nippon Kaiji Kyokai | - | TA17255M |
|  | PRS Polski Rejestr Statków | - | TE/2186 /880590/18 |

UL-Approvals

| Logo | Approval | Additional Approval Text | Certificate name |
|--|---|--------------------------|------------------|
|  | UL UL International Netherlands B.V. (ORDINARY LOCATIONS) | UL 508 | E175199 Sec.6 |

Counterpart

Subject to changes. Please also observe the further product documentation!

WAGO Kontakttechnik GmbH & Co. KG
Hansastr. 27
32423 Minden
Phone: +49571 887-0 | Fax: +49571 887-169
Email: info.de@wago.com | Web: www.wago.com

Do you have any questions about our products?
We are always happy to take your call at +49 (571) 887-44222.

Compatible products

tools

**Item no.: 210-719**

Operating tool; Blade: 2.5 x 0.4 mm; with a partially insulated shaft

www.wago.com/210-719

ferrule

**Item no.: 216-241**Ferrule; Sleeve for 0.5 mm² / 20 AWG; insulated; electro-tin plated; electrolytic copper; gastight crimped; acc. to DIN 46228, Part 4/09.90; whitewww.wago.com/216-241**Item no.: 216-242**Ferrule; Sleeve for 0.75 mm² / 18 AWG; insulated; electro-tin plated; electrolytic copper; gastight crimped; acc. to DIN 46228, Part 4/09.90; graywww.wago.com/216-242**Item no.: 216-243**Ferrule; Sleeve for 1 mm² / AWG 18; insulated; electro-tin plated; electrolytic copper; gastight crimped; acc. to DIN 46228, Part 4/09.90; redwww.wago.com/216-243**Item no.: 216-244**Ferrule; Sleeve for 1.5 mm² / AWG 16; insulated; electro-tin plated; electrolytic copper; gastight crimped; acc. to DIN 46228, Part 4/09.90; blackwww.wago.com/216-244

General accessories

**Item no.: 209-145**

Group marker carrier; white

www.wago.com/209-145**Item no.: 209-184**

Protection cover; transparent

www.wago.com/209-184**Item no.: 788-120**

Accessories for relay modules; Operation status indicator: red

www.wago.com/788-120**Item no.: 858-110**

Mounting bracket

www.wago.com/858-110**Item no.: 858-152**

Basic relay; Nominal input voltage: 24 VDC; 4 changeover contacts; Limiting continuous current: 5 A; with gold contacts; with manual operation; Module width: 22 mm; Module height: 25 mm

www.wago.com/858-152

Marking accessories

**Item no.: 2009-110**

Marking strips; on reel; not stretchable; plain; snap-on type; white

www.wago.com/2009-110**Item no.: 2009-115**

WMB-Inline; for Smart Printer; 1500 pieces on roll; stretchable 5 - 5.2 mm; plain; snap-on type; white

www.wago.com/2009-115**Item no.: 2009-115/000-002**

WMB-Inline; for Smart Printer; 1500 pieces on roll; stretchable 5 - 5.2 mm; plain; snap-on type; yellow

www.wago.com/2009-115

/000-002

Subject to changes. Please also observe the further product documentation!

WAGO Kontakttechnik GmbH & Co. KG

Hansastr. 27















32423 Minden

Phone: +49571 887-0 | Fax: +49571 887-169













Email: info.de@wago.com | Web: www.wago.com

Do you have any questions about our products?















We are always happy to take your call at +49 (571) 887-44222.

| | | |
|--|---|--|
|  | Item no.: 2009-115/000-006 WMB-Inline; for Smart Printer; 1500 pieces on roll; stretchable 5 - 5.2 mm; plain; snap-on type; blue | www.wago.com/2009-115/000-006 |
|  | Item no.: 2009-115/000-007 WMB-Inline; for Smart Printer; 1500 pieces on roll; stretchable 5 - 5.2 mm; plain; snap-on type; gray | www.wago.com/2009-115/000-007 |
|  | Item no.: 2009-115/000-012 WMB-Inline; for Smart Printer; 1500 pieces on roll; stretchable 5 - 5.2 mm; plain; snap-on type; orange | www.wago.com/2009-115/000-012 |
|  | Item no.: 2009-115/000-017 WMB-Inline; for Smart Printer; 1500 pieces on roll; stretchable 5 - 5.2 mm; plain; snap-on type; light green | www.wago.com/2009-115/000-017 |
|  | Item no.: 2009-115/000-023 WMB-Inline; for Smart Printer; 1500 pieces on roll; stretchable 5 - 5.2 mm; plain; snap-on type; green | www.wago.com/2009-115/000-023 |
|  | Item no.: 2009-115/000-024 WMB-Inline; for Smart Printer; 1500 pieces on roll; stretchable 5 - 5.2 mm; plain; snap-on type; violet | www.wago.com/2009-115/000-024 |
|  | Item no.: 209-128 Adaptor; gray | www.wago.com/209-128 |
|  | Item no.: 209-183 Marker card; white | www.wago.com/209-183 |
|  | Item no.: 210-110 Fiber-tip pen | www.wago.com/210-110 |
|  | Item no.: 249-105 Group marker carrier; gray | www.wago.com/249-105 |
|  | Item no.: 793-501 WMB marking card; as card; not stretchable; plain; snap-on type; white | www.wago.com/793-501 |
|  | Item no.: 793-501/000-002 WMB marking card; as card; not stretchable; plain; snap-on type; yellow | www.wago.com/793-501/000-002 |
|  | Item no.: 793-501/000-005 WMB marking card; as card; not stretchable; plain; snap-on type; red | www.wago.com/793-501/000-005 |
|  | Item no.: 793-501/000-006 WMB marking card; as card; not stretchable; plain; snap-on type; blue | www.wago.com/793-501/000-006 |
|  | Item no.: 793-501/000-007 WMB marking card; as card; not stretchable; plain; snap-on type; gray | www.wago.com/793-501/000-007 |















Subject to changes. Please also observe the further product documentation!

| | | |
|--|---|--|
|  | Item no.: 793-501/000-012 WMB marking card; as card; not stretchable; plain; snap-on type; orange | www.wago.com/793-501/000-012 |
|  | Item no.: 793-501/000-017 WMB marking card; as card; not stretchable; plain; snap-on type; light green | www.wago.com/793-501/000-017 |
|  | Item no.: 793-501/000-023 WMB marking card; as card; not stretchable; plain; snap-on type; green | www.wago.com/793-501/000-023 |
|  | Item no.: 793-501/000-024 WMB marking card; as card; not stretchable; plain; snap-on type; violet | www.wago.com/793-501/000-024 |
|  | Item no.: 793-502 WMB marking card; as card; MARKED; 1 ... 10 (10x); not stretchable; Horizontal marking; snap-on type; white | www.wago.com/793-502 |
|  | Item no.: 793-502/000-002 WMB marking card; as card; MARKED; 1 ... 10 (10x); not stretchable; Horizontal marking; snap-on type; yellow | www.wago.com/793-502/000-002 |
|  | Item no.: 793-502/000-005 WMB marking card; as card; MARKED; 1 ... 10 (10x); not stretchable; Horizontal marking; snap-on type; red | www.wago.com/793-502/000-005 |
|  | Item no.: 793-502/000-006 WMB marking card; as card; MARKED; 1 ... 10 (10x); not stretchable; Horizontal marking; snap-on type; blue | www.wago.com/793-502/000-006 |
|  | Item no.: 793-502/000-007 WMB marking card; as card; MARKED; 1 ... 10 (10x); not stretchable; Horizontal marking; snap-on type; gray | www.wago.com/793-502/000-007 |
|  | Item no.: 793-502/000-012 WMB marking card; as card; MARKED; 1 ... 10 (10x); not stretchable; Horizontal marking; snap-on type; orange | www.wago.com/793-502/000-012 |
|  | Item no.: 793-502/000-017 WMB marking card; as card; MARKED; 1 ... 10 (10x); not stretchable; Horizontal marking; snap-on type; light green | www.wago.com/793-502/000-017 |
|  | Item no.: 793-502/000-023 WMB marking card; as card; MARKED; 1 ... 10 (10x); not stretchable; Horizontal marking; snap-on type; green | www.wago.com/793-502/000-023 |
|  | Item no.: 793-502/000-024 WMB marking card; as card; MARKED; 1 ... 10 (10x); not stretchable; Horizontal marking; snap-on type; violet | www.wago.com/793-502/000-024 |
| | Item no.: 793-503 | |













Subject to changes. Please also observe the further product documentation!

| | | |
|--|--|--|
|  | WMB marking card; as card; MARKED; 11 ... 20 (10x); not stretchable; Horizontal marking; snap-on type; white | www.wago.com/793-503 |
|  | Item no.: 793-503/000-002 WMB marking card; as card; MARKED; 11 ... 20 (10x); not stretchable; Horizontal marking; snap-on type; yellow | www.wago.com/793-503/000-002 |
|  | Item no.: 793-503/000-005 WMB marking card; as card; MARKED; 11 ... 20 (10x); not stretchable; Horizontal marking; snap-on type; red | www.wago.com/793-503/000-005 |
|  | Item no.: 793-503/000-006 WMB marking card; as card; MARKED; 11 ... 20 (10x); not stretchable; Horizontal marking; snap-on type; blue | www.wago.com/793-503/000-006 |
|  | Item no.: 793-503/000-007 WMB marking card; as card; MARKED; 11 ... 20 (10x); not stretchable; Horizontal marking; snap-on type; gray | www.wago.com/793-503/000-007 |
|  | Item no.: 793-503/000-012 WMB marking card; as card; MARKED; 11 ... 20 (10x); not stretchable; Horizontal marking; snap-on type; orange | www.wago.com/793-503/000-012 |
|  | Item no.: 793-503/000-017 WMB marking card; as card; MARKED; 11 ... 20 (10x); not stretchable; Horizontal marking; snap-on type; light green | www.wago.com/793-503/000-017 |
|  | Item no.: 793-503/000-023 WMB marking card; as card; MARKED; 11 ... 20 (10x); not stretchable; Horizontal marking; snap-on type; green | www.wago.com/793-503/000-023 |
|  | Item no.: 793-503/000-024 WMB marking card; as card; MARKED; 11 ... 20 (10x); not stretchable; Horizontal marking; snap-on type; violet | www.wago.com/793-503/000-024 |
|  | Item no.: 793-504 WMB marking card; as card; MARKED; 21 ... 30 (10x); not stretchable; Horizontal marking; snap-on type; white | www.wago.com/793-504 |
|  | Item no.: 793-504/000-002 WMB marking card; as card; MARKED; 21 ... 30 (10x); not stretchable; Horizontal marking; snap-on type; yellow | www.wago.com/793-504/000-002 |
|  | Item no.: 793-504/000-005 WMB marking card; as card; MARKED; 21 ... 30 (10x); not stretchable; Horizontal marking; snap-on type; red | www.wago.com/793-504/000-005 |
|  | Item no.: 793-504/000-006 WMB marking card; as card; MARKED; 21 ... 30 (10x); not stretchable; Horizontal marking; snap-on type; blue | www.wago.com/793-504/000-006 |
|  | Item no.: 793-504/000-012 WMB marking card; as card; MARKED; 21 ... 30 (10x); not stretchable; Horizontal marking; snap-on type; orange | www.wago.com/793-504/000-012 |

Subject to changes. Please also observe the further product documentation!

| | | |
|--|---|--|
|  | Item no.: 793-504/000-017 WMB marking card; as card; MARKED; 21 ... 30 (10x); not stretchable; Horizontal marking; snap-on type; light green | www.wago.com/793-504/000-017 |
|  | Item no.: 793-504/000-023 WMB marking card; as card; MARKED; 21 ... 30 (10x); not stretchable; Horizontal marking; snap-on type; green | www.wago.com/793-504/000-023 |
|  | Item no.: 793-505 WMB marking card; as card; MARKED; 31 ... 40 (10x); not stretchable; Horizontal marking; snap-on type; white | www.wago.com/793-505 |
|  | Item no.: 793-505/000-005 WMB marking card; as card; MARKED; 31 ... 40 (10x); not stretchable; Horizontal marking; snap-on type; red | www.wago.com/793-505/000-005 |
|  | Item no.: 793-505/000-006 WMB marking card; as card; MARKED; 31 ... 40 (10x); not stretchable; Horizontal marking; snap-on type; blue | www.wago.com/793-505/000-006 |
|  | Item no.: 793-505/000-007 WMB marking card; as card; MARKED; 31 ... 40 (10x); not stretchable; Horizontal marking; snap-on type; gray | www.wago.com/793-505/000-007 |
|  | Item no.: 793-505/000-012 WMB marking card; as card; MARKED; 31 ... 40 (10x); not stretchable; Horizontal marking; snap-on type; orange | www.wago.com/793-505/000-012 |
|  | Item no.: 793-506 WMB marking card; as card; MARKED; 41 ... 50 (10x); not stretchable; Horizontal marking; snap-on type; white | www.wago.com/793-506 |
|  | Item no.: 793-506/000-005 WMB marking card; as card; MARKED; 41 ... 50 (10x); not stretchable; Horizontal marking; snap-on type; red | www.wago.com/793-506/000-005 |
|  | Item no.: 793-506/000-006 WMB marking card; as card; MARKED; 41 ... 50 (10x); not stretchable; Horizontal marking; snap-on type; blue | www.wago.com/793-506/000-006 |
|  | Item no.: 793-506/000-012 WMB marking card; as card; MARKED; 41 ... 50 (10x); not stretchable; Horizontal marking; snap-on type; orange | www.wago.com/793-506/000-012 |
|  | Item no.: 793-506/000-017 WMB marking card; as card; MARKED; 41 ... 50 (10x); not stretchable; Horizontal marking; snap-on type; light green | www.wago.com/793-506/000-017 |
|  | Item no.: 793-5501 WMB marking card; as card; for terminal block width 5 - 17.5 mm; stretchable 5 - 5.2 mm; plain; snap-on type; white | www.wago.com/793-5501 |
|  | Item no.: 793-5501/000-002 WMB marking card; as card; for terminal block width 5 - 17.5 mm; stretchable 5 - 5.2 mm; plain; snap-on type; yellow | www.wago.com/793-5501/000-002 |

Subject to changes. Please also observe the further product documentation!

| | | |
|--|--|--|
|  | Item no.: 793-5501/000-005 WMB marking card; as card; for terminal block width 5 - 17.5 mm; stretchable 5 - 5.2 mm; plain; snap-on type; red | www.wago.com/793-5501/000-005 |
|  | Item no.: 793-5501/000-006 WMB marking card; as card; for terminal block width 5 - 17.5 mm; stretchable 5 - 5.2 mm; plain; snap-on type; blue | www.wago.com/793-5501/000-006 |
|  | Item no.: 793-5501/000-007 WMB marking card; as card; for terminal block width 5 - 17.5 mm; stretchable 5 - 5.2 mm; plain; snap-on type; gray | www.wago.com/793-5501/000-007 |
|  | Item no.: 793-5501/000-012 WMB marking card; as card; for terminal block width 5 - 17.5 mm; stretchable 5 - 5.2 mm; plain; snap-on type; orange | www.wago.com/793-5501/000-012 |
|  | Item no.: 793-5501/000-014 WMB marking card; as card; for terminal block width 5 - 17.5 mm; stretchable 5 - 5.2 mm; plain; snap-on type; brown | www.wago.com/793-5501/000-014 |
|  | Item no.: 793-5501/000-017 WMB marking card; as card; for terminal block width 5 - 17.5 mm; stretchable 5 - 5.2 mm; plain; snap-on type; green | www.wago.com/793-5501/000-017 |
|  | Item no.: 793-5501/000-023 WMB marking card; as card; for terminal block width 5 - 17.5 mm; stretchable 5 - 5.2 mm; plain; snap-on type; light green | www.wago.com/793-5501/000-023 |
|  | Item no.: 793-5501/000-024 WMB marking card; as card; for terminal block width 5 - 17.5 mm; stretchable 5 - 5.2 mm; plain; snap-on type; violet | www.wago.com/793-5501/000-024 |
|  | Item no.: 793-566 WMB marking card; as card; MARKED; 1 ... 50 (2x); not stretchable; Horizontal marking; snap-on type; white | www.wago.com/793-566 |
|  | Item no.: 793-566/000-002 WMB marking card; as card; MARKED; 1 ... 50 (2x); not stretchable; Horizontal marking; snap-on type; yellow | www.wago.com/793-566/000-002 |
|  | Item no.: 793-566/000-005 WMB marking card; as card; MARKED; 1 ... 50 (2x); not stretchable; Horizontal marking; snap-on type; red | www.wago.com/793-566/000-005 |
|  | Item no.: 793-566/000-006 WMB marking card; as card; MARKED; 1 ... 50 (2x); not stretchable; Horizontal marking; snap-on type; blue | www.wago.com/793-566/000-006 |
|  | Item no.: 793-566/000-007 WMB marking card; as card; MARKED; 1 ... 50 (2x); not stretchable; Horizontal marking; snap-on type; gray | www.wago.com/793-566/000-007 |
| | Item no.: 793-566/000-012 | |

Subject to changes. Please also observe the further product documentation!



WMB marking card; as card; MARKED; 1 ... 50 (2x); not stretchable; Horizontal marking; snap-on type; orange

www.wago.com/793-566/000-012



Item no.: 793-566/000-017

WMB marking card; as card; MARKED; 1 ... 50 (2x); not stretchable; Horizontal marking; snap-on type; light green

www.wago.com/793-566/000-017



Item no.: 793-566/000-023

WMB marking card; as card; MARKED; 1 ... 50 (2x); not stretchable; Horizontal marking; snap-on type; green

www.wago.com/793-566/000-023



Item no.: 793-566/000-024

WMB marking card; as card; MARKED; 1 ... 50 (2x); not stretchable; Horizontal marking; snap-on type; violet

www.wago.com/793-566/000-024

Jumper



Item no.: 858-402

Push-in type jumper bar; for the coil side

www.wago.com/858-402

Downloads

Documentation

Bid Text

| | | | |
|------------------------------|--------------|-----------------|----------|
| 858-314 GAEB docx - Datei | Feb 20, 2019 | docx 17.5 kB | Download |
| 858-314 GAEB X81 - Datei | Feb 19, 2019 | xml 5.2 kB | Download |

Instruction Leaflet

| | | | |
|---------------------------------|--|---------------|----------|
| Stecksockel für Elementarrelais | | pdf 2.6 MB | Download |
|---------------------------------|--|---------------|----------|

Additional Information

| | | | |
|--|---------|-----------------|----------|
| Disposal; Electrical and electronic equipment, Packaging | V 1.0.0 | pdf 265.8 kB | Download |
|--|---------|-----------------|----------|

CAD/CAE-Data

CAD data

| | | | |
|----------------------|--|-----|----------|
| 2D/3D Models 858-314 | | URL | Download |
|----------------------|--|-----|----------|

Subject to changes. Please also observe the further product documentation!

CAE data

EPLAN Data Portal 858-314

URL

Download

WSCAD Universe 858-314

URL

Download

Installation Notes

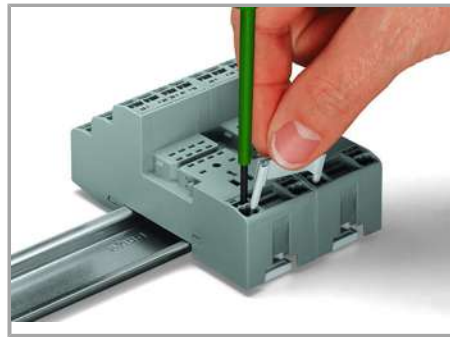
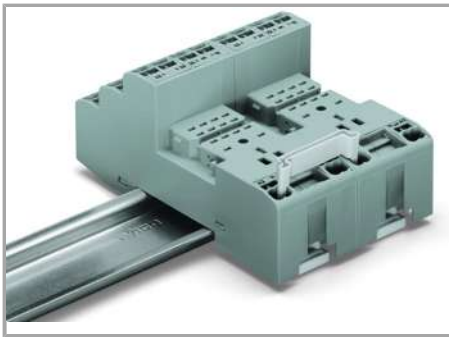

Remove jumper with screwdriver.

Marking

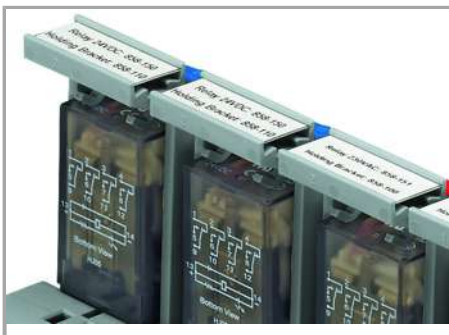

Marking using WMB Multi markers and group marker carriers

Subject to changes. Please also observe the further product documentation!