

Data sheet | Item number: 858-508

Relay module; Nominal input voltage: 230 VAC; 4 changeover contacts;
Limiting continuous current: 5 A; with manual operation; Red status indicator;
Module width: 31 mm; 1,50 mm²

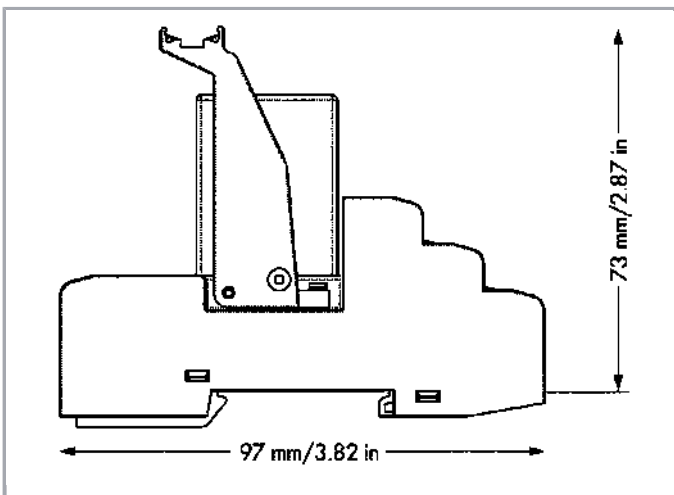

www.wago.com/858-508

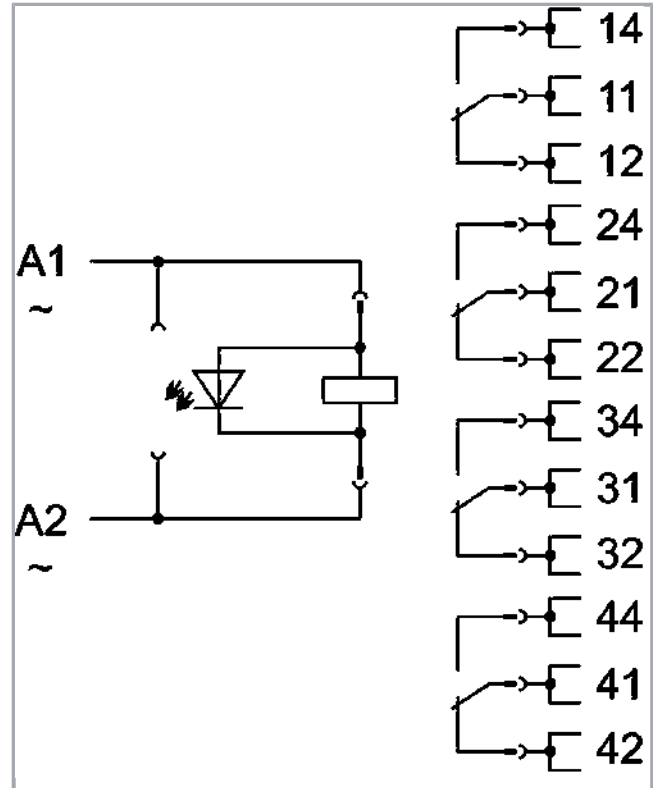

Subject to changes. Please also observe the further product documentation!

WAGO Kontakttechnik GmbH & Co. KG
Hansastr. 27
32423 Minden
Phone: +49571 887-0 | Fax: +49571 887-169
Email: info.de@wago.com | Web: www.wago.com

Do you have any questions about our products?
We are always happy to take your call at +49 (571) 887-44222.

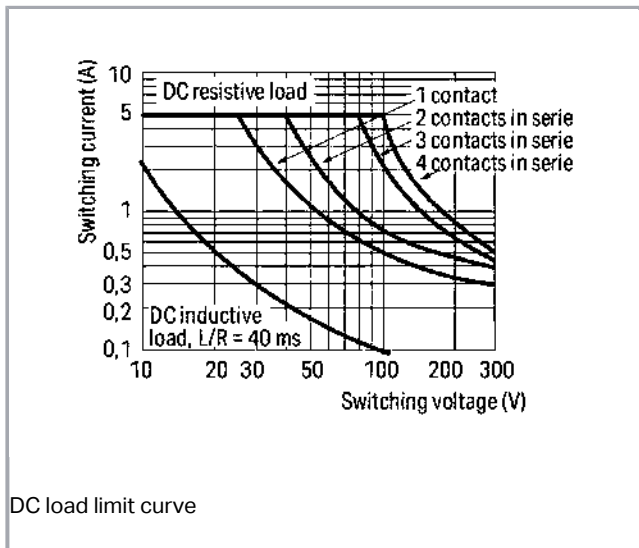

Data

Technical Data

Control circuit

Nominal input voltage U_N	AC 230 V
Input voltage range	-20 ... +10 %
Nominal input current at U_N	8,3 mA

Load circuit:

Number of changeover/switchover contacts	4
Contact material (relay)	AgCe
Limiting continuous current	5 A
Max. make current (resistive)	(AC) 15 A / 4 s
Max. switching voltage	AC 250 V
Max. switching power (resistive)	AC 1250 VA; DC (see load limit curve)
Recommended minimum load	12 V / 100 mA
Pull-in time (typ.)	25 ms
Drop-out time (typ.)	35 ms
Bounce time (typ.)	4 ms
Electrical life (N.O.; resistive load; 23 °C)	100×10^3 switching operations
Mechanical life	20×10^6 switching operations

Subject to changes. Please also observe the further product documentation!



Signaling

Status indication	Red LED Mechanical
-------------------	-----------------------

Safety and protection:

Rated voltage	250 V
Rated impulse voltage	2.5 kV
Pollution degree	2
Dielectric strength, control/load circuit (AC, 1 min)	1,5 kVrms
Dielectric strength open contact (AC, 1 min)	1 kVrms
Dielectric strength, load/load circuit (AC, 1 min)	1,5 kVrms
Protection class	IP20

Connection data

Connection technology	Push-in CAGE CLAMP®
Solid conductor	0,34 ... 1,5 mm ² / 22 ... 16 AWG
Fine-stranded conductor	0,34 ... 1,5 mm ² / 22 ... 16 AWG
Strip length	9 ... 10 mm / 0.35 ... 0.39 inch
Note (conductor cross-section)	2 x 0.34 ... 2 x 1.5 mm ² / 1 x 2.5 mm ² / 2 x 22 ... 2 x 16 AWG

Geometrical Data

Width	31 mm / 1.22 inch
Height from upper-edge of DIN-35 rail	73 mm / 2.874 inch
Depth	97 mm / 3.819 inch

Mechanical data

Type of mounting	DIN-35 rail
------------------	-------------

Material Data

Fire load	1.225 MJ
Weight	98 g

Environmental Requirements

Surrounding air (operating) temperature at U _N	-25 ... 70 °C
Surrounding air (operating) temperature for UL at U _N	-25 ... 50 °C

Subject to changes. Please also observe the further product documentation!

WAGO Kontakttechnik GmbH & Co. KG
 Hansastr. 27
 32423 Minden
 Phone: +49571 887-0 | Fax: +49571 887-169
 Email: info.de@wago.com | Web: www.wago.com

Do you have any questions about our products?
 We are always happy to take your call at +49 (571) 887-44222.

Surrounding air (storage) temperature	-40 ... 80 °C
Processing temperature	-25 ... +50 °C

Standards and specifications

Standards/specifications	EN 61010-2-201; EN 61810-1; EN 61373; GL; UL 508 (max. 50 °C)
--------------------------	---

Elementary relay



WAGO elementary relay	858-151
-----------------------	---------

Commercial data

Product Group	6 (Interface Electronics)
Packaging type	BOX
Country of origin	DE
GTIN	4055143568340
Customs Tariff No.	85364900990

Approvals / Certificates

Ship Approvals

Logo	Approval	Additional Approval Text	Certificate name
	DNV GL Det Norske Veritas, Germanischer Lloyd	-	TAA00001D1
	NK Nippon Kaiji Kyokai	-	TA17255M
	PRS Polski Rejestr Statków	-	TE/2186 /880590/18

UL-Approvals

Logo	Approval	Additional Approval Text	Certificate name
	UL UL International Netherlands B.V. (ORDINARY LOCATIONS)	UL 508	E175199 Sec.6

Subject to changes. Please also observe the further product documentation!

Counterpart

Compatible products

Jumper



Item no.: 858-402

Push-in type jumper bar; for the coil side

www.wago.com/858-402

General accessories



Item no.: 209-145

Group marker carrier; white

www.wago.com/209-145



Item no.: 209-184

Protection cover; transparent

www.wago.com/209-184



Item no.: 788-125

Accessories for relay modules; Operation status indicator: red

www.wago.com/788-125



Item no.: 788-148

Filter module; RC filter element; Nominal voltage: 230 VAC

www.wago.com/788-148



Item no.: 858-110

Mounting bracket

www.wago.com/858-110



Item no.: 858-151

Basic relay; Nominal input voltage: 230 VAC; 4 changeover contacts; Limiting continuous current: 5 A; with manual operation; Module width: 22 mm; Module height: 25 mm

www.wago.com/858-151

Marking accessories



Item no.: 2009-110

Marking strips; on reel; not stretchable; plain; snap-on type; white

www.wago.com/2009-110



Item no.: 2009-115

WMB-Inline; for Smart Printer; 1500 pieces on roll; stretchable 5 - 5.2 mm; plain; snap-on type; white

www.wago.com/2009-115



Item no.: 2009-115/000-002

WMB-Inline; for Smart Printer; 1500 pieces on roll; stretchable 5 - 5.2 mm; plain; snap-on type; yellow

www.wago.com/2009-115/000-002



Item no.: 2009-115/000-006

WMB-Inline; for Smart Printer; 1500 pieces on roll; stretchable 5 - 5.2 mm; plain; snap-on type; blue

www.wago.com/2009-115/000-006

Subject to changes. Please also observe the further product documentation!

WAGO Kontakttechnik GmbH & Co. KG

Hansastr. 27















32423 Minden

Phone: +49571 887-0 | Fax: +49571 887-169













Email: info.de@wago.com | Web: www.wago.com

Do you have any questions about our products?

We are always happy to take your call at +49 (571) 887-44222.

	Item no.: 2009-115/000-007 WMB-Inline; for Smart Printer; 1500 pieces on roll; stretchable 5 - 5.2 mm; plain; snap-on type; gray	www.wago.com/2009-115/000-007
	Item no.: 2009-115/000-012 WMB-Inline; for Smart Printer; 1500 pieces on roll; stretchable 5 - 5.2 mm; plain; snap-on type; orange	www.wago.com/2009-115/000-012
	Item no.: 2009-115/000-017 WMB-Inline; for Smart Printer; 1500 pieces on roll; stretchable 5 - 5.2 mm; plain; snap-on type; light green	www.wago.com/2009-115/000-017
	Item no.: 2009-115/000-023 WMB-Inline; for Smart Printer; 1500 pieces on roll; stretchable 5 - 5.2 mm; plain; snap-on type; green	www.wago.com/2009-115/000-023
	Item no.: 2009-115/000-024 WMB-Inline; for Smart Printer; 1500 pieces on roll; stretchable 5 - 5.2 mm; plain; snap-on type; violet	www.wago.com/2009-115/000-024
	Item no.: 209-128 Adaptor; gray	www.wago.com/209-128
	Item no.: 209-183 Marker card; white	www.wago.com/209-183
	Item no.: 210-110 Fiber-tip pen	www.wago.com/210-110
	Item no.: 249-105 Group marker carrier; gray	www.wago.com/249-105
	Item no.: 793-501 WMB marking card; as card; not stretchable; plain; snap-on type; white	www.wago.com/793-501
	Item no.: 793-501/000-002 WMB marking card; as card; not stretchable; plain; snap-on type; yellow	www.wago.com/793-501/000-002
	Item no.: 793-501/000-005 WMB marking card; as card; not stretchable; plain; snap-on type; red	www.wago.com/793-501/000-005
	Item no.: 793-501/000-006 WMB marking card; as card; not stretchable; plain; snap-on type; blue	www.wago.com/793-501/000-006
	Item no.: 793-501/000-007 WMB marking card; as card; not stretchable; plain; snap-on type; gray	www.wago.com/793-501/000-007
	Item no.: 793-501/000-012 WMB marking card; as card; not stretchable; plain; snap-on type; orange	www.wago.com/793-501/000-012

Subject to changes. Please also observe the further product documentation!

	Item no.: 793-501/000-017 WMB marking card; as card; not stretchable; plain; snap-on type; light green	www.wago.com/793-501/000-017
	Item no.: 793-501/000-023 WMB marking card; as card; not stretchable; plain; snap-on type; green	www.wago.com/793-501/000-023
	Item no.: 793-501/000-024 WMB marking card; as card; not stretchable; plain; snap-on type; violet	www.wago.com/793-501/000-024
	Item no.: 793-502 WMB marking card; as card; MARKED; 1 ... 10 (10x); not stretchable; Horizontal marking; snap-on type; white	www.wago.com/793-502
	Item no.: 793-502/000-002 WMB marking card; as card; MARKED; 1 ... 10 (10x); not stretchable; Horizontal marking; snap-on type; yellow	www.wago.com/793-502/000-002
	Item no.: 793-502/000-005 WMB marking card; as card; MARKED; 1 ... 10 (10x); not stretchable; Horizontal marking; snap-on type; red	www.wago.com/793-502/000-005
	Item no.: 793-502/000-006 WMB marking card; as card; MARKED; 1 ... 10 (10x); not stretchable; Horizontal marking; snap-on type; blue	www.wago.com/793-502/000-006
	Item no.: 793-502/000-007 WMB marking card; as card; MARKED; 1 ... 10 (10x); not stretchable; Horizontal marking; snap-on type; gray	www.wago.com/793-502/000-007
	Item no.: 793-502/000-012 WMB marking card; as card; MARKED; 1 ... 10 (10x); not stretchable; Horizontal marking; snap-on type; orange	www.wago.com/793-502/000-012
	Item no.: 793-502/000-017 WMB marking card; as card; MARKED; 1 ... 10 (10x); not stretchable; Horizontal marking; snap-on type; light green	www.wago.com/793-502/000-017
	Item no.: 793-502/000-023 WMB marking card; as card; MARKED; 1 ... 10 (10x); not stretchable; Horizontal marking; snap-on type; green	www.wago.com/793-502/000-023
	Item no.: 793-502/000-024 WMB marking card; as card; MARKED; 1 ... 10 (10x); not stretchable; Horizontal marking; snap-on type; violet	www.wago.com/793-502/000-024
	Item no.: 793-503 WMB marking card; as card; MARKED; 11 ... 20 (10x); not stretchable; Horizontal marking; snap-on type; white	www.wago.com/793-503

Subject to changes. Please also observe the further product documentation!



Item no.: 793-503/000-002

WMB marking card; as card; MARKED; 11 ... 20 (10x); not stretchable; Horizontal marking; snap-on type; yellow www.wago.com/793-503/000-002



Item no.: 793-503/000-005

WMB marking card; as card; MARKED; 11 ... 20 (10x); not stretchable; Horizontal marking; snap-on type; red www.wago.com/793-503/000-005



Item no.: 793-503/000-006

WMB marking card; as card; MARKED; 11 ... 20 (10x); not stretchable; Horizontal marking; snap-on type; blue www.wago.com/793-503/000-006



Item no.: 793-503/000-007

WMB marking card; as card; MARKED; 11 ... 20 (10x); not stretchable; Horizontal marking; snap-on type; gray www.wago.com/793-503/000-007



Item no.: 793-503/000-012

WMB marking card; as card; MARKED; 11 ... 20 (10x); not stretchable; Horizontal marking; snap-on type; orange www.wago.com/793-503/000-012



Item no.: 793-503/000-017

WMB marking card; as card; MARKED; 11 ... 20 (10x); not stretchable; Horizontal marking; snap-on type; light green www.wago.com/793-503/000-017



Item no.: 793-503/000-023

WMB marking card; as card; MARKED; 11 ... 20 (10x); not stretchable; Horizontal marking; snap-on type; green www.wago.com/793-503/000-023



Item no.: 793-503/000-024

WMB marking card; as card; MARKED; 11 ... 20 (10x); not stretchable; Horizontal marking; snap-on type; violet www.wago.com/793-503/000-024



Item no.: 793-504

WMB marking card; as card; MARKED; 21 ... 30 (10x); not stretchable; Horizontal marking; snap-on type; white www.wago.com/793-504



Item no.: 793-504/000-002

WMB marking card; as card; MARKED; 21 ... 30 (10x); not stretchable; Horizontal marking; snap-on type; yellow www.wago.com/793-504/000-002



Item no.: 793-504/000-005

WMB marking card; as card; MARKED; 21 ... 30 (10x); not stretchable; Horizontal marking; snap-on type; red www.wago.com/793-504/000-005



Item no.: 793-504/000-006

WMB marking card; as card; MARKED; 21 ... 30 (10x); not stretchable; Horizontal marking; snap-on type; blue www.wago.com/793-504/000-006

















Item no.: 793-504/000-012













WMB marking card; as card; MARKED; 21 ... 30 (10x); not stretchable; Horizontal marking; snap-on type; orange www.wago.com/793-504/000-012

Item no.: 793-504/000-017

Subject to changes. Please also observe the further product documentation!

	WMB marking card; as card; MARKED; 21 ... 30 (10x); not stretchable; Horizontal marking; snap-on type; light green	www.wago.com/793-504/000-017
	Item no.: 793-504/000-023 WMB marking card; as card; MARKED; 21 ... 30 (10x); not stretchable; Horizontal marking; snap-on type; green	www.wago.com/793-504/000-023
	Item no.: 793-505 WMB marking card; as card; MARKED; 31 ... 40 (10x); not stretchable; Horizontal marking; snap-on type; white	www.wago.com/793-505
	Item no.: 793-505/000-005 WMB marking card; as card; MARKED; 31 ... 40 (10x); not stretchable; Horizontal marking; snap-on type; red	www.wago.com/793-505/000-005
	Item no.: 793-505/000-006 WMB marking card; as card; MARKED; 31 ... 40 (10x); not stretchable; Horizontal marking; snap-on type; blue	www.wago.com/793-505/000-006
	Item no.: 793-505/000-007 WMB marking card; as card; MARKED; 31 ... 40 (10x); not stretchable; Horizontal marking; snap-on type; gray	www.wago.com/793-505/000-007
	Item no.: 793-505/000-012 WMB marking card; as card; MARKED; 31 ... 40 (10x); not stretchable; Horizontal marking; snap-on type; orange	www.wago.com/793-505/000-012
	Item no.: 793-506 WMB marking card; as card; MARKED; 41 ... 50 (10x); not stretchable; Horizontal marking; snap-on type; white	www.wago.com/793-506
	Item no.: 793-506/000-005 WMB marking card; as card; MARKED; 41 ... 50 (10x); not stretchable; Horizontal marking; snap-on type; red	www.wago.com/793-506/000-005
	Item no.: 793-506/000-006 WMB marking card; as card; MARKED; 41 ... 50 (10x); not stretchable; Horizontal marking; snap-on type; blue	www.wago.com/793-506/000-006
	Item no.: 793-506/000-012 WMB marking card; as card; MARKED; 41 ... 50 (10x); not stretchable; Horizontal marking; snap-on type; orange	www.wago.com/793-506/000-012
	Item no.: 793-506/000-017 WMB marking card; as card; MARKED; 41 ... 50 (10x); not stretchable; Horizontal marking; snap-on type; light green	www.wago.com/793-506/000-017
	Item no.: 793-5501 WMB marking card; as card; for terminal block width 5 - 17.5 mm; stretchable 5 - 5.2 mm; plain; snap-on type; white	www.wago.com/793-5501
	Item no.: 793-5501/000-002 WMB marking card; as card; for terminal block width 5 - 17.5 mm; stretchable 5 - 5.2 mm; plain; snap-on type; yellow	www.wago.com/793-5501/000-002

Subject to changes. Please also observe the further product documentation!

	Item no.: 793-5501/000-005 WMB marking card; as card; for terminal block width 5 - 17.5 mm; stretchable 5 - 5.2 mm; plain; snap-on type; red	www.wago.com/793-5501/000-005
	Item no.: 793-5501/000-006 WMB marking card; as card; for terminal block width 5 - 17.5 mm; stretchable 5 - 5.2 mm; plain; snap-on type; blue	www.wago.com/793-5501/000-006
	Item no.: 793-5501/000-007 WMB marking card; as card; for terminal block width 5 - 17.5 mm; stretchable 5 - 5.2 mm; plain; snap-on type; gray	www.wago.com/793-5501/000-007
	Item no.: 793-5501/000-012 WMB marking card; as card; for terminal block width 5 - 17.5 mm; stretchable 5 - 5.2 mm; plain; snap-on type; orange	www.wago.com/793-5501/000-012
	Item no.: 793-5501/000-014 WMB marking card; as card; for terminal block width 5 - 17.5 mm; stretchable 5 - 5.2 mm; plain; snap-on type; brown	www.wago.com/793-5501/000-014
	Item no.: 793-5501/000-017 WMB marking card; as card; for terminal block width 5 - 17.5 mm; stretchable 5 - 5.2 mm; plain; snap-on type; green	www.wago.com/793-5501/000-017
	Item no.: 793-5501/000-023 WMB marking card; as card; for terminal block width 5 - 17.5 mm; stretchable 5 - 5.2 mm; plain; snap-on type; light green	www.wago.com/793-5501/000-023
	Item no.: 793-5501/000-024 WMB marking card; as card; for terminal block width 5 - 17.5 mm; stretchable 5 - 5.2 mm; plain; snap-on type; violet	www.wago.com/793-5501/000-024
	Item no.: 793-566 WMB marking card; as card; MARKED; 1 ... 50 (2x); not stretchable; Horizontal marking; snap-on type; white	www.wago.com/793-566
	Item no.: 793-566/000-002 WMB marking card; as card; MARKED; 1 ... 50 (2x); not stretchable; Horizontal marking; snap-on type; yellow	www.wago.com/793-566/000-002
	Item no.: 793-566/000-005 WMB marking card; as card; MARKED; 1 ... 50 (2x); not stretchable; Horizontal marking; snap-on type; red	www.wago.com/793-566/000-005
	Item no.: 793-566/000-006 WMB marking card; as card; MARKED; 1 ... 50 (2x); not stretchable; Horizontal marking; snap-on type; blue	www.wago.com/793-566/000-006
	Item no.: 793-566/000-007 WMB marking card; as card; MARKED; 1 ... 50 (2x); not stretchable; Horizontal marking; snap-on type; gray	www.wago.com/793-566/000-007

Subject to changes. Please also observe the further product documentation!

**Item no.: 793-566/000-012**

WMB marking card; as card; MARKED; 1 ... 50 (2x); not stretchable; Horizontal marking; snap-on type; orange

www.wago.com/793-566/000-012**Item no.: 793-566/000-017**

WMB marking card; as card; MARKED; 1 ... 50 (2x); not stretchable; Horizontal marking; snap-on type; light green

www.wago.com/793-566/000-017**Item no.: 793-566/000-023**

WMB marking card; as card; MARKED; 1 ... 50 (2x); not stretchable; Horizontal marking; snap-on type; green

www.wago.com/793-566/000-023**Item no.: 793-566/000-024**

WMB marking card; as card; MARKED; 1 ... 50 (2x); not stretchable; Horizontal marking; snap-on type; violet

www.wago.com/793-566/000-024**ferrule****Item no.: 216-241**Ferrule; Sleeve for 0.5 mm² / 20 AWG; insulated; electro-tin plated; electrolytic copper; gastight crimped; acc. to DIN 46228, Part 4/09.90; whitewww.wago.com/216-241**Item no.: 216-242**Ferrule; Sleeve for 0.75 mm² / 18 AWG; insulated; electro-tin plated; electrolytic copper; gastight crimped; acc. to DIN 46228, Part 4/09.90; graywww.wago.com/216-242**Item no.: 216-243**Ferrule; Sleeve for 1 mm² / AWG 18; insulated; electro-tin plated; electrolytic copper; gastight crimped; acc. to DIN 46228, Part 4/09.90; redwww.wago.com/216-243**Item no.: 216-244**Ferrule; Sleeve for 1.5 mm² / AWG 16; insulated; electro-tin plated; electrolytic copper; gastight crimped; acc. to DIN 46228, Part 4/09.90; blackwww.wago.com/216-244**tools****Item no.: 210-719**

Operating tool; Blade: 2.5 x 0.4 mm; with a partially insulated shaft

www.wago.com/210-719**Downloads****Documentation****Bid Text**

858-508 GAEB X81 - Datei	Feb 19, 2019	xml 4.8 kB	Download
-----------------------------	--------------	---------------	----------

858-508 GAEB docx - Datei	Feb 20, 2019	docx 17.4 kB	Download
------------------------------	--------------	-----------------	----------

Instruction Leaflet

Stecksockel für Elementarrelais		pdf 2.6 MB	Download
---------------------------------	--	---------------	----------

Subject to changes. Please also observe the further product documentation!

Additional Information

Disposal; Electrical and electronic equipment, Packaging

V 1.0.0

pdf
265.8 kB

[Download](#)

CAD/CAE-Data

CAD data

2D/3D Models 858-508

[URL](#)

[Download](#)

CAE data

EPLAN Data Portal 858-508

[URL](#)

[Download](#)

WSCAD Universe 858-508

[URL](#)

[Download](#)

Installation Notes

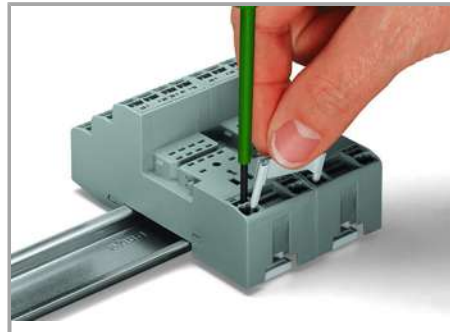
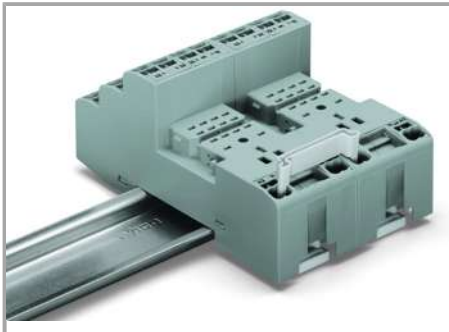

Remove jumper with screwdriver.

Marking

Subject to changes. Please also observe the further product documentation!

WAGO Kontakttechnik GmbH & Co. KG
Hansastr. 27
32423 Minden
Phone: +49571 887-0 | Fax: +49571 887-169
Email: info.de@wago.com | Web: www.wago.com

Do you have any questions about our products?
We are always happy to take your call at +49 (571) 887-44222.

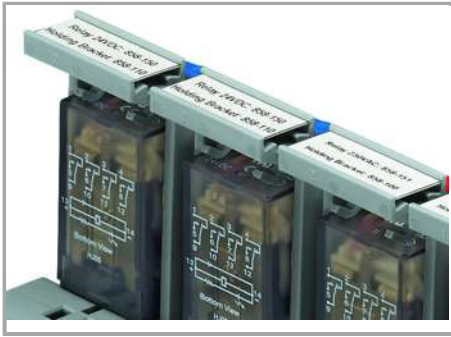

Marking using WMB Multi markers and group marker carriers

Subject to changes. Please also observe the further product documentation!