

Data sheet | Item number: 859-712

Optocoupler module; gray

[www.wago.com/859-712](http://www.wago.com/859-712)

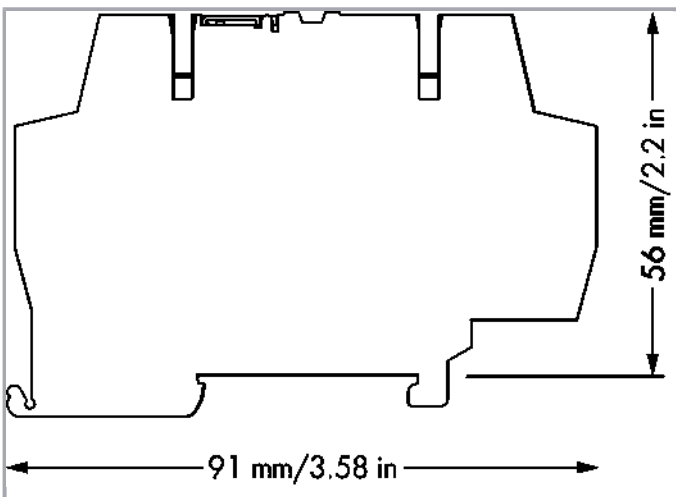
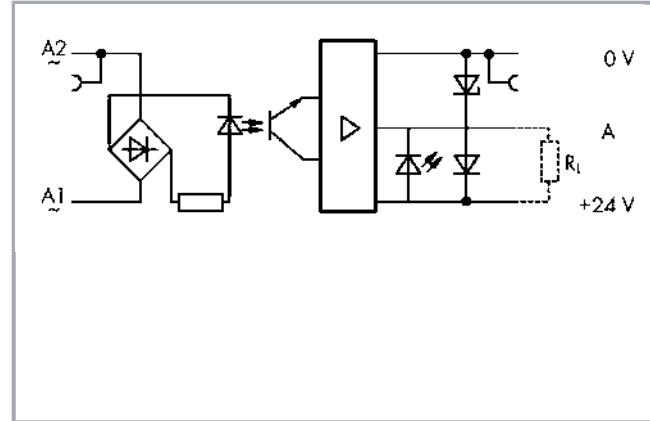
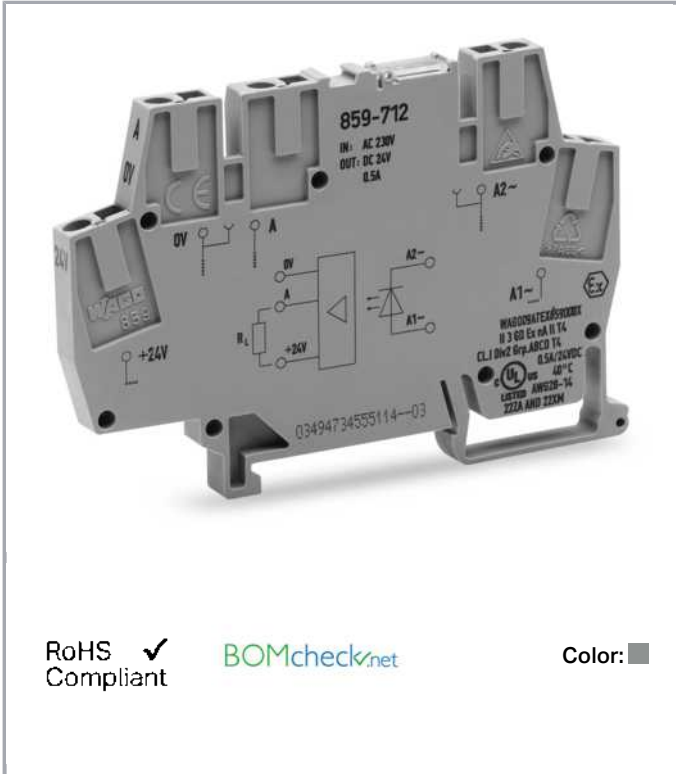

### Item description

Subject to changes. Please also observe the further product documentation!

WAGO Kontakttechnik GmbH & Co. KG  
Hansastr. 27  
32423 Minden  
Phone: +49571 887-0 | Fax: +49571 887-169  
Email: [info.de@wago.com](mailto:info.de@wago.com) | Web: [www.wago.com](http://www.wago.com)

Do you have any questions about our products?  
We are always happy to take your call at +49 (571) 887-44222.

**Note:**

Optocouplers and solid state relays are designed for use in signal processing networks, which are not supplied by the low-voltage power supply networks.

**Data****Technical Data****Control circuit**

|                                  |                  |
|----------------------------------|------------------|
| Nominal input voltage $U_N$      | AC 230 V         |
| Input voltage range (low level)  | AC 0 ... 90 V    |
| Input voltage range (high level) | AC 175 ... 270 V |
| Nominal input current at $U_N$   | 0,6 mA           |

**Load circuit:**

|                                    |   |
|------------------------------------|---|
| Circuit type                       | 3-conductor termination<br>Low-side switching |
| Limiting continuous current        | 0,5 A   |
| Nominal output voltage             | DC 24 V                                       |
| Output voltage range               | DC 20 ... 30 V                                |
| Max. voltage drop at output        | ≤ DC 1,2 V                                    |
| Leakage current at nominal voltage | ≤ 10 μA                                       |
| Max. output (reverse current)      | 11 mA   |
| Turn-on time                       | ≤ 30 ms                                       |
| Drop-out time                      | ≤ 30 ms                                       |

**Signaling**

|                   |         |
|-------------------|---------|
| Status indication | LED red |
|-------------------|---------|

**Safety and protection:**

|   |           |
|---|-----------|
| Dielectric strength, control/load circuit (AC, 1 min) | 2,5 kVrms |
|---|-----------|

**Connection data**

|                         |  |
|-------------------------|--|
| Connection technology   | CAGE CLAMP®                                  |
| Solid conductor         | 0,08 ... 2,5 mm <sup>2</sup> / 28 ... 14 AWG |
| Fine-stranded conductor | 0,08 ... 2,5 mm <sup>2</sup> / 28 ... 14 AWG |

Subject to changes. Please also observe the further product documentation!



|              |                                |
|--------------|--------------------------------|
| Strip length | 5 ... 6 mm / 0.2 ... 0.24 inch |
|--------------|--------------------------------|

### Geometrical Data

|                                       |                    |
|---------------------------------------|--------------------|
| Width                                 | 6 mm / 0.236 inch  |
| Height from upper-edge of DIN-35 rail | 56 mm / 2.205 inch |
| Depth                                 | 91 mm / 3.583 inch |

### Mechanical data

|                  |             |
|------------------|-------------|
| Type of mounting | DIN-35 rail |
|------------------|-------------|

### Material Data

|           |          |
|-----------|----------|
| Color     | gray     |
| Fire load | 0.313 MJ |
| Weight    | 20.4 g   |

### Environmental Requirements

|  |                |
|--|----------------|
| Surrounding air (operating) temperature at $U_N$ | -25 ... 55 °C  |
| Surrounding air (storage) temperature            | -40 ... 70 °C  |
| Processing temperature                           | -25 ... +50 °C |

### Standards and specifications

|                          |  |
|--------------------------|--|
| Standards/specifications | EN 60664-1; EN 61000-6-2; EN 61000-6-3; EN 61373; UL 508 |
|--------------------------|--|

### Commercial data

|                    |                           |
|--------------------|---------------------------|
| Product Group      | 6 (Interface Electronics) |
| Packaging type     | BOX                       |
| Country of origin  | DE                        |
| GTIN               | 4055143604734             |
| Customs Tariff No. | 85365005000               |

### Approvals / Certificates

#### UL-Approvals

| Logo | Approval                                     | Additional Approval Text | Certificate name |
|------|--|--------------------------|------------------|
|      | <b>UL</b>                                    | UL 508                   | E175199          |
|      | UL International Netherlands B.V. (ORDINARY) |                          | Sec.4            |

Subject to changes. Please also observe the further product documentation!











LOCATIONS)

## Counterpart

## Compatible products















### Jumper

|  |   |  |
|--|---|--|
|    | <b>Item no.: 859-402</b><br>Push-in type jumper bar; 2-way; Nominal current 18 A; insulated; light gray     | <a href="http://www.wago.com/859-402">www.wago.com/859-402</a>                 |
|    | <b>Item no.: 859-402/000-005</b><br>Push-in type jumper bar; 2-way; Nominal current 18 A; insulated; red    | <a href="http://www.wago.com/859-402/000-005">www.wago.com/859-402/000-005</a> |
|  | <b>Item no.: 859-402/000-006</b><br>Push-in type jumper bar; 2-way; Nominal current 18 A; insulated; blue   | <a href="http://www.wago.com/859-402/000-006">www.wago.com/859-402/000-006</a> |
|  | <b>Item no.: 859-402/000-029</b><br>Push-in type jumper bar; 2-way; Nominal current 18 A; insulated; yellow | <a href="http://www.wago.com/859-402/000-029">www.wago.com/859-402/000-029</a> |
|  | <b>Item no.: 859-403</b><br>Push-in type jumper bar; 3-way; Nominal current 18 A; insulated; light gray     | <a href="http://www.wago.com/859-403">www.wago.com/859-403</a>                 |
|  | <b>Item no.: 859-403/000-005</b><br>Push-in type jumper bar; 3-way; Nominal current 18 A; insulated; red    | <a href="http://www.wago.com/859-403/000-005">www.wago.com/859-403/000-005</a> |
|  | <b>Item no.: 859-403/000-006</b><br>Push-in type jumper bar; 3-way; Nominal current 18 A; insulated; blue   | <a href="http://www.wago.com/859-403/000-006">www.wago.com/859-403/000-006</a> |
|  | <b>Item no.: 859-403/000-029</b><br>Push-in type jumper bar; 3-way; Nominal current 18 A; insulated; yellow | <a href="http://www.wago.com/859-403/000-029">www.wago.com/859-403/000-029</a> |
|  | <b>Item no.: 859-404</b><br>Push-in type jumper bar; 4-way; Nominal current 18 A; insulated; light gray     | <a href="http://www.wago.com/859-404">www.wago.com/859-404</a>                 |















Subject to changes. Please also observe the further product documentation!

WAGO Kontakttechnik GmbH & Co. KG  
Hansastr. 27  
32423 Minden  
Phone: +49571 887-0 | Fax: +49571 887-169  
Email: [info.de@wago.com](mailto:info.de@wago.com) | Web: [www.wago.com](http://www.wago.com)

Do you have any questions about our products?  
We are always happy to take your call at +49 (571) 887-44222.















|  |   |  |
|--|---|--|
|    | <b>Item no.: 859-404/000-005</b><br>Push-in type jumper bar; 4-way; Nominal current 18 A; insulated; red    | <a href="http://www.wago.com/859-404/000-005">www.wago.com/859-404/000-005</a> |
|    | <b>Item no.: 859-404/000-006</b><br>Push-in type jumper bar; 4-way; Nominal current 18 A; insulated; blue   | <a href="http://www.wago.com/859-404/000-006">www.wago.com/859-404/000-006</a> |
|    | <b>Item no.: 859-404/000-029</b><br>Push-in type jumper bar; 4-way; Nominal current 18 A; insulated; yellow | <a href="http://www.wago.com/859-404/000-029">www.wago.com/859-404/000-029</a> |
|    | <b>Item no.: 859-405</b><br>Push-in type jumper bar; 5-way; Nominal current 18 A; insulated; light gray     | <a href="http://www.wago.com/859-405">www.wago.com/859-405</a>                 |
|    | <b>Item no.: 859-405/000-005</b><br>Push-in type jumper bar; 5-way; Nominal current 18 A; insulated; red    | <a href="http://www.wago.com/859-405/000-005">www.wago.com/859-405/000-005</a> |
|    | <b>Item no.: 859-405/000-006</b><br>Push-in type jumper bar; 5-way; Nominal current 18 A; insulated; blue   | <a href="http://www.wago.com/859-405/000-006">www.wago.com/859-405/000-006</a> |
|    | <b>Item no.: 859-405/000-029</b><br>Push-in type jumper bar; 5-way; Nominal current 18 A; insulated; yellow | <a href="http://www.wago.com/859-405/000-029">www.wago.com/859-405/000-029</a> |
|   | <b>Item no.: 859-406</b><br>Push-in type jumper bar; 6-way; Nominal current 18 A; insulated; light gray     | <a href="http://www.wago.com/859-406">www.wago.com/859-406</a>                 |
|  | <b>Item no.: 859-406/000-005</b><br>Push-in type jumper bar; 6-way; Nominal current 18 A; insulated; red    | <a href="http://www.wago.com/859-406/000-005">www.wago.com/859-406/000-005</a> |
|  | <b>Item no.: 859-406/000-006</b><br>Push-in type jumper bar; 6-way; Nominal current 18 A; insulated; blue   | <a href="http://www.wago.com/859-406/000-006">www.wago.com/859-406/000-006</a> |
|  | <b>Item no.: 859-406/000-029</b><br>Push-in type jumper bar; 6-way; Nominal current 18 A; insulated; yellow | <a href="http://www.wago.com/859-406/000-029">www.wago.com/859-406/000-029</a> |
|  | <b>Item no.: 859-407</b><br>Push-in type jumper bar; 7-way; Nominal current 18 A; insulated; light gray     | <a href="http://www.wago.com/859-407">www.wago.com/859-407</a>                 |
|  | <b>Item no.: 859-407/000-005</b><br>Push-in type jumper bar; 7-way; Nominal current 18 A; insulated; red    | <a href="http://www.wago.com/859-407/000-005">www.wago.com/859-407/000-005</a> |
|  | <b>Item no.: 859-407/000-006</b><br>Push-in type jumper bar; 7-way; Nominal current 18 A; insulated; blue   | <a href="http://www.wago.com/859-407/000-006">www.wago.com/859-407/000-006</a> |

Subject to changes. Please also observe the further product documentation!















|  |  |  |
|--|--|--|
|    | <b>Item no.: 859-407/000-029</b><br>Push-in type jumper bar; 7-way; Nominal current 18 A; insulated; yellow  | <a href="http://www.wago.com/859-407/000-029">www.wago.com/859-407/000-029</a> |
|    | <b>Item no.: 859-408</b><br>Push-in type jumper bar; 8-way; Nominal current 18 A; insulated; light gray      | <a href="http://www.wago.com/859-408">www.wago.com/859-408</a>                 |
|    | <b>Item no.: 859-408/000-005</b><br>Push-in type jumper bar; 8-way; Nominal current 18 A; insulated; red     | <a href="http://www.wago.com/859-408/000-005">www.wago.com/859-408/000-005</a> |
|    | <b>Item no.: 859-408/000-006</b><br>Push-in type jumper bar; 8-way; Nominal current 18 A; insulated; blue    | <a href="http://www.wago.com/859-408/000-006">www.wago.com/859-408/000-006</a> |
|    | <b>Item no.: 859-408/000-029</b><br>Push-in type jumper bar; 8-way; Nominal current 18 A; insulated; yellow  | <a href="http://www.wago.com/859-408/000-029">www.wago.com/859-408/000-029</a> |
|    | <b>Item no.: 859-409</b><br>Push-in type jumper bar; 9-way; Nominal current 18 A; insulated; light gray      | <a href="http://www.wago.com/859-409">www.wago.com/859-409</a>                 |
|    | <b>Item no.: 859-409/000-005</b><br>Push-in type jumper bar; 9-way; Nominal current 18 A; insulated; red     | <a href="http://www.wago.com/859-409/000-005">www.wago.com/859-409/000-005</a> |
|   | <b>Item no.: 859-409/000-006</b><br>Push-in type jumper bar; 9-way; Nominal current 18 A; insulated; blue    | <a href="http://www.wago.com/859-409/000-006">www.wago.com/859-409/000-006</a> |
|  | <b>Item no.: 859-409/000-029</b><br>Push-in type jumper bar; 9-way; Nominal current 18 A; insulated; yellow  | <a href="http://www.wago.com/859-409/000-029">www.wago.com/859-409/000-029</a> |
|  | <b>Item no.: 859-410</b><br>Push-in type jumper bar; 10-way; Nominal current 18 A; insulated; light gray     | <a href="http://www.wago.com/859-410">www.wago.com/859-410</a>                 |
|  | <b>Item no.: 859-410/000-005</b><br>Push-in type jumper bar; 10-way; Nominal current 18 A; insulated; red    | <a href="http://www.wago.com/859-410/000-005">www.wago.com/859-410/000-005</a> |
|  | <b>Item no.: 859-410/000-006</b><br>Push-in type jumper bar; 10-way; Nominal current 18 A; insulated; blue   | <a href="http://www.wago.com/859-410/000-006">www.wago.com/859-410/000-006</a> |
|  | <b>Item no.: 859-410/000-029</b><br>Push-in type jumper bar; 10-way; Nominal current 18 A; insulated; yellow | <a href="http://www.wago.com/859-410/000-029">www.wago.com/859-410/000-029</a> |
| <b>tools</b>   |  |  |
|  | <b>Item no.: 210-720</b><br>Operating tool; Blade: 3.5 x 0.5 mm; with a partially insulated shaft            | <a href="http://www.wago.com/210-720">www.wago.com/210-720</a>                 |

Subject to changes. Please also observe the further product documentation!

## Marking accessories

|  |   |  |
|--|---|--|
|    | <b>Item no.: 2009-145</b><br>Mini-WSB Inline; for Smart Printer; 1700 pieces on roll; stretchable 5 - 5.2 mm; plain; snap-on type; white          | <a href="http://www.wago.com/2009-145">www.wago.com/2009-145</a>                 |
|    | <b>Item no.: 2009-145/000-002</b><br>Mini-WSB Inline; for Smart Printer; 1700 pieces on roll; stretchable 5 - 5.2 mm; plain; snap-on type; yellow | <a href="http://www.wago.com/2009-145/000-002">www.wago.com/2009-145/000-002</a> |
|    | <b>Item no.: 2009-145/000-005</b><br>Mini-WSB Inline; for Smart Printer; 1700 pieces on roll; stretchable 5 - 5.2 mm; plain; snap-on type; red    | <a href="http://www.wago.com/2009-145/000-005">www.wago.com/2009-145/000-005</a> |
|    | <b>Item no.: 2009-145/000-006</b><br>Mini-WSB Inline; for Smart Printer; 1700 pieces on roll; stretchable 5 - 5.2 mm; plain; snap-on type; blue   | <a href="http://www.wago.com/2009-145/000-006">www.wago.com/2009-145/000-006</a> |
|    | <b>Item no.: 2009-145/000-007</b><br>Mini-WSB Inline; for Smart Printer; 1700 pieces on roll; stretchable 5 - 5.2 mm; plain; snap-on type; gray   | <a href="http://www.wago.com/2009-145/000-007">www.wago.com/2009-145/000-007</a> |
|    | <b>Item no.: 2009-145/000-012</b><br>Mini-WSB Inline; for Smart Printer; 1700 pieces on roll; stretchable 5 - 5.2 mm; plain; snap-on type; orange | <a href="http://www.wago.com/2009-145/000-012">www.wago.com/2009-145/000-012</a> |
|   | <b>Item no.: 2009-145/000-023</b><br>Mini-WSB Inline; for Smart Printer; 1700 pieces on roll; stretchable 5 - 5.2 mm; plain; snap-on type; green  | <a href="http://www.wago.com/2009-145/000-023">www.wago.com/2009-145/000-023</a> |
|  | <b>Item no.: 2009-145/000-024</b><br>Mini-WSB Inline; for Smart Printer; 1700 pieces on roll; stretchable 5 - 5.2 mm; plain; snap-on type; violet | <a href="http://www.wago.com/2009-145/000-024">www.wago.com/2009-145/000-024</a> |
|  | <b>Item no.: 210-110</b><br>Fiber-tip pen   | <a href="http://www.wago.com/210-110">www.wago.com/210-110</a>                   |
|  | <b>Item no.: 248-501</b><br>Miniature WSB Quick marking system; plain; Marker width 5 mm; 10 strips with 10 markers per card                      | <a href="http://www.wago.com/248-501">www.wago.com/248-501</a>                   |
|  | <b>Item no.: 248-501/000-002</b><br>Mini-WSB marking card; as card; not stretchable; plain; snap-on type; yellow                                  | <a href="http://www.wago.com/248-501/000-002">www.wago.com/248-501/000-002</a>   |
|  | <b>Item no.: 248-501/000-005</b><br>Mini-WSB marking card; as card; not stretchable; plain; snap-on type; red                                     | <a href="http://www.wago.com/248-501/000-005">www.wago.com/248-501/000-005</a>   |
|  | <b>Item no.: 248-501/000-006</b><br>Mini-WSB marking card; as card; not stretchable; plain; snap-on type; blue                                    | <a href="http://www.wago.com/248-501/000-006">www.wago.com/248-501/000-006</a>   |
|  | <b>Item no.: 248-501/000-007</b><br>Mini-WSB marking card; as card; not stretchable; plain; snap-on type; gray                                    | <a href="http://www.wago.com/248-501/000-007">www.wago.com/248-501/000-007</a>   |

Subject to changes. Please also observe the further product documentation!

|  |  |  |
|--|--|--|
|    | <b>Item no.: 248-501/000-012</b><br>Mini-WSB marking card; as card; not stretchable; plain; snap-on type; orange                                       | <a href="http://www.wago.com/248-501/000-012">www.wago.com/248-501/000-012</a> |
|    | <b>Item no.: 248-501/000-017</b><br>Mini-WSB marking card; as card; not stretchable; plain; snap-on type; light green                                  | <a href="http://www.wago.com/248-501/000-017">www.wago.com/248-501/000-017</a> |
|    | <b>Item no.: 248-501/000-023</b><br>Mini-WSB marking card; as card; not stretchable; plain; snap-on type; green  | <a href="http://www.wago.com/248-501/000-023">www.wago.com/248-501/000-023</a> |
|    | <b>Item no.: 248-501/000-024</b><br>Mini-WSB marking card; as card; not stretchable; plain; snap-on type; violet                                       | <a href="http://www.wago.com/248-501/000-024">www.wago.com/248-501/000-024</a> |
|    | <b>Item no.: 248-502</b><br>Mini-WSB marking card; as card; MARKED; 1 ... 10 (10x); not stretchable; Horizontal marking; snap-on type; white           | <a href="http://www.wago.com/248-502">www.wago.com/248-502</a>                 |
|    | <b>Item no.: 248-502/000-024</b><br>Mini-WSB marking card; as card; MARKED; 1 ... 10 (10x); not stretchable; Horizontal marking; snap-on type; violet  | <a href="http://www.wago.com/248-502/000-024">www.wago.com/248-502/000-024</a> |
|   | <b>Item no.: 248-503</b><br>Mini-WSB marking card; as card; MARKED; 11 ... 20 (10x); not stretchable; Horizontal marking; snap-on type; white          | <a href="http://www.wago.com/248-503">www.wago.com/248-503</a>                 |
|  | <b>Item no.: 248-503/000-024</b><br>Mini-WSB marking card; as card; MARKED; 11 ... 20 (10x); not stretchable; Horizontal marking; snap-on type; violet | <a href="http://www.wago.com/248-503/000-024">www.wago.com/248-503/000-024</a> |
|  | <b>Item no.: 248-504</b><br>Mini-WSB marking card; as card; MARKED; 21 ... 30 (10x); not stretchable; Horizontal marking; snap-on type; white          | <a href="http://www.wago.com/248-504">www.wago.com/248-504</a>                 |
|  | <b>Item no.: 248-504/000-024</b><br>Mini-WSB marking card; as card; MARKED; 21 ... 30 (10x); not stretchable; Horizontal marking; snap-on type; violet | <a href="http://www.wago.com/248-504/000-024">www.wago.com/248-504/000-024</a> |
|  | <b>Item no.: 248-505/000-024</b><br>Mini-WSB marking card; as card; MARKED; 31 ... 40 (10x); not stretchable; Horizontal marking; snap-on type; violet | <a href="http://www.wago.com/248-505/000-024">www.wago.com/248-505/000-024</a> |
|  | <b>Item no.: 248-506</b><br>Mini-WSB marking card; as card; MARKED; 41 ... 50 (10x); not stretchable; Horizontal marking; snap-on type; white          | <a href="http://www.wago.com/248-506">www.wago.com/248-506</a>                 |
| <b>check</b>   |  |  |
|  | <b>Item no.: 859-500</b><br>Test pin; 1 mm Ø; with solder connection for test wire   | <a href="http://www.wago.com/859-500">www.wago.com/859-500</a>                 |
| <b>End plate</b>   |  |  |
|  | <b>Item no.: 859-525</b><br>End and intermediate plate; 1 mm thick; gray   | <a href="http://www.wago.com/859-525">www.wago.com/859-525</a>                 |

Subject to changes. Please also observe the further product documentation!



## ferrule

|   |  |  |
|---|--|--|
|  | <b>Item no.: 216-221</b><br>Ferrule; Sleeve for 0.5 mm <sup>2</sup> / 20 AWG; insulated; electro-tin plated; white   | <a href="http://www.wago.com/216-221">www.wago.com/216-221</a> |
|  | <b>Item no.: 216-222</b><br>Ferrule; Sleeve for 0.75 mm <sup>2</sup> / 18 AWG; insulated; electro-tin plated; gray   | <a href="http://www.wago.com/216-222">www.wago.com/216-222</a> |
|  | <b>Item no.: 216-223</b><br>Ferrule; Sleeve for 1 mm <sup>2</sup> / AWG 18; insulated; electro-tin plated; red       | <a href="http://www.wago.com/216-223">www.wago.com/216-223</a> |
|  | <b>Item no.: 216-224</b><br>Ferrule; Sleeve for 1.5 mm <sup>2</sup> / AWG 16; insulated; electro-tin plated; black   | <a href="http://www.wago.com/216-224">www.wago.com/216-224</a> |
|   | <b>Item no.: 216-321</b><br>Ferrule; Sleeve for 0.25 mm <sup>2</sup> / AWG 24; insulated; electro-tin plated; yellow | <a href="http://www.wago.com/216-321">www.wago.com/216-321</a> |
|  | <b>Item no.: 216-322</b><br>Ferrule; Sleeve for 0.34 mm <sup>2</sup> / 22 AWG; insulated; electro-tin plated; green  | <a href="http://www.wago.com/216-322">www.wago.com/216-322</a> |

## Downloads

## Documentation

## Bid Text

|                              |              |                 |          |
|------------------------------|--------------|-----------------|----------|
| 859-712<br>GAEB X81 - Datei  | Feb 19, 2019 | xml<br>3.8 kB   | Download |
| 859-712<br>GAEB docx - Datei | Feb 20, 2019 | docx<br>15.7 kB | Download |

## Instruction Leaflet

|                                    |                         |               |          |
|------------------------------------|-------------------------|---------------|----------|
| Relay modules, Optocoupler modules | V 1.2.0<br>Aug 30, 2019 | pdf<br>2.2 MB | Download |
|------------------------------------|-------------------------|---------------|----------|

## Additional Information

|  |         |                 |          |
|--|---------|-----------------|----------|
| Disposal; Electrical and electronic equipment, Packaging | V 1.0.0 | pdf<br>265.8 kB | Download |
|--|---------|-----------------|----------|

## CAD/CAE-Data

## CAD data

|                      |     |          |
|----------------------|-----|----------|
| 2D/3D Models 859-712 | URL | Download |
|----------------------|-----|----------|

## CAE data

Subject to changes. Please also observe the further product documentation!

EPLAN Data Portal 859-712

URL

Download

WSCAD Universe 859-712

URL

Download

## Installation Notes

### Inserting a conductor

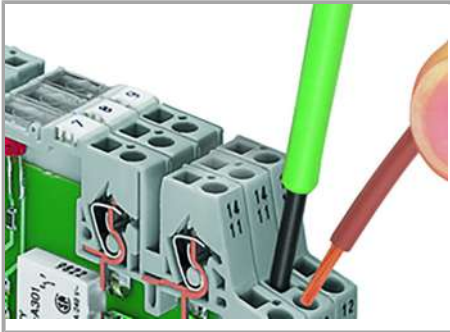

Connection of conductor

### Jumpered

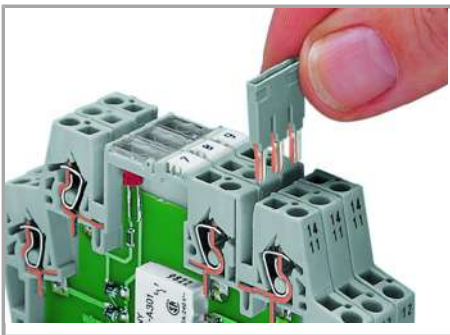

Easy commoning using adjacent jumpers

### Marking

Subject to changes. Please also observe the further product documentation!



Marking using miniature WSB quick marking card

Subject to changes. Please also observe the further product documentation!