

Data sheet | Item number: 859-753

Solid-state relay module; Nominal input voltage: 5 VDC

[www.wago.com/859-753](http://www.wago.com/859-753)

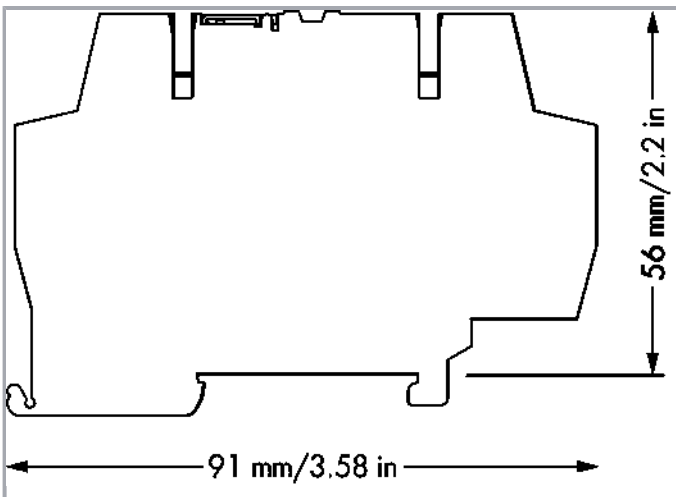
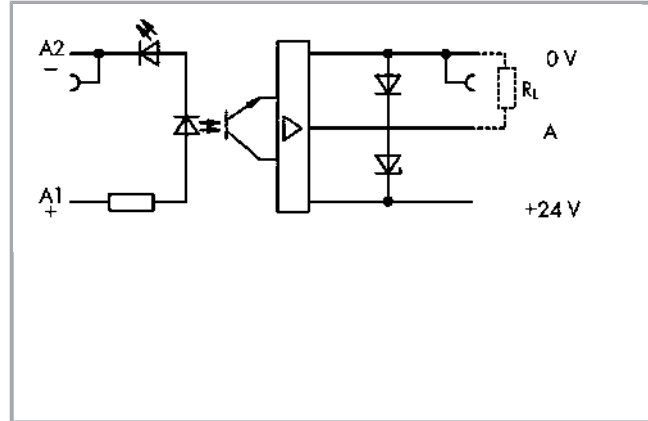
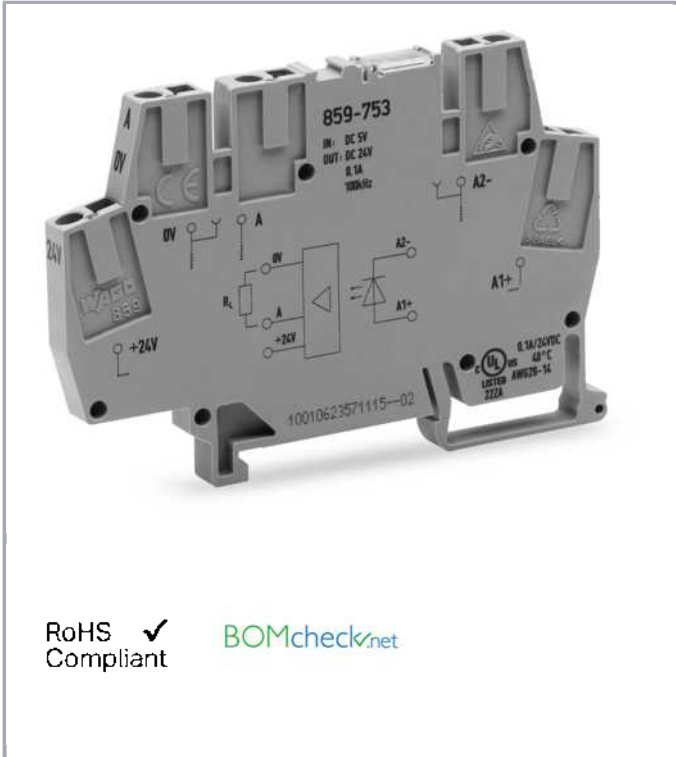

Item description

Subject to changes. Please also observe the further product documentation!

WAGO Kontakttechnik GmbH & Co. KG  
Hansastr. 27  
32423 Minden  
Phone: +49571 887-0 | Fax: +49571 887-169  
Email: [info.de@wago.com](mailto:info.de@wago.com) | Web: [www.wago.com](http://www.wago.com)

Do you have any questions about our products?  
We are always happy to take your call at +49 (571) 887-44222.

**Note:**

Optocouplers and solid state relays are designed for use in signal processing networks, which are not supplied by the low-voltage power supply networks.

**Data****Technical Data****Control circuit**

Nominal input voltage $U_N$	DC 5 V
Input voltage range (low level)	DC 0 ... 1 V
Input voltage range (high level)	DC 4 ... 6,25 V
Nominal input current at $U_N$	16,5 mA

**Load circuit:**

Circuit type	3-wire connection High-side switching
Limiting continuous current	0,1 A
Peak output current	0.8 A
Nominal output voltage	DC 24 V
Output voltage range	DC 20 ... 28,8 V
Max. voltage drop at output	$\leq$ DC 1,2 V
Leakage current at nominal voltage	$\leq$ 10 $\mu$ A
Max. output (reverse current)	7 mA
Turn-on time	$\leq$ 0,5 $\mu$ s
Drop-out time	$\leq$ 5 $\mu$ s
Switching frequency	$\leq$ 100 kHz

**Signaling**

Status indication	Red LED
-------------------	---------

**Safety and protection:**

Rated voltage	300 V
Overvoltage category	II
Pollution degree	2
Dielectric strength, control/load circuit (AC, 1 min)	2,5 kVrms

Subject to changes. Please also observe the further product documentation!



Insulation type (control/load circuit)	Basic insulation
Insulation type (adjacent devices)	Reinforced insulation (safe isolation)

### Connection data

Connection technology	CAGE CLAMP®
Solid conductor	0,08 ... 2,5 mm <sup>2</sup> / 28 ... 14 AWG
Fine-stranded conductor	0,08 ... 2,5 mm <sup>2</sup> / 28 ... 14 AWG
Strip length	5 ... 6 mm / 0.2 ... 0.24 inch

### Geometrical Data

Width	6 mm / 0.236 inch
Height from upper-edge of DIN-35 rail	56 mm / 2.205 inch
Depth	91 mm / 3.583 inch

### Mechanical data

Type of mounting	DIN-35 rail
------------------	-------------

### Material Data

Fire load	0.313 MJ
Weight	15.6 g

### Environmental Requirements

Surrounding air (operating) temperature at U <sub>N</sub>	-25 ... 55 °C
Surrounding air (storage) temperature	-40 ... 70 °C
Processing temperature	-25 ... +50 °C

### Standards and specifications

Standards/specifications	EN 60664-1; EN 61000-6-2; EN 61000-6-3; EN 61373; UL 508
--------------------------	--

### Commercial data

Product Group	6 (Interface Electronics)
Packaging type	BOX
Country of origin	DE
GTIN	4055143605472
Customs Tariff No.	85364900990

Subject to changes. Please also observe the further product documentation!

WAGO Kontakttechnik GmbH & Co. KG  
 Hansastr. 27  
 32423 Minden  
 Phone: +49571 887-0 | Fax: +49571 887-169  
 Email: [info.de@wago.com](mailto:info.de@wago.com) | Web: [www.wago.com](http://www.wago.com)

Do you have any questions about our products?  
 We are always happy to take your call at +49 (571) 887-44222.

## Approvals / Certificates

### UL-Approvals

Logo	Approval	Additional Approval Text	Certificate name
	<b>UL</b> UL International Netherlands B.V. (ORDINARY LOCATIONS)	UL 508	E175199 Sec.4

### Counterpart

### Compatible products

#### End plate



**Item no.: 859-525**

End and intermediate plate; 1 mm thick; gray

[www.wago.com/859-525](http://www.wago.com/859-525)

#### Marking accessories



**Item no.: 2009-145**

Mini-WSB Inline; for Smart Printer; 1700 pieces on roll; stretchable 5 - 5.2 mm; plain; snap-on type; white

[www.wago.com/2009-145](http://www.wago.com/2009-145)



**Item no.: 2009-145/000-002**

Mini-WSB Inline; for Smart Printer; 1700 pieces on roll; stretchable 5 - 5.2 mm; plain; snap-on type; yellow

[www.wago.com/2009-145/000-002](http://www.wago.com/2009-145/000-002)



**Item no.: 2009-145/000-005**

Mini-WSB Inline; for Smart Printer; 1700 pieces on roll; stretchable 5 - 5.2 mm; plain; snap-on type; red

[www.wago.com/2009-145/000-005](http://www.wago.com/2009-145/000-005)



**Item no.: 2009-145/000-006**

Mini-WSB Inline; for Smart Printer; 1700 pieces on roll; stretchable 5 - 5.2 mm; plain; snap-on type; blue

[www.wago.com/2009-145/000-006](http://www.wago.com/2009-145/000-006)



**Item no.: 2009-145/000-007**

Mini-WSB Inline; for Smart Printer; 1700 pieces on roll; stretchable 5 - 5.2 mm; plain; snap-on type; gray

[www.wago.com/2009-145/000-007](http://www.wago.com/2009-145/000-007)



**Item no.: 2009-145/000-012**

Mini-WSB Inline; for Smart Printer; 1700 pieces on roll; stretchable 5 - 5.2 mm; plain; snap-on type; orange

[www.wago.com/2009-145/000-012](http://www.wago.com/2009-145/000-012)

Subject to changes. Please also observe the further product documentation!

WAGO Kontakttechnik GmbH & Co. KG

Hansastr. 27















32423 Minden

Phone: +49571 887-0 | Fax: +49571 887-169















Email: [info.de@wago.com](mailto:info.de@wago.com) | Web: [www.wago.com](http://www.wago.com)

Do you have any questions about our products?















We are always happy to take your call at +49 (571) 887-44222.

	<b>Item no.: 2009-145/000-023</b> Mini-WSB Inline; for Smart Printer; 1700 pieces on roll; stretchable 5 - 5.2 mm; plain; snap-on type; green	<a href="http://www.wago.com/2009-145/000-023">www.wago.com/2009-145/000-023</a>
	<b>Item no.: 2009-145/000-024</b> Mini-WSB Inline; for Smart Printer; 1700 pieces on roll; stretchable 5 - 5.2 mm; plain; snap-on type; violet	<a href="http://www.wago.com/2009-145/000-024">www.wago.com/2009-145/000-024</a>
	<b>Item no.: 210-110</b> Fiber-tip pen	<a href="http://www.wago.com/210-110">www.wago.com/210-110</a>
	<b>Item no.: 248-501</b> Miniature WSB Quick marking system; plain; Marker width 5 mm; 10 strips with 10 markers per card	<a href="http://www.wago.com/248-501">www.wago.com/248-501</a>
	<b>Item no.: 248-501/000-002</b> Mini-WSB marking card; as card; not stretchable; plain; snap-on type; yellow	<a href="http://www.wago.com/248-501/000-002">www.wago.com/248-501/000-002</a>
	<b>Item no.: 248-501/000-005</b> Mini-WSB marking card; as card; not stretchable; plain; snap-on type; red	<a href="http://www.wago.com/248-501/000-005">www.wago.com/248-501/000-005</a>
	<b>Item no.: 248-501/000-006</b> Mini-WSB marking card; as card; not stretchable; plain; snap-on type; blue	<a href="http://www.wago.com/248-501/000-006">www.wago.com/248-501/000-006</a>
	<b>Item no.: 248-501/000-007</b> Mini-WSB marking card; as card; not stretchable; plain; snap-on type; gray	<a href="http://www.wago.com/248-501/000-007">www.wago.com/248-501/000-007</a>
	<b>Item no.: 248-501/000-012</b> Mini-WSB marking card; as card; not stretchable; plain; snap-on type; orange	<a href="http://www.wago.com/248-501/000-012">www.wago.com/248-501/000-012</a>
	<b>Item no.: 248-501/000-017</b> Mini-WSB marking card; as card; not stretchable; plain; snap-on type; light green	<a href="http://www.wago.com/248-501/000-017">www.wago.com/248-501/000-017</a>
	<b>Item no.: 248-501/000-023</b> Mini-WSB marking card; as card; not stretchable; plain; snap-on type; green	<a href="http://www.wago.com/248-501/000-023">www.wago.com/248-501/000-023</a>
	<b>Item no.: 248-501/000-024</b> Mini-WSB marking card; as card; not stretchable; plain; snap-on type; violet	<a href="http://www.wago.com/248-501/000-024">www.wago.com/248-501/000-024</a>
	<b>Item no.: 248-502</b> Mini-WSB marking card; as card; MARKED; 1 ... 10 (10x); not stretchable; Horizontal marking; snap-on type; white	<a href="http://www.wago.com/248-502">www.wago.com/248-502</a>
	<b>Item no.: 248-502/000-024</b> Mini-WSB marking card; as card; MARKED; 1 ... 10 (10x); not stretchable; Horizontal marking; snap-on type; violet	<a href="http://www.wago.com/248-502/000-024">www.wago.com/248-502/000-024</a>















Subject to changes. Please also observe the further product documentation!

	<b>Item no.: 248-503</b> Mini-WSB marking card; as card; MARKED; 11 ... 20 (10x); not stretchable; Horizontal marking; snap-on type; white	<a href="http://www.wago.com/248-503">www.wago.com/248-503</a>
	<b>Item no.: 248-503/000-024</b> Mini-WSB marking card; as card; MARKED; 11 ... 20 (10x); not stretchable; Horizontal marking; snap-on type; violet	<a href="http://www.wago.com/248-503/000-024">www.wago.com/248-503/000-024</a>
	<b>Item no.: 248-504</b> Mini-WSB marking card; as card; MARKED; 21 ... 30 (10x); not stretchable; Horizontal marking; snap-on type; white	<a href="http://www.wago.com/248-504">www.wago.com/248-504</a>
	<b>Item no.: 248-504/000-024</b> Mini-WSB marking card; as card; MARKED; 21 ... 30 (10x); not stretchable; Horizontal marking; snap-on type; violet	<a href="http://www.wago.com/248-504/000-024">www.wago.com/248-504/000-024</a>
	<b>Item no.: 248-505/000-024</b> Mini-WSB marking card; as card; MARKED; 31 ... 40 (10x); not stretchable; Horizontal marking; snap-on type; violet	<a href="http://www.wago.com/248-505/000-024">www.wago.com/248-505/000-024</a>
	<b>Item no.: 248-506</b> Mini-WSB marking card; as card; MARKED; 41 ... 50 (10x); not stretchable; Horizontal marking; snap-on type; white	<a href="http://www.wago.com/248-506">www.wago.com/248-506</a>
<b>Jumper</b>		
	<b>Item no.: 859-402</b> Push-in type jumper bar; 2-way; Nominal current 18 A; insulated; light gray	<a href="http://www.wago.com/859-402">www.wago.com/859-402</a>
	<b>Item no.: 859-402/000-005</b> Push-in type jumper bar; 2-way; Nominal current 18 A; insulated; red	<a href="http://www.wago.com/859-402/000-005">www.wago.com/859-402/000-005</a>
	<b>Item no.: 859-402/000-006</b> Push-in type jumper bar; 2-way; Nominal current 18 A; insulated; blue	<a href="http://www.wago.com/859-402/000-006">www.wago.com/859-402/000-006</a>
	<b>Item no.: 859-402/000-029</b> Push-in type jumper bar; 2-way; Nominal current 18 A; insulated; yellow	<a href="http://www.wago.com/859-402/000-029">www.wago.com/859-402/000-029</a>
	<b>Item no.: 859-403</b> Push-in type jumper bar; 3-way; Nominal current 18 A; insulated; light gray	<a href="http://www.wago.com/859-403">www.wago.com/859-403</a>
	<b>Item no.: 859-403/000-005</b> Push-in type jumper bar; 3-way; Nominal current 18 A; insulated; red	<a href="http://www.wago.com/859-403/000-005">www.wago.com/859-403/000-005</a>
	<b>Item no.: 859-403/000-006</b> Push-in type jumper bar; 3-way; Nominal current 18 A; insulated; blue	<a href="http://www.wago.com/859-403/000-006">www.wago.com/859-403/000-006</a>
	<b>Item no.: 859-403/000-029</b> Push-in type jumper bar; 3-way; Nominal current 18 A; insulated; yellow	<a href="http://www.wago.com/859-403/000-029">www.wago.com/859-403/000-029</a>

Subject to changes. Please also observe the further product documentation!

	<b>Item no.: 859-404</b> Push-in type jumper bar; 4-way; Nominal current 18 A; insulated; light gray	<a href="http://www.wago.com/859-404">www.wago.com/859-404</a>
	<b>Item no.: 859-404/000-005</b> Push-in type jumper bar; 4-way; Nominal current 18 A; insulated; red	<a href="http://www.wago.com/859-404/000-005">www.wago.com/859-404/000-005</a>
	<b>Item no.: 859-404/000-006</b> Push-in type jumper bar; 4-way; Nominal current 18 A; insulated; blue	<a href="http://www.wago.com/859-404/000-006">www.wago.com/859-404/000-006</a>
	<b>Item no.: 859-404/000-029</b> Push-in type jumper bar; 4-way; Nominal current 18 A; insulated; yellow	<a href="http://www.wago.com/859-404/000-029">www.wago.com/859-404/000-029</a>
	<b>Item no.: 859-405</b> Push-in type jumper bar; 5-way; Nominal current 18 A; insulated; light gray	<a href="http://www.wago.com/859-405">www.wago.com/859-405</a>
	<b>Item no.: 859-405/000-005</b> Push-in type jumper bar; 5-way; Nominal current 18 A; insulated; red	<a href="http://www.wago.com/859-405/000-005">www.wago.com/859-405/000-005</a>
	<b>Item no.: 859-405/000-006</b> Push-in type jumper bar; 5-way; Nominal current 18 A; insulated; blue	<a href="http://www.wago.com/859-405/000-006">www.wago.com/859-405/000-006</a>
	<b>Item no.: 859-405/000-029</b> Push-in type jumper bar; 5-way; Nominal current 18 A; insulated; yellow	<a href="http://www.wago.com/859-405/000-029">www.wago.com/859-405/000-029</a>
	<b>Item no.: 859-406</b> Push-in type jumper bar; 6-way; Nominal current 18 A; insulated; light gray	<a href="http://www.wago.com/859-406">www.wago.com/859-406</a>
	<b>Item no.: 859-406/000-005</b> Push-in type jumper bar; 6-way; Nominal current 18 A; insulated; red	<a href="http://www.wago.com/859-406/000-005">www.wago.com/859-406/000-005</a>
	<b>Item no.: 859-406/000-006</b> Push-in type jumper bar; 6-way; Nominal current 18 A; insulated; blue	<a href="http://www.wago.com/859-406/000-006">www.wago.com/859-406/000-006</a>
	<b>Item no.: 859-406/000-029</b> Push-in type jumper bar; 6-way; Nominal current 18 A; insulated; yellow	<a href="http://www.wago.com/859-406/000-029">www.wago.com/859-406/000-029</a>
	<b>Item no.: 859-407</b> Push-in type jumper bar; 7-way; Nominal current 18 A; insulated; light gray	<a href="http://www.wago.com/859-407">www.wago.com/859-407</a>
	<b>Item no.: 859-407/000-005</b> Push-in type jumper bar; 7-way; Nominal current 18 A; insulated; red	<a href="http://www.wago.com/859-407/000-005">www.wago.com/859-407/000-005</a>







Subject to changes. Please also observe the further product documentation!

	<b>Item no.: 859-407/000-006</b> Push-in type jumper bar; 7-way; Nominal current 18 A; insulated; blue	<a href="http://www.wago.com/859-407/000-006">www.wago.com/859-407/000-006</a>
	<b>Item no.: 859-407/000-029</b> Push-in type jumper bar; 7-way; Nominal current 18 A; insulated; yellow	<a href="http://www.wago.com/859-407/000-029">www.wago.com/859-407/000-029</a>
	<b>Item no.: 859-408</b> Push-in type jumper bar; 8-way; Nominal current 18 A; insulated; light gray	<a href="http://www.wago.com/859-408">www.wago.com/859-408</a>
	<b>Item no.: 859-408/000-005</b> Push-in type jumper bar; 8-way; Nominal current 18 A; insulated; red	<a href="http://www.wago.com/859-408/000-005">www.wago.com/859-408/000-005</a>
	<b>Item no.: 859-408/000-006</b> Push-in type jumper bar; 8-way; Nominal current 18 A; insulated; blue	<a href="http://www.wago.com/859-408/000-006">www.wago.com/859-408/000-006</a>
	<b>Item no.: 859-408/000-029</b> Push-in type jumper bar; 8-way; Nominal current 18 A; insulated; yellow	<a href="http://www.wago.com/859-408/000-029">www.wago.com/859-408/000-029</a>
	<b>Item no.: 859-409</b> Push-in type jumper bar; 9-way; Nominal current 18 A; insulated; light gray	<a href="http://www.wago.com/859-409">www.wago.com/859-409</a>
	<b>Item no.: 859-409/000-005</b> Push-in type jumper bar; 9-way; Nominal current 18 A; insulated; red	<a href="http://www.wago.com/859-409/000-005">www.wago.com/859-409/000-005</a>
	<b>Item no.: 859-409/000-006</b> Push-in type jumper bar; 9-way; Nominal current 18 A; insulated; blue	<a href="http://www.wago.com/859-409/000-006">www.wago.com/859-409/000-006</a>
	<b>Item no.: 859-409/000-029</b> Push-in type jumper bar; 9-way; Nominal current 18 A; insulated; yellow	<a href="http://www.wago.com/859-409/000-029">www.wago.com/859-409/000-029</a>
	<b>Item no.: 859-410</b> Push-in type jumper bar; 10-way; Nominal current 18 A; insulated; light gray	<a href="http://www.wago.com/859-410">www.wago.com/859-410</a>
	<b>Item no.: 859-410/000-005</b> Push-in type jumper bar; 10-way; Nominal current 18 A; insulated; red	<a href="http://www.wago.com/859-410/000-005">www.wago.com/859-410/000-005</a>
	<b>Item no.: 859-410/000-006</b> Push-in type jumper bar; 10-way; Nominal current 18 A; insulated; blue	<a href="http://www.wago.com/859-410/000-006">www.wago.com/859-410/000-006</a>
	<b>Item no.: 859-410/000-029</b> Push-in type jumper bar; 10-way; Nominal current 18 A; insulated; yellow	<a href="http://www.wago.com/859-410/000-029">www.wago.com/859-410/000-029</a>

**tools**

Subject to changes. Please also observe the further product documentation!



	<b>Item no.: 210-720</b> Operating tool; Blade: 3.5 x 0.5 mm; with a partially insulated shaft	<a href="http://www.wago.com/210-720">www.wago.com/210-720</a>
<b>check</b>		
	<b>Item no.: 859-500</b> Test pin; 1 mm Ø; with solder connection for test wire	<a href="http://www.wago.com/859-500">www.wago.com/859-500</a>
<b>ferrule</b>		
	<b>Item no.: 216-221</b> Ferrule; Sleeve for 0.5 mm <sup>2</sup> / 20 AWG; insulated; electro-tin plated; white	<a href="http://www.wago.com/216-221">www.wago.com/216-221</a>
	<b>Item no.: 216-222</b> Ferrule; Sleeve for 0.75 mm <sup>2</sup> / 18 AWG; insulated; electro-tin plated; gray	<a href="http://www.wago.com/216-222">www.wago.com/216-222</a>
	<b>Item no.: 216-223</b> Ferrule; Sleeve for 1 mm <sup>2</sup> / AWG 18; insulated; electro-tin plated; red	<a href="http://www.wago.com/216-223">www.wago.com/216-223</a>
	<b>Item no.: 216-224</b> Ferrule; Sleeve for 1.5 mm <sup>2</sup> / AWG 16; insulated; electro-tin plated; black	<a href="http://www.wago.com/216-224">www.wago.com/216-224</a>
	<b>Item no.: 216-321</b> Ferrule; Sleeve for 0.25 mm <sup>2</sup> / AWG 24; insulated; electro-tin plated; yellow	<a href="http://www.wago.com/216-321">www.wago.com/216-321</a>
	<b>Item no.: 216-322</b> Ferrule; Sleeve for 0.34 mm <sup>2</sup> / 22 AWG; insulated; electro-tin plated; green	<a href="http://www.wago.com/216-322">www.wago.com/216-322</a>

## Downloads

### Documentation

#### Bid Text

859-753 GAEB X81 - Datei	Feb 19, 2019	xml 3.9 kB	Download
859-753 GAEB docx - Datei	Feb 20, 2019	docx 15.9 kB	Download

#### Instruction Leaflet

Relay modules, Optocoupler modules	V 1.2.0 Aug 30, 2019	pdf 2.2 MB	Download
------------------------------------	-------------------------	---------------	----------

#### Additional Information

Disposal; Electrical and electronic equipment, Packaging	V 1.0.0	pdf 265.8 kB	Download
--	---------	-----------------	----------

Subject to changes. Please also observe the further product documentation!

## CAD/CAE-Data

### CAD data

2D/3D Models 859-753	URL	Download
----------------------	-----	----------

### CAE data

EPLAN Data Portal 859-753	URL	Download
---------------------------	-----	----------

WSCAD Universe 859-753	URL	Download
------------------------	-----	----------

## Installation Notes

### Inserting a conductor

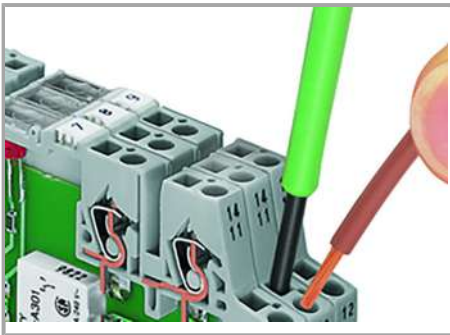

Connection of conductor

### Jumpered

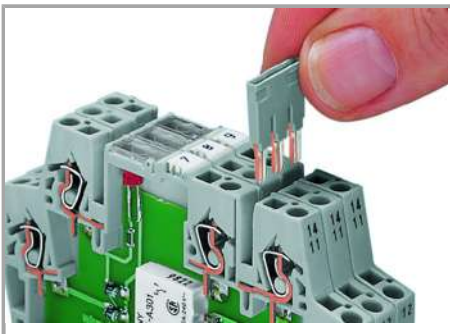

Easy commoning using adjacent jumpers

### Marking

Subject to changes. Please also observe the further product documentation!



Marking using miniature WSB quick marking card

Subject to changes. Please also observe the further product documentation!