

Data sheet | Item number: 859-796

Optocoupler module; Nominal input voltage: 24 VDC; Output voltage range: 0 ... 24 VDC; Limiting continuous current: 0.1 A; 2-wire connection; Frequency: 10 kHz; Module width: 6 mm; gray

www.wago.com/859-796

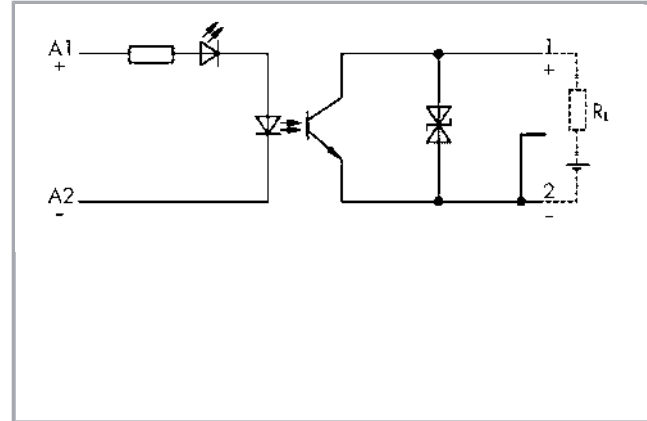
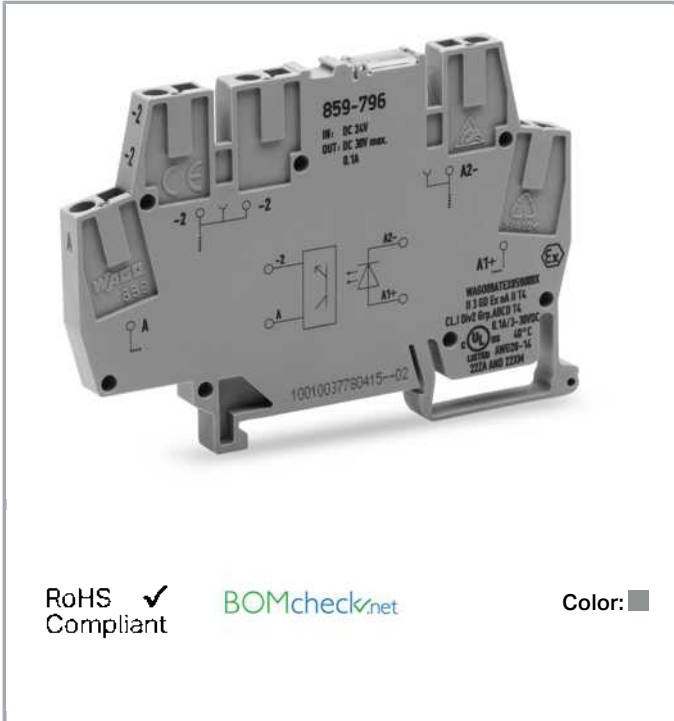

RoHS Compliant

BOMcheck.net

Color:

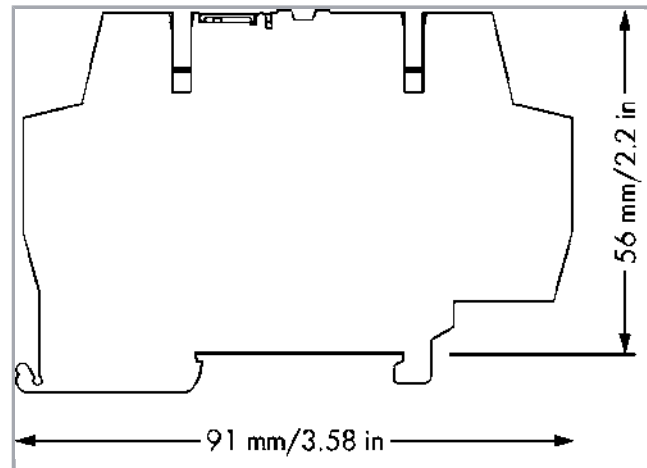
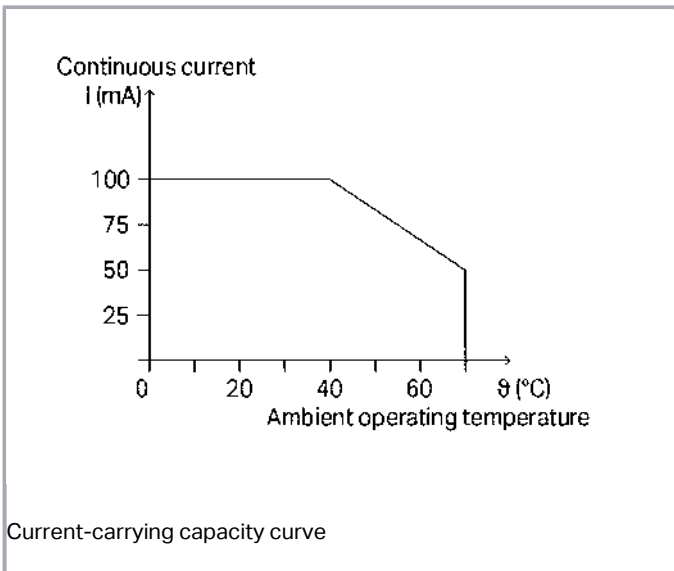

Item description

Subject to changes. Please also observe the further product documentation!

WAGO Kontakttechnik GmbH & Co. KG
Hansastr. 27
32423 Minden
Phone: +49571 887-0 | Fax: +49571 887-169
Email: info.de@wago.com | Web: www.wago.com

Do you have any questions about our products?
We are always happy to take your call at +49 (571) 887-44222.

Note:

Optocouplers and solid state relays are designed for use in signal processing networks, which are not supplied by the low-voltage power supply networks.

Data**Technical Data****Control circuit**

Nominal input voltage U_N	DC 24 V
Input voltage range (low level)	DC 0 ... 5 V
Input voltage range (high level)	DC 16,8 ... 30 V
Nominal input current at U_N	9,2 mA

Load circuit:

Circuit type	2-wire connection
Limiting continuous current	0,1 A
Nominal output voltage	DC 24 V
Output voltage range	DC 3 ... 30 V
Max. voltage drop at output	\leq DC 1 V
Leakage current at nominal voltage	\leq 25 μ A
Turn-on time	\leq 10 μ s
Drop-out time	\leq 50 μ s
Switching frequency	\leq 10 kHz

Signaling

Status indication	Red LED
-------------------	---------

Safety and protection:

Rated voltage	300 V
Overvoltage category	II
Pollution degree	2
Dielectric strength, control/load circuit (AC, 1 min)	2,5 kVrms
Insulation type (control/load circuit)	Basic insulation
Insulation type (adjacent devices)	Reinforced insulation (safe isolation)

Subject to changes. Please also observe the further product documentation!



Connection data

Connection technology	CAGE CLAMP®
Solid conductor	0,08 ... 2,5 mm ² / 28 ... 14 AWG
Fine-stranded conductor	0,08 ... 2,5 mm ² / 28 ... 14 AWG
Strip length	5 ... 6 mm / 0.2 ... 0.24 inch

Geometrical Data

Width	6 mm / 0.236 inch
Height from upper-edge of DIN-35 rail	56 mm / 2.205 inch
Depth	91 mm / 3.583 inch

Mechanical data

Type of mounting	DIN-35 rail
------------------	-------------

Material Data

Color	gray
Fire load	0.313 MJ
Weight	18.1 g

Environmental Requirements

Surrounding air (operating) temperature at U _N	-40 ... 70 °C
Surrounding air (storage) temperature	-40 ... 70 °C
Processing temperature	-25 ... +50 °C

Standards and specifications

Standards/specifications	EN 60664-1; EN 61000-6-2; EN 61000-6-3; EN 50121-3-2; EN 61373; UL 508
--------------------------	--

Commercial data

Product Group	6 (Interface Electronics)
Packaging type	BOX
Country of origin	DE
GTIN	4055143606479
Customs Tariff No.	85365005000

Subject to changes. Please also observe the further product documentation!

Approvals / Certificates

UL-Approvals

Logo	Approval	Additional Approval Text	Certificate name
	UL UL International Netherlands B.V. (ORDINARY LOCATIONS)	UL 508	E175199 Sec.4







Counterpart

Compatible products















End plate

	Item no.: 859-525 End and intermediate plate; 1 mm thick; gray	www.wago.com/859-525
--	--	--

Jumper















	Item no.: 859-402 Push-in type jumper bar; 2-way; Nominal current 18 A; insulated; light gray	www.wago.com/859-402
	Item no.: 859-402/000-005 Push-in type jumper bar; 2-way; Nominal current 18 A; insulated; red	www.wago.com/859-402/000-005
	Item no.: 859-402/000-006 Push-in type jumper bar; 2-way; Nominal current 18 A; insulated; blue	www.wago.com/859-402/000-006
	Item no.: 859-402/000-029 Push-in type jumper bar; 2-way; Nominal current 18 A; insulated; yellow	www.wago.com/859-402/000-029
	Item no.: 859-403 Push-in type jumper bar; 3-way; Nominal current 18 A; insulated; light gray	www.wago.com/859-403
	Item no.: 859-403/000-005 Push-in type jumper bar; 3-way; Nominal current 18 A; insulated; red	www.wago.com/859-403/000-005

Subject to changes. Please also observe the further product documentation!













	Item no.: 859-403/000-006 Push-in type jumper bar; 3-way; Nominal current 18 A; insulated; blue	www.wago.com/859-403/000-006
	Item no.: 859-403/000-029 Push-in type jumper bar; 3-way; Nominal current 18 A; insulated; yellow	www.wago.com/859-403/000-029
	Item no.: 859-404 Push-in type jumper bar; 4-way; Nominal current 18 A; insulated; light gray	www.wago.com/859-404
	Item no.: 859-404/000-005 Push-in type jumper bar; 4-way; Nominal current 18 A; insulated; red	www.wago.com/859-404/000-005
	Item no.: 859-404/000-006 Push-in type jumper bar; 4-way; Nominal current 18 A; insulated; blue	www.wago.com/859-404/000-006
	Item no.: 859-404/000-029 Push-in type jumper bar; 4-way; Nominal current 18 A; insulated; yellow	www.wago.com/859-404/000-029
	Item no.: 859-405 Push-in type jumper bar; 5-way; Nominal current 18 A; insulated; light gray	www.wago.com/859-405
	Item no.: 859-405/000-005 Push-in type jumper bar; 5-way; Nominal current 18 A; insulated; red	www.wago.com/859-405/000-005
	Item no.: 859-405/000-006 Push-in type jumper bar; 5-way; Nominal current 18 A; insulated; blue	www.wago.com/859-405/000-006
	Item no.: 859-405/000-029 Push-in type jumper bar; 5-way; Nominal current 18 A; insulated; yellow	www.wago.com/859-405/000-029
	Item no.: 859-406 Push-in type jumper bar; 6-way; Nominal current 18 A; insulated; light gray	www.wago.com/859-406
	Item no.: 859-406/000-005 Push-in type jumper bar; 6-way; Nominal current 18 A; insulated; red	www.wago.com/859-406/000-005
	Item no.: 859-406/000-006 Push-in type jumper bar; 6-way; Nominal current 18 A; insulated; blue	www.wago.com/859-406/000-006
	Item no.: 859-406/000-029 Push-in type jumper bar; 6-way; Nominal current 18 A; insulated; yellow	www.wago.com/859-406/000-029

Item no.: 859-407















Subject to changes. Please also observe the further product documentation!

	Push-in type jumper bar; 7-way; Nominal current 18 A; insulated; light gray	www.wago.com/859-407
	Item no.: 859-407/000-005 Push-in type jumper bar; 7-way; Nominal current 18 A; insulated; red	www.wago.com/859-407/000-005
	Item no.: 859-407/000-006 Push-in type jumper bar; 7-way; Nominal current 18 A; insulated; blue	www.wago.com/859-407/000-006
	Item no.: 859-407/000-029 Push-in type jumper bar; 7-way; Nominal current 18 A; insulated; yellow	www.wago.com/859-407/000-029
	Item no.: 859-408 Push-in type jumper bar; 8-way; Nominal current 18 A; insulated; light gray	www.wago.com/859-408
	Item no.: 859-408/000-005 Push-in type jumper bar; 8-way; Nominal current 18 A; insulated; red	www.wago.com/859-408/000-005
	Item no.: 859-408/000-006 Push-in type jumper bar; 8-way; Nominal current 18 A; insulated; blue	www.wago.com/859-408/000-006
	Item no.: 859-408/000-029 Push-in type jumper bar; 8-way; Nominal current 18 A; insulated; yellow	www.wago.com/859-408/000-029
	Item no.: 859-409 Push-in type jumper bar; 9-way; Nominal current 18 A; insulated; light gray	www.wago.com/859-409
	Item no.: 859-409/000-005 Push-in type jumper bar; 9-way; Nominal current 18 A; insulated; red	www.wago.com/859-409/000-005
	Item no.: 859-409/000-006 Push-in type jumper bar; 9-way; Nominal current 18 A; insulated; blue	www.wago.com/859-409/000-006
	Item no.: 859-409/000-029 Push-in type jumper bar; 9-way; Nominal current 18 A; insulated; yellow	www.wago.com/859-409/000-029
	Item no.: 859-410 Push-in type jumper bar; 10-way; Nominal current 18 A; insulated; light gray	www.wago.com/859-410
	Item no.: 859-410/000-005 Push-in type jumper bar; 10-way; Nominal current 18 A; insulated; red	www.wago.com/859-410/000-005

Subject to changes. Please also observe the further product documentation!

	Item no.: 859-410/000-006 Push-in type jumper bar; 10-way; Nominal current 18 A; insulated; blue	www.wago.com/859-410/000-006
	Item no.: 859-410/000-029 Push-in type jumper bar; 10-way; Nominal current 18 A; insulated; yellow	www.wago.com/859-410/000-029
check		
	Item no.: 859-500 Test pin; 1 mm Ø; with solder connection for test wire	www.wago.com/859-500
tools		
	Item no.: 210-720 Operating tool; Blade: 3.5 x 0.5 mm; with a partially insulated shaft	www.wago.com/210-720
Marking accessories		
	Item no.: 2009-145 Mini-WSB Inline; for Smart Printer; 1700 pieces on roll; stretchable 5 - 5.2 mm; plain; snap-on type; white	www.wago.com/2009-145
	Item no.: 2009-145/000-002 Mini-WSB Inline; for Smart Printer; 1700 pieces on roll; stretchable 5 - 5.2 mm; plain; snap-on type; yellow	www.wago.com/2009-145/000-002
	Item no.: 2009-145/000-005 Mini-WSB Inline; for Smart Printer; 1700 pieces on roll; stretchable 5 - 5.2 mm; plain; snap-on type; red	www.wago.com/2009-145/000-005
	Item no.: 2009-145/000-006 Mini-WSB Inline; for Smart Printer; 1700 pieces on roll; stretchable 5 - 5.2 mm; plain; snap-on type; blue	www.wago.com/2009-145/000-006
	Item no.: 2009-145/000-007 Mini-WSB Inline; for Smart Printer; 1700 pieces on roll; stretchable 5 - 5.2 mm; plain; snap-on type; gray	www.wago.com/2009-145/000-007
	Item no.: 2009-145/000-012 Mini-WSB Inline; for Smart Printer; 1700 pieces on roll; stretchable 5 - 5.2 mm; plain; snap-on type; orange	www.wago.com/2009-145/000-012
	Item no.: 2009-145/000-023 Mini-WSB Inline; for Smart Printer; 1700 pieces on roll; stretchable 5 - 5.2 mm; plain; snap-on type; green	www.wago.com/2009-145/000-023
	Item no.: 2009-145/000-024 Mini-WSB Inline; for Smart Printer; 1700 pieces on roll; stretchable 5 - 5.2 mm; plain; snap-on type; violet	www.wago.com/2009-145/000-024
	Item no.: 210-110 Fiber-tip pen	www.wago.com/210-110

Subject to changes. Please also observe the further product documentation!

	Item no.: 248-501 Miniature WSB Quick marking system; plain; Marker width 5 mm; 10 strips with 10 markers per card	www.wago.com/248-501
	Item no.: 248-501/000-002 Mini-WSB marking card; as card; not stretchable; plain; snap-on type; yellow	www.wago.com/248-501/000-002
	Item no.: 248-501/000-005 Mini-WSB marking card; as card; not stretchable; plain; snap-on type; red	www.wago.com/248-501/000-005
	Item no.: 248-501/000-006 Mini-WSB marking card; as card; not stretchable; plain; snap-on type; blue	www.wago.com/248-501/000-006
	Item no.: 248-501/000-007 Mini-WSB marking card; as card; not stretchable; plain; snap-on type; gray	www.wago.com/248-501/000-007
	Item no.: 248-501/000-012 Mini-WSB marking card; as card; not stretchable; plain; snap-on type; orange	www.wago.com/248-501/000-012
	Item no.: 248-501/000-017 Mini-WSB marking card; as card; not stretchable; plain; snap-on type; light green	www.wago.com/248-501/000-017
	Item no.: 248-501/000-023 Mini-WSB marking card; as card; not stretchable; plain; snap-on type; green	www.wago.com/248-501/000-023
	Item no.: 248-501/000-024 Mini-WSB marking card; as card; not stretchable; plain; snap-on type; violet	www.wago.com/248-501/000-024
	Item no.: 248-502 Mini-WSB marking card; as card; MARKED; 1 ... 10 (10x); not stretchable; Horizontal marking; snap-on type; white	www.wago.com/248-502
	Item no.: 248-502/000-024 Mini-WSB marking card; as card; MARKED; 1 ... 10 (10x); not stretchable; Horizontal marking; snap-on type; violet	www.wago.com/248-502/000-024
	Item no.: 248-503 Mini-WSB marking card; as card; MARKED; 11 ... 20 (10x); not stretchable; Horizontal marking; snap-on type; white	www.wago.com/248-503
	Item no.: 248-503/000-024 Mini-WSB marking card; as card; MARKED; 11 ... 20 (10x); not stretchable; Horizontal marking; snap-on type; violet	www.wago.com/248-503/000-024
	Item no.: 248-504 Mini-WSB marking card; as card; MARKED; 21 ... 30 (10x); not stretchable; Horizontal marking; snap-on type; white	www.wago.com/248-504

Subject to changes. Please also observe the further product documentation!

**Item no.: 248-504/000-024**

Mini-WSB marking card; as card; MARKED; 21 ... 30 (10x); not stretchable; Horizontal marking; snap-on type; violet

www.wago.com/248-504/000-024**Item no.: 248-505/000-024**

Mini-WSB marking card; as card; MARKED; 31 ... 40 (10x); not stretchable; Horizontal marking; snap-on type; violet

www.wago.com/248-505/000-024**Item no.: 248-506**

Mini-WSB marking card; as card; MARKED; 41 ... 50 (10x); not stretchable; Horizontal marking; snap-on type; white

www.wago.com/248-506**ferrule****Item no.: 216-221**Ferrule; Sleeve for 0.5 mm² / 20 AWG; insulated; electro-tin plated; whitewww.wago.com/216-221**Item no.: 216-222**Ferrule; Sleeve for 0.75 mm² / 18 AWG; insulated; electro-tin plated; graywww.wago.com/216-222**Item no.: 216-223**Ferrule; Sleeve for 1 mm² / AWG 18; insulated; electro-tin plated; redwww.wago.com/216-223**Item no.: 216-224**Ferrule; Sleeve for 1.5 mm² / AWG 16; insulated; electro-tin plated; blackwww.wago.com/216-224**Item no.: 216-321**Ferrule; Sleeve for 0.25 mm² / AWG 24; insulated; electro-tin plated; yellowwww.wago.com/216-321**Item no.: 216-322**Ferrule; Sleeve for 0.34 mm² / 22 AWG; insulated; electro-tin plated; greenwww.wago.com/216-322**Downloads****Documentation****Bid Text**

859-796 GAEB docx - Datei	Feb 20, 2019	docx 15.7 kB	Download
------------------------------	--------------	-----------------	----------

859-796 GAEB X81 - Datei	Feb 19, 2019	xml 3.9 kB	Download
-----------------------------	--------------	---------------	----------

Instruction Leaflet

Relay modules, Optocoupler modules	V 1.2.0 Aug 30, 2019	pdf 2.2 MB	Download
------------------------------------	-------------------------	---------------	----------

Additional Information

Disposal; Electrical and electronic equipment, Packaging	V 1.0.0	pdf	Download
--	---------	-----	----------

Subject to changes. Please also observe the further product documentation!

CAD/CAE-Data

CAD data

2D/3D Models 859-796	URL	Download
----------------------	---------------------	--------------------------

CAE data

EPLAN Data Portal 859-796	URL	Download
---------------------------	---------------------	--------------------------

WSCAD Universe 859-796	URL	Download
------------------------	---------------------	--------------------------

Installation Notes

Inserting a conductor

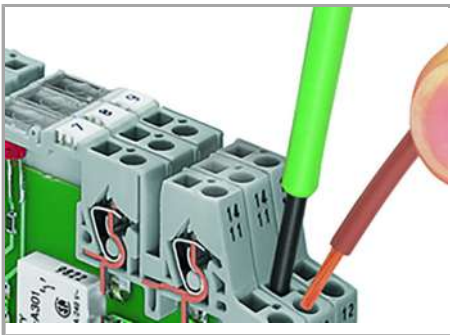

Connection of conductor

Jumpered

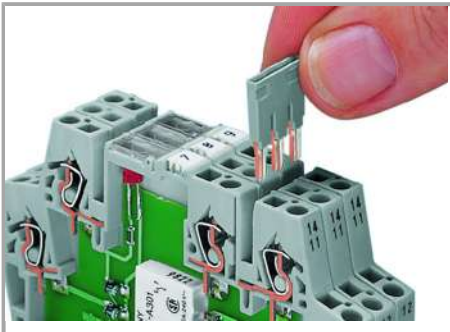

Easy commoning using adjacent jumpers

Subject to changes. Please also observe the further product documentation!

Marking



Marking using miniature WSB quick marking card

Subject to changes. Please also observe the further product documentation!