

Data sheet | Item number: 885-308

Stud terminal block; lateral marker slots; for DIN-rail 35 x 15 and 35 x 7.5; 3 studs, M8; 50,00 mm²; gray

www.wago.com/885-308

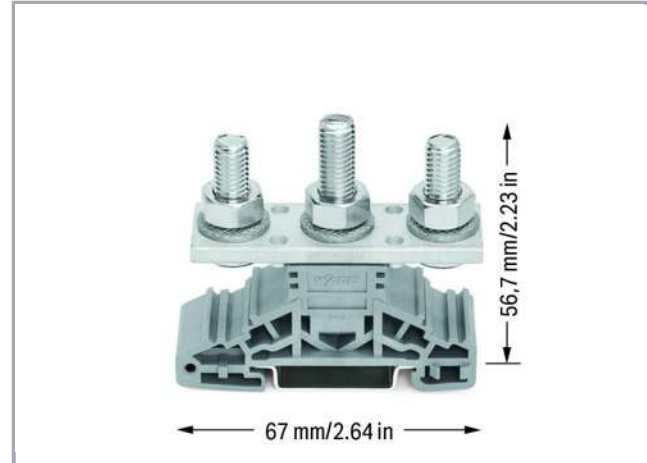
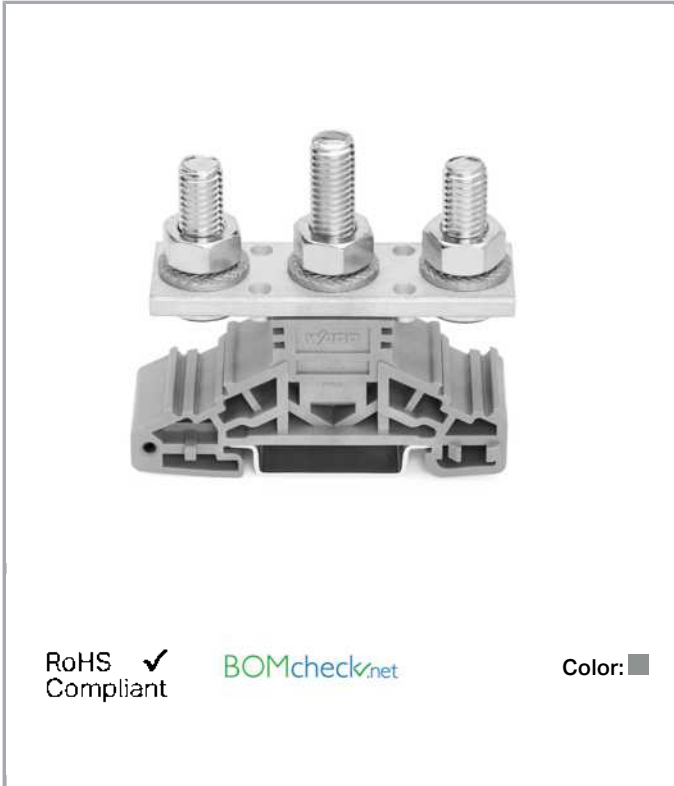

Data

Electrical data

Ratings per IEC/EN 60664-1

Rated voltage (III / 3)	1000 V
Rated impulse voltage (III / 3)	8 kV
Rated current	150 A
Legend (ratings)	(III / 3) ≙ Overvoltage category III / Pollution degree 3

Approvals per UL 1059

Approvals per	UL 1059
---------------	---------

Subject to changes. Please also observe the further product documentation!

WAGO Kontakttechnik GmbH & Co. KG
Hansastr. 27
32423 Minden
Phone: +49571 887-0 | Fax: +49571 887-169
Email: info.de@wago.com | Web: www.wago.com

Do you have any questions about our products?
We are always happy to take your call at +49 (571) 887-44222.



Connection data

Connection technology	Studs connection
Actuation type	Operating tool
Connectable conductor materials	Copper
Total number of connection points	2
Total number of potentials	1

Geometrical Data

Width	22,8 mm / 0.898 inch
Height from upper-edge of DIN-35 rail	56,7 mm / 2.232 inch
Depth	67 mm / 2.638 inch

Mechanical data

Tightening torque	6 ... 12 Nm
Type of mounting	DIN-35 rail
Marking level	Side marking

Material Data

Color	gray
Fire load	0.537 MJ
Weight	121.8 g

Commercial data

Product Group	1 (Rail Mounted Terminal Blocks)
Packaging type	BOX
Country of origin	CN
GTIN	4050821049265
Customs Tariff No.	85369095990

Approvals / Certificates

Country specific Approvals

Logo	Approval	Additional Approval Text	Certificate name
	CCA DEKRA Certification B.V.	EN 60947	NTR NL 6882

Subject to changes. Please also observe the further product documentation!

WAGO Kontakttechnik GmbH & Co. KG
 Hansastr. 27
 32423 Minden
 Phone: +49571 887-0 | Fax: +49571 887-169
 Email: info.de@wago.com | Web: www.wago.com

Do you have any questions about our products?
 We are always happy to take your call at +49 (571) 887-44222.

CCA

	CCA DEKRA Certification B.V.	EN 60947	2145295.01
--	---------------------------------	----------	------------

	CSA DEKRA Certification B.V.	C22.2 No. 158	70038960
--	---------------------------------	---------------	----------

UL-Approvals

Logo	Approval	Additional Approval Text	Certificate name
	UL UL International Germany GmbH	UL 1059	E45172-20120322



Counterpart

Compatible products

General accessories

	Item no.: 885-580 Clip; secures cover against slipping	www.wago.com/885-580
--	---	--















Marking accessories

	Item no.: 2009-110 Marking strips; on reel; not stretchable; plain; snap-on type; white	www.wago.com/2009-110
	Item no.: 2009-115 WMB-Inline; for Smart Printer; 1500 pieces on roll; stretchable 5 - 5.2 mm; plain; snap-on type; white	www.wago.com/2009-115
	Item no.: 2009-115/000-002 WMB-Inline; for Smart Printer; 1500 pieces on roll; stretchable 5 - 5.2 mm; plain; snap-on type; yellow	www.wago.com/2009-115/000-002

Subject to changes. Please also observe the further product documentation!

WAGO Kontakttechnik GmbH & Co. KG
 Hansastr. 27
 32423 Minden
 Phone: +49571 887-0 | Fax: +49571 887-169
 Email: info.de@wago.com | Web: www.wago.com

Do you have any questions about our products?
 We are always happy to take your call at +49 (571) 887-44222.

	<p>Item no.: 2009-115/000-006 WMB-Inline; for Smart Printer; 1500 pieces on roll; stretchable 5 - 5.2 mm; plain; snap-on type; blue</p>	www.wago.com/2009-115/000-006
	<p>Item no.: 2009-115/000-007 WMB-Inline; for Smart Printer; 1500 pieces on roll; stretchable 5 - 5.2 mm; plain; snap-on type; gray</p>	www.wago.com/2009-115/000-007
	<p>Item no.: 2009-115/000-012 WMB-Inline; for Smart Printer; 1500 pieces on roll; stretchable 5 - 5.2 mm; plain; snap-on type; orange</p>	www.wago.com/2009-115/000-012
	<p>Item no.: 2009-115/000-017 WMB-Inline; for Smart Printer; 1500 pieces on roll; stretchable 5 - 5.2 mm; plain; snap-on type; light green</p>	www.wago.com/2009-115/000-017
	<p>Item no.: 2009-115/000-023 WMB-Inline; for Smart Printer; 1500 pieces on roll; stretchable 5 - 5.2 mm; plain; snap-on type; green</p>	www.wago.com/2009-115/000-023
	<p>Item no.: 2009-115/000-024 WMB-Inline; for Smart Printer; 1500 pieces on roll; stretchable 5 - 5.2 mm; plain; snap-on type; violet</p>	www.wago.com/2009-115/000-024
	<p>Item no.: 2009-135 WMB-Inline; for Smart Printer; on reel; stretchable 5 - 5.2 mm; plain; snap-on type; white</p>	www.wago.com/2009-135
	<p>Item no.: 2009-198 Adaptor</p>	www.wago.com/2009-198
Jumper		
	<p>Item no.: 885-408 Assembled jumper bar; 2-way</p>	www.wago.com/885-408
	<p>Item no.: 885-428 Assembled jumper bar; 3-way</p>	www.wago.com/885-428
	<p>Item no.: 885-448 Step-down adjacent jumper bar; 1 level; from M8 to M6</p>	www.wago.com/885-448
End plate		
	<p>Item no.: 885-528 Separator plate; 2 mm thick; 110.3 mm wide; gray</p>	www.wago.com/885-528
	<p>Item no.: 885-548 Separator plate with jumper bar recess; 2 mm thick; 110.3 mm wide; gray</p>	www.wago.com/885-548
N-busbar		
	<p>Item no.: 885-566 Cover; 1 m long; transparent</p>	www.wago.com/885-566

Subject to changes. Please also observe the further product documentation!



Downloads

Documentation

Additional Information

Technical explanations	Apr 3, 2019	pdf 2.1 MB	Download
------------------------	-------------	---------------	----------

CAD/CAE-Data

CAD data

2D/3D Models 885-308	URL	Download
----------------------	-----	----------

CAE data

EPLAN Data Portal 885-308	URL	Download
---------------------------	-----	----------

WSCAD Universe 885-308	URL	Download
------------------------	-----	----------

Installation Notes

Subject to changes. Please also observe the further product documentation!