

## Data sheet | Item number: 890-1735

3-way distribution connector; 4-pole; Cod. B; 1 input; 3 outputs; light green

[www.wago.com/890-1735](http://www.wago.com/890-1735)

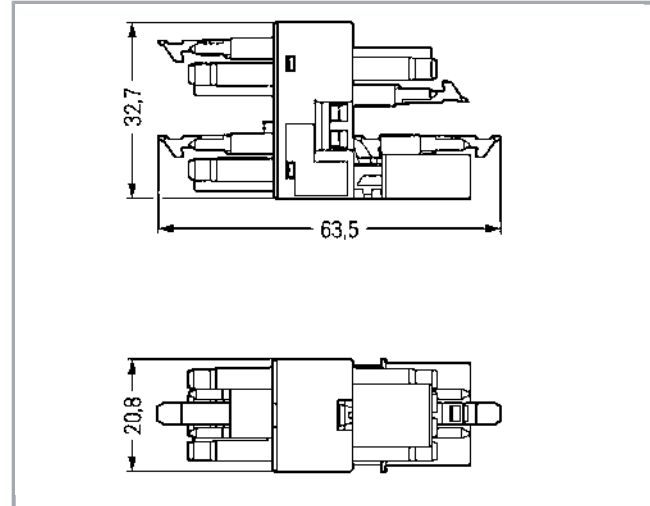
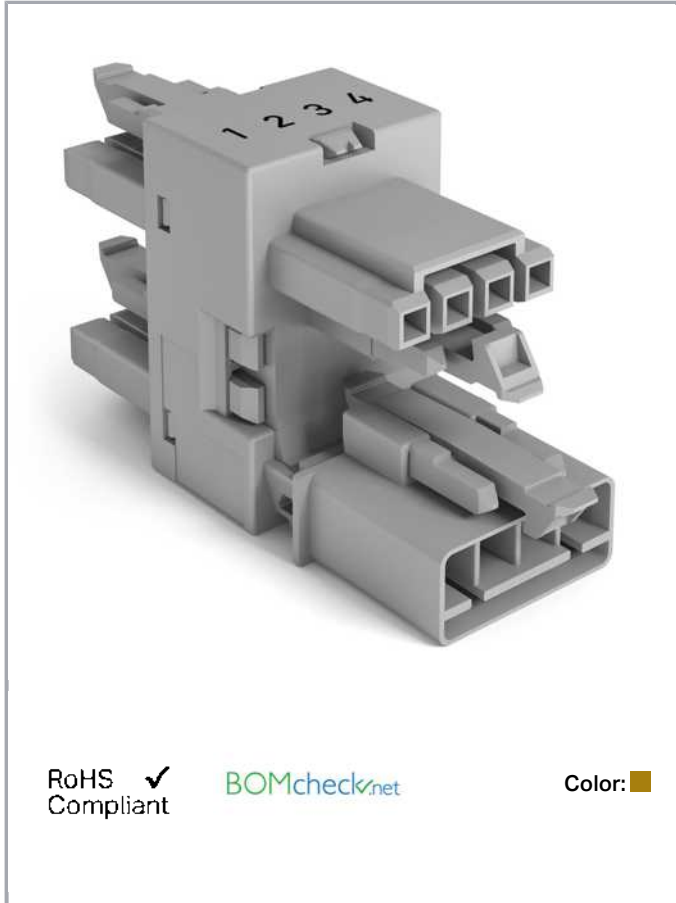

### Item description

- Protected against mismatching and maintenance-free
- Compact design with 4.4 mm pole spacing
- Components can be clearly printed on and color-coded to meet custom requirements

#### Note:

All connectors for mounted installations (snap-in versions for lighting fixtures or devices, all types of PCB and distribution connectors) are factory-equipped with locking levers to ensure plugs and sockets are securely locked. Additional locking levers are only required for flying leads (plug /socket).

#### Note on mismatching protection:

All WINSTA<sup>®</sup> components are 100% protected against mismatching when:  
a.) plugging different numbers of poles

Subject to changes. Please also observe the further product documentation!

WAGO Kontakttechnik GmbH & Co. KG  
Hansastr. 27  
32423 Minden  
Phone: +49571 887-0 | Fax: +49571 887-169  
Email: [info.de@wago.com](mailto:info.de@wago.com) | Web: [www.wago.com](http://www.wago.com)

Do you have any questions about our products?  
We are always happy to take your call at +49 (571) 887-44222.



- b.) plugging while rotated 180
- c.) plugging while laterally staggered
- d.) plugging one pole

**Safety information 1:**

Application note for the U.S. market (USR): Some versions may also be used for current interruption in accordance with the UL certificate in select applications with currents below 5 A and voltages up to 600 V. For further information, please contact your local sales office.

**Data****Electrical data**

Note on Contact Resistance	approx. 1 mΩ of contact resistance approx. 0.25 mΩ contact transition plug/socket
----------------------------	---

**Ratings per IEC/EN 60664-1**

Ratings per	IEC/EN 60664-1
Rated voltage (III / 3)	400 V
Rated impulse voltage (III / 3)	6 kV
Rated current	16 A
Legend (ratings)	(III / 3) ≙ Overvoltage category III / Pollution degree 3

**Approvals per UL 1977**

Rated voltage per UL 1977 (factory wiring only)	600 V
Rated current per UL 1977 (factory wiring only)	12 A

**Connection data**

No. of poles	4
Total number of potentials	4

**Geometrical Data**

Pin spacing	4,4 mm / 0.173 inch
Width	20,8 mm / 0.819 inch
Height	32,65 mm / 1.285 inch
Depth	63,5 mm / 2.5 inch

**Mechanical data**

Coding	B
Mating force of a plug-in connection	approx. 20 ... 70 N (depending on pole number)
Retention force of a plug-in connection	When locked: > 80 N

Subject to changes. Please also observe the further product documentation!



Unmating force of a plug-in connection	when unlocked: approx. 20 ... 70 N (depending on pole number)
Number of mating cycles	200, without resistive load 100, with resistive load $I_N = 16$ A, tested (1.5 mm <sup>2</sup> /16 AWG)
Type of distribution connector	Distribution connector, 3-way,
Marking	1 2 3 4
Protection class	IP20
Note on protection class	IP40 when mated
Potential marking	1 2 3 4

### Plug connection

Contact type (pluggable connector)	Socket/plug
Mismating protection	Yes
Locking of plug-in connection	locking lever
Locking lever	yes

### Material Data

Color	light green
Insulating material	Polyamide 66 (PA 66)
Contact material	Copper or copper alloy (surface-treated)
Fire load	0.355 MJ
Weight	22.2 g

### Environmental Requirements

Processing temperature	-5 ... +40 °C
Continuous operating temperature	-35 ... +85 °C
Note on Continuous Service Temperature	Insulating parts for temperatures $\leq 105$ °C

### Commercial data

Packaging type	BOX
Country of origin	DE
GTIN	4050821876397
Customs Tariff No.	85366990990



### Approvals / Certificates

Subject to changes. Please also observe the further product documentation!

WAGO Kontakttechnik GmbH & Co. KG  
 Hansastr. 27  
 32423 Minden  
 Phone: +49571 887-0 | Fax: +49571 887-169  
 Email: [info.de@wago.com](mailto:info.de@wago.com) | Web: [www.wago.com](http://www.wago.com)

Do you have any questions about our products?  
 We are always happy to take your call at +49 (571) 887-44222.

## Country specific Approvals

Logo	Approval	Additional Approval Text	Certificate name
	<b>CB</b> DEKRA Certification B.V.	EN 61984	71-100413
	<b>CCA</b> DEKRA Certification B.V.	EN 60320	2148952.04





## Ship Approvals

Logo	Approval	Additional Approval Text	Certificate name
	<b>DNV GL</b> Det Norske Veritas, Germanischer Lloyd	-	TAE00001Z6

## UL-Approvals

Logo	Approval	Additional Approval Text	Certificate name
	<b>cURus</b> Underwriters Laboratories Inc.	UL 1977	E45171

## Counterpart



	<b>Item no.891-8994/005-105</b> pre-assembled interconnecting cable; Eca; Socket/plug; 4-pole; Cod. B; Control cable 4 x 1.0 mm <sup>2</sup> ; 1 m; 1,00 mm <sup>2</sup> ; light green	<a href="http://www.wago.com/891-8994/005-105">www.wago.com/891-8994/005-105</a>
	<b>Item no.890-274</b> Plug; 4-pole; 1,50 mm <sup>2</sup> ; light green	<a href="http://www.wago.com/890-274">www.wago.com/890-274</a>
	<b>Item no.890-264</b> Socket; 4-pole; Cod. B; 1,50 mm <sup>2</sup> ; light green	<a href="http://www.wago.com/890-264">www.wago.com/890-264</a>
	<b>Item no.891-8994/105-105</b> pre-assembled connecting cable; Eca; Socket/open-ended; 4-pole; Cod. B; Control cable 4 x 1.0 mm <sup>2</sup> ; 1 m; 1,00 mm <sup>2</sup> ; light green	<a href="http://www.wago.com/891-8994/105-105">www.wago.com/891-8994/105-105</a>
	<b>Item no.891-8994/205-105</b>	<a href="http://www.wago.com/891-8994">www.wago.com/891-8994</a>

Subject to changes. Please also observe the further product documentation!

pre-assembled connecting cable; Eca; Plug/open-ended; 4-pole; Cod. B; Control cable 4 x 1.0 mm<sup>2</sup>; 1 m; 1,00 mm<sup>2</sup>; light green /205-105

## Compatible products

### assembling

	<b>Item no.: 890-624</b> Mounting plate; 4-pole; for distribution connectors; Plastic; black	<a href="http://www.wago.com/890-624">www.wago.com/890-624</a>
	<b>Item no.: 890-674</b> Mounting plate; 4-pole; for distribution connectors; Plastic; white	<a href="http://www.wago.com/890-674">www.wago.com/890-674</a>

## Downloads

### Documentation

#### Bid Text

890-1735 doc - Datei	Dec 3, 2014	doc 23.0 kB	Download
890-1735 GAEB X81 - Datei	Feb 19, 2019	xml 2.8 kB	Download

## Installation Notes

### Installation

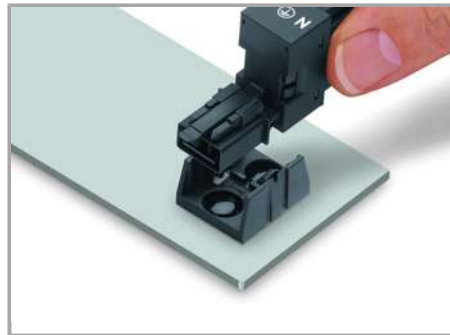

Secure the mounting plate via pins.

## Product family

<i>WINSTA</i>® MINI special  
[Show all products from the family](#)

Subject to changes. Please also observe the further product documentation!