

Data sheet | Item number: 890-804  
Socket for PCBs; straight; 4-pole; Cod. A

[www.wago.com/890-804](http://www.wago.com/890-804)

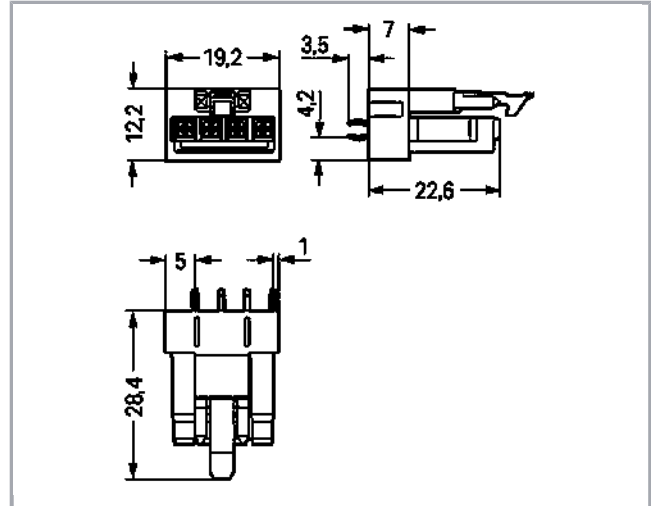

Subject to changes. Please also observe the further product documentation!

WAGO Kontakttechnik GmbH & Co. KG  
Hansastr. 27  
32423 Minden  
Phone: +49571 887-0 | Fax: +49571 887-169  
Email: [info.de@wago.com](mailto:info.de@wago.com) | Web: [www.wago.com](http://www.wago.com)

Do you have any questions about our products?  
We are always happy to take your call at +49 (571) 887-44222.

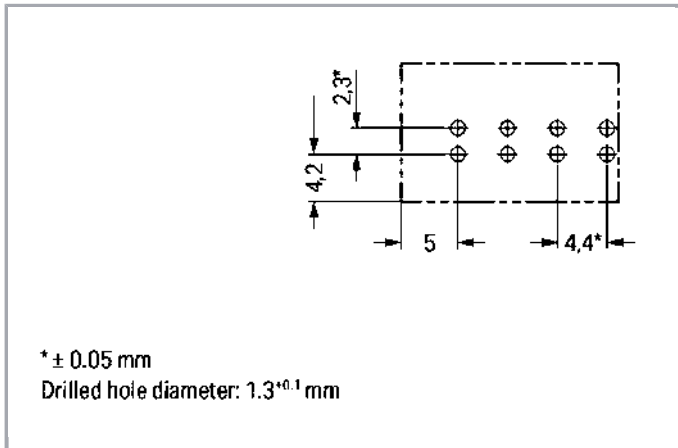

### Item description

- Protected against mismatching and maintenance-free
- Push-in CAGE CLAMP® spring pressure connection technology allows solid conductors to be simply pushed into a unit
- Compact design with 4.4 mm pole spacing

#### Note:

All connectors for mounted installations (snap-in versions for lighting fixtures or devices, all types of PCB and distribution connectors) are factory-equipped with locking levers to ensure plugs and sockets are securely locked. Additional locking levers are only required for flying leads (plug /socket).

#### Note on mismatching protection:

All WINSTA® components are 100% protected against mismatching when:

- a.) plugging different numbers of poles
- b.) plugging while rotated 180
- c.) plugging while laterally staggered
- d.) plugging one pole

#### Safety information 1:

Application note for the U.S. market (USR): Some versions may also be used for current interruption in accordance with the UL certificate in select applications with currents below 5 A and voltages up to 600 V. For further information, please contact your local sales office.

## Data

### Electrical data

Note on Contact Resistance

approx. 1 mΩ of contact resistance approx. 0.25 mΩ contact transition plug/socket

### Ratings per IEC/EN 60664-1

Ratings per	IEC/EN 60664-1
Rated voltage (III / 3)	250 V

Subject to changes. Please also observe the further product documentation!

WAGO Kontakttechnik GmbH & Co. KG  
Hansastr. 27  
32423 Minden  
Phone: +49571 887-0 | Fax: +49571 887-169  
Email: [info.de@wago.com](mailto:info.de@wago.com) | Web: [www.wago.com](http://www.wago.com)

Do you have any questions about our products?  
We are always happy to take your call at +49 (571) 887-44222.



Rated impulse voltage (III / 3)	4 kV
Rated current	16 A
Legend (ratings)	(III / 3) ≙ Overvoltage category III / Pollution degree 3

### Approvals per UL 1977

Rated voltage per UL 1977 (factory wiring only)	600 V
Rated current per UL 1977 (factory wiring only)	12 A

### Connection data

No. of poles	4
Total number of potentials	4
Number of levels	1

### Geometrical Data

Pin spacing	4,4 mm / 0.173 inch
Width	19,2 mm / 0.756 inch
Height	31,9 mm / 1.256 inch
Height from the surface	28,4 mm / 1.118 inch
Depth	12,2 mm / 0.48 inch
Solder pin length	3.5 mm
Solder pin dimensions	1 x 0,8 mm
Drilled hole diameter (tolerance)	1,3 <sup>(-0,1 ... +0,1)</sup> mm

### Mechanical data

Coding	A
Mating force of a plug-in connection	approx. 20 ... 70 N (depending on pole number)
Retention force of a plug-in connection	Locked: > 80 N
Unmating force of a plug-in connection	Unlocked: approx. 20 ... 70 N (depending on pole number)
Number of mating cycles	200, without resistive load 100, with resistive load $I_N = 16$ A, tested (1.5 mm <sup>2</sup> /16 AWG)
Design	straight
Marking	N 2/L 1/L'
Potential marking	N 2/L 1/L'

Subject to changes. Please also observe the further product documentation!



Application	General mains applications
-------------	----------------------------

### Plug connection

Contact type (pluggable connector)	Female connector/socket
Connector connection type	for PCB
Mismating protection	Yes
Mating direction to the PCB	90°
Locking of plug-in connection	locking lever
Locking lever	yes

### PCB contact

PCB contact	THT
Solder pin arrangement	2 in-line solder pins/pole
Number of solder pins per potential	2

### Material Data

Color	black
Insulating material	Polyamide 66 (PA 66)
Clamping spring material	Chrome nickel spring steel (CrNi)
Contact material	Copper or copper alloy (surface-treated)
Fire load	0.075 MJ
Weight	4.4 g

### Environmental Requirements

Processing temperature	-5 ... +40 °C
Continuous operating temperature	-35 ... +85 °C
Note on Continuous Service Temperature	Insulating parts for temperatures ≤ 105 °C

### Commercial data

Product Group	20 (WINSTA)
Packaging type	BOX
Country of origin	PL
GTIN	4050821695479
Customs Tariff No.	85366990990

Subject to changes. Please also observe the further product documentation!

WAGO Kontakttechnik GmbH & Co. KG  
 Hansastr. 27  
 32423 Minden  
 Phone: +49571 887-0 | Fax: +49571 887-169  
 Email: [info.de@wago.com](mailto:info.de@wago.com) | Web: [www.wago.com](http://www.wago.com)



Do you have any questions about our products?  
 We are always happy to take your call at +49 (571) 887-44222.

## Approvals / Certificates

### Country specific Approvals

Logo	Approval	Additional Approval Text	Certificate name
	<b>CCA</b> DEKRA Certification B.V.	EN 61535	71- 102984



### Ship Approvals

Logo	Approval	Additional Approval Text	Certificate name
	<b>ABS</b> American Bureau of Shipping	Steel Vessel Rules	19- HG1869855- PDA
	<b>DNV GL</b> Det Norske Veritas, Germanischer Lloyd	-	TAE00001Z6
	<b>LR</b> Lloyds Register	EN 61535	08/20047 (E2)

### UL-Approvals

Logo	Approval	Additional Approval Text	Certificate name
	<b>cURus</b> Underwriters Laboratories Inc.	UL 1977	E45171

### Counterpart

	<b>Item no.890-114</b> Plug; with strain relief housing; 4-pole; 1,50 mm <sup>2</sup> ; black	<a href="http://www.wago.com/890-114">www.wago.com/890-114</a>
	<b>Item no.890-214</b> Plug; 4-pole; 1,50 mm <sup>2</sup> ; black	<a href="http://www.wago.com/890-214">www.wago.com/890-214</a>
	<b>Item no.891-8994/006-101</b>	<a href="http://www.wago.com/891-8994">www.wago.com/891-8994</a>

Subject to changes. Please also observe the further product documentation!

pre-assembled interconnecting cable; Eca; Socket/plug; 4-pole; Cod. A; H05VV-F 4G 1.5 mm<sup>2</sup>; 1 m; /006-101  
1,50 mm<sup>2</sup>; black



Item no.891-8994/206-101

pre-assembled connecting cable; Eca; Plug/open-ended; 4-pole; Cod. A; H05VV-F 4G 1.5 mm<sup>2</sup>; 1 m; /206-101  
1,50 mm<sup>2</sup>; black

[www.wago.com/891-8994/206-101](http://www.wago.com/891-8994/206-101)

## Downloads

### CAD/CAE-Data

#### CAD data

	URL	Download
2D/3D Models 890-804		

#### PCB Design

Symbol and Footprint 890-804	URL	Download
------------------------------	-----	----------

CAX data for your PCB design, consisting of "schematic symbols and PCB footprints", allow easy integration of the WAGO component into your development environment.

#### Supported formats:

- Accel EDA 14 & 15
- Altium 6 to current version
- Cadence Allegro
- DesignSpark
- Eagle Libraries
- KiCad
- Mentor Graphics BoardStation
- Mentor Graphics Design Architect
- Mentor Graphics Design Expedition 99 and 2000
- OrCAD 9.X PCB and Capture
- PADS PowerPCB 3, 3.5, 4.X, and 5.X
- PADS PowerPCB and PowerLogic 3.0
- PCAD 2000, 2001, 2002, 2004, and 2006
- Pulsonix 8.5 or newer
- STL
- 3D STEP
- TARGET 3001!
- View Logic ViewDraw
- Quadcept
- Zuken CadStar 3 and 4

Subject to changes. Please also observe the further product documentation!

WAGO Kontakttechnik GmbH & Co. KG

Hansastr. 27

32423 Minden

Phone: +49571 887-0 | Fax: +49571 887-169

Email: [info.de@wago.com](mailto:info.de@wago.com) | Web: [www.wago.com](http://www.wago.com)

Do you have any questions about our products?

We are always happy to take your call at +49 (571) 887-44222.



- Zuken CR-5000 and CR-8000

PCB Component Libraries (EDA), PCB CAD Library Ultra Librarian

---

## Installation Notes

## Product family

*WINSTA*® MINI

[Show all products from the family](#)

Subject to changes. Please also observe the further product documentation!

---

WAGO Kontakttechnik GmbH & Co. KG  
Hansastr. 27  
32423 Minden  
Phone: +49571 887-0 | Fax: +49571 887-169  
Email: [info.de@wago.com](mailto:info.de@wago.com) | Web: [www.wago.com](http://www.wago.com)

Do you have any questions about our products?  
We are always happy to take your call at +49 (571) 887-44222.