

## Data sheet | Item number: 890-945

h-distribution connector; 4-pole; Cod. A; 1 input; 2 outputs; outputs on one side; 3 locking levers; for flying leads; black

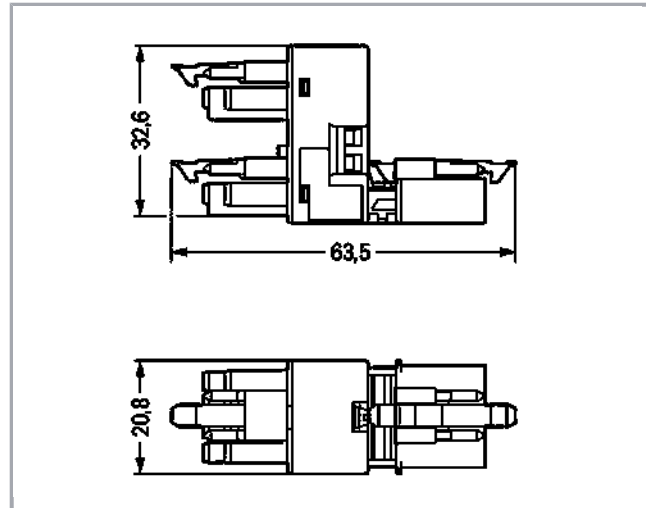

[www.wago.com/890-945](http://www.wago.com/890-945)



### Item description

- Protected against mismatching and maintenance-free
- Compact design with 4.4 mm pole spacing

#### Note:

All connectors for mounted installations (snap-in versions for lighting fixtures or devices, all types of PCB and distribution connectors) are factory-equipped with locking levers to ensure plugs and sockets are securely locked. Additional locking levers are only required for flying leads (plug /socket).

#### Note on mismatching protection:

All WINSTA<sup>®</sup> components are 100% protected against mismatching when:

- a.) plugging different numbers of poles
- b.) plugging while rotated 180
- c.) plugging while laterally staggered
- d.) plugging one pole

Subject to changes. Please also observe the further product documentation!

WAGO Kontakttechnik GmbH & Co. KG  
Hansastr. 27  
32423 Minden  
Phone: +49571 887-0 | Fax: +49571 887-169  
Email: [info.de@wago.com](mailto:info.de@wago.com) | Web: [www.wago.com](http://www.wago.com)

Do you have any questions about our products?  
We are always happy to take your call at +49 (571) 887-44222.

**Safety information 1:**

Application note for the U.S. market (USR): Some versions may also be used for current interruption in accordance with the UL certificate in select applications with currents below 5 A and voltages up to 600 V. For further information, please contact your local sales office.

**Data****Electrical data**

Note on Contact Resistance	approx. 1 mΩ of contact resistance approx. 0.25 mΩ contact transition plug/socket
----------------------------	---

**Ratings per IEC/EN 60664-1**

Ratings per	IEC/EN 60664-1
Rated voltage (III / 3)	400 V
Rated impulse voltage (III / 3)	6 kV
Rated current	16 A
Legend (ratings)	(III / 3) ≙ Overvoltage category III / Pollution degree 3

**Approvals per UL 1977**

Rated voltage per UL 1977 (factory wiring only)	600 V
Rated current per UL 1977 (factory wiring only)	12 A

**Connection data**

No. of poles	4
Total number of potentials	4
Ground function	with preceding ground contact

**Geometrical Data**

Pin spacing	4,4 mm / 0.173 inch
Width	20,8 mm / 0.819 inch
Height	32,65 mm / 1.285 inch
Depth	63,5 mm / 2.5 inch

**Mechanical data**

Coding	A
Mating force of a plug-in connection	approx. 20 ... 70 N (depending on pole number)
Retention force of a plug-in connection	When locked: > 80 N
Unmating force of a plug-in connection	when unlocked: approx. 20 ... 70 N (depending on pole number)

Subject to changes. Please also observe the further product documentation!



Number of mating cycles

200, without resistive load

100, with resistive load  $I_N = 16$  A, tested (1.5mm<sup>2</sup>/AWG 16)

Type of distribution connector	h-distribution connector (unidirectional)
Marking	N 2/L 1/L'
Protection class	IP20
Note on protection class	IP40 when mated
Potential marking	N 2/L 1/L'
Application	General mains applications
Suitable	for flying leads

### Plug connection

Contact type (pluggable connector)	Socket/plug
Mismating protection	Yes
Locking of plug-in connection	locking lever
Locking lever	yes

### Material Data

Color	black
Insulating material	Polyamide 66 (PA 66)
Contact material	Copper or copper alloy (surface-treated)
Fire load	0.314 MJ
Weight	19.3 g

### Environmental Requirements

Processing temperature	-5 ... +40 °C
Continuous operating temperature	-35 ... +85 °C
Note on Continuous Service Temperature	Insulating parts for temperatures $\leq 105$ °C

### Commercial data

Product Group	20 (WINSTA)
Packaging type	BOX
Country of origin	DE
GTIN	4050821255161
Customs Tariff No.	85366990990

Subject to changes. Please also observe the further product documentation!

WAGO Kontakttechnik GmbH &amp; Co. KG

Hansastr. 27

32423 Minden

Phone: +49571 887-0 | Fax: +49571 887-169

Email: [info.de@wago.com](mailto:info.de@wago.com) | Web: [www.wago.com](http://www.wago.com)

Do you have any questions about our products?



We are always happy to take your call at +49 (571) 887-44222.

## Approvals / Certificates







### Country specific Approvals

Logo	Approval	Additional Approval Text	Certificate name
	CCA DEKRA Certification B.V.	EN 61535	71-102984

### Ship Approvals

Logo	Approval	Additional Approval Text	Certificate name
	ABS American Bureau of Shipping	Steel Vessel Rules	19-HG1869855-PDA
	DNV GL Det Norske Veritas, Germanischer Lloyd	-	TAE00001Z6



## Counterpart

	<b>Item no.890-104</b> Socket; with strain relief housing; 4-pole; Cod. A; 1,50 mm <sup>2</sup> ; black	<a href="http://www.wago.com/890-104">www.wago.com/890-104</a>
	<b>Item no.890-114</b> Plug; with strain relief housing; 4-pole; 1,50 mm <sup>2</sup> ; black	<a href="http://www.wago.com/890-114">www.wago.com/890-114</a>
	<b>Item no.890-204</b> Socket; 4-pole; Cod. A; 1,50 mm <sup>2</sup> ; black	<a href="http://www.wago.com/890-204">www.wago.com/890-204</a>
	<b>Item no.890-214</b> Plug; 4-pole; 1,50 mm <sup>2</sup> ; black	<a href="http://www.wago.com/890-214">www.wago.com/890-214</a>
	<b>Item no.891-8994/006-101</b> pre-assembled interconnecting cable; Eca; Socket/plug; 4-pole; Cod. A; H05VV-F 4G 1.5 mm <sup>2</sup> ; 1 m; 1,50 mm <sup>2</sup> ; black	<a href="http://www.wago.com/891-8994/006-101">www.wago.com/891-8994/006-101</a>
	<b>Item no.891-8994/106-101</b> pre-assembled connecting cable; Eca; Socket/open-ended; 4-pole; Cod. A; H05VV-F 4G 1.5 mm <sup>2</sup> ; 1 m; 1,50 mm <sup>2</sup> ; black	<a href="http://www.wago.com/891-8994/106-101">www.wago.com/891-8994/106-101</a>
	<b>Item no.891-8994/206-101</b> pre-assembled connecting cable; Eca; Plug/open-ended; 4-pole; Cod. A; H05VV-F 4G 1.5 mm <sup>2</sup> ; 1 m; 1,50 mm <sup>2</sup> ; black	<a href="http://www.wago.com/891-8994/206-101">www.wago.com/891-8994/206-101</a>

Subject to changes. Please also observe the further product documentation!

## Compatible products

### assembling

	<b>Item no.: 890-624</b> Mounting plate; 4-pole; for distribution connectors; Plastic; black	<a href="http://www.wago.com/890-624">www.wago.com/890-624</a>
	<b>Item no.: 890-674</b> Mounting plate; 4-pole; for distribution connectors; Plastic; white	<a href="http://www.wago.com/890-674">www.wago.com/890-674</a>

## Downloads

### Documentation

#### Bid Text

890-945 GAEB X81 - Datei	Feb 19, 2019	xml 2.9 kB	Download
890-945 doc - Datei	Dec 1, 2014	doc 23.0 kB	Download

### CAD/CAE-Data

#### CAD data

2D/3D Models 890-945	URL	Download
----------------------	-----	----------

#### CAE data

WSCAD Universe 890-945	URL	Download
------------------------	-----	----------

## Installation Notes

### Installation

Subject to changes. Please also observe the further product documentation!

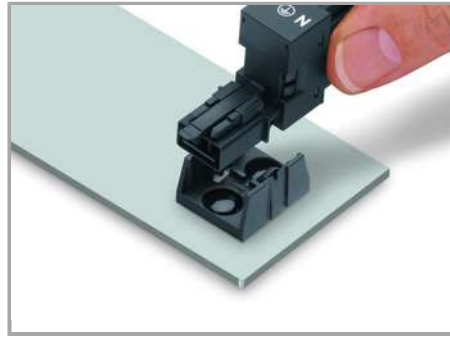

Secure the mounting plate via pins.

## Product family

*WINSTA*® MINI

[Show all products from the family](#)

Subject to changes. Please also observe the further product documentation!