

WAGO Relays and Optocouplers

Application Overview



DIVERSE
ELECTRONICS

1 (800) 381-7308 / (514) 388-7308



sales@diverseelectronics.com
www.diverseelectronics.com



Contents

Features and Advantages	4
Selection Criteria for Relays	6
Long Cables and 2-Wire Sensors	8
Modern Lighting with Electronic Control Gears (ECGs)	10
Functional Safety	12
Use in Potentially Explosive Atmospheres	14
The Contact Material Is Crucial	18
Manually Operated Relays	22
Relays with a Wide Input Voltage Range	24
Rail-Specific Requirements	26
Switching DC Loads	30
Optocouplers and Solid-State Relays	32
Glossary	36
Connection Technologies	39



FEATURES AND ADVANTAGES

Relays/Optocouplers

Relays or Optocouplers?

Relays	Optocouplers/Solid-State Relays
	<ul style="list-style-type: none"> • Electrically isolate input and output circuits • Adjust different signal levels • Amplify and/or multiply signals
Immune to electromagnetic interference and transient voltages	Long service life – no mechanical wear on contacts
High, short-term overload on both input and output sides without losing functionality	High switching frequency due to short switch-on and switch-off times
Minimal switching loss/high switching power	Unfazed by shock and vibration
A single module that switches both direct and alternating currents (highly versatile)	No contact bouncing
No leakage current in the load circuit (air insulation)	"Noiseless" switching
Multiple contacts possible (control signal switches multiple load circuits)	Low control power
Switching state is partially visible to the naked eye	Short response times
Safe isolation between coil and contact set	No electromagnetic radiation from switching sparks or coils – no interference with adjacent modules or electronic components during switching
Read about "Relays" starting on page 6.	Read about "Optocoupler and SSR Modules" starting on page 32.



Distinguishing between Optocouplers and Solid-State Relays

Optocouplers	Solid-State Relays
Mounted or soldered to the PCB - Cannot be replaced	Pluggable on socket - Can be replaced for repairs
A large number of variants enhances application flexibility and range.	Seamless change from electronic to electromechanic switching element

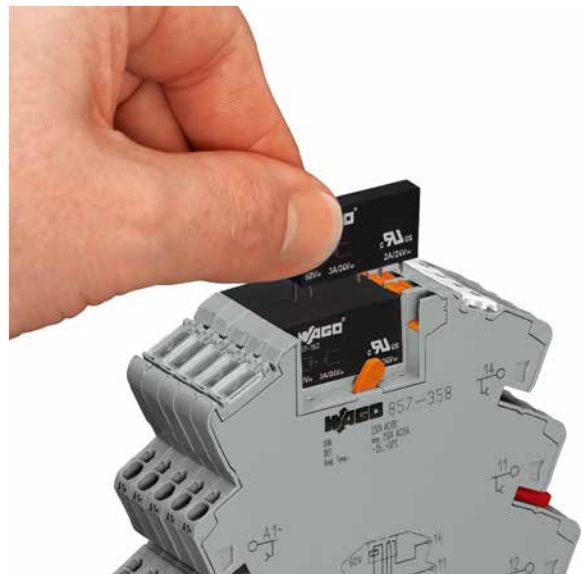

SELECTION CRITERIA FOR RELAYS

It's in the Details

In industrial applications, relays are proven interface modules that can handle a variety of tasks. However, some points must be considered when selecting the right relay module. These points include the nominal voltage of the coil, as well as the number of relay break contacts, make contacts and changeover

contacts. The contacts are important for service life. Selecting the proper contact material depends on whether inductive, capacitive or resistive loads will be connected. This application overview provides important information for selecting relays.



1) Coil: Coil voltage, maximum continuous voltage, response voltage and pick-up current, drop-off voltage and drop-out current



2) Contacts: Contact arrangement, contact loading, contact material, service life, contact resistance, isolation requirements, limiting continuous current



3) Response Time: Response time, drop-out time, switching frequency, bounce time



4) Mechanical Features: Vibration resistance, shock resistance, size and space

5) Other Criteria

Ambient temperature, dielectric strength, mounting conditions, IP degree of protection, approvals



istock.com/Bartosz_Hadyniak

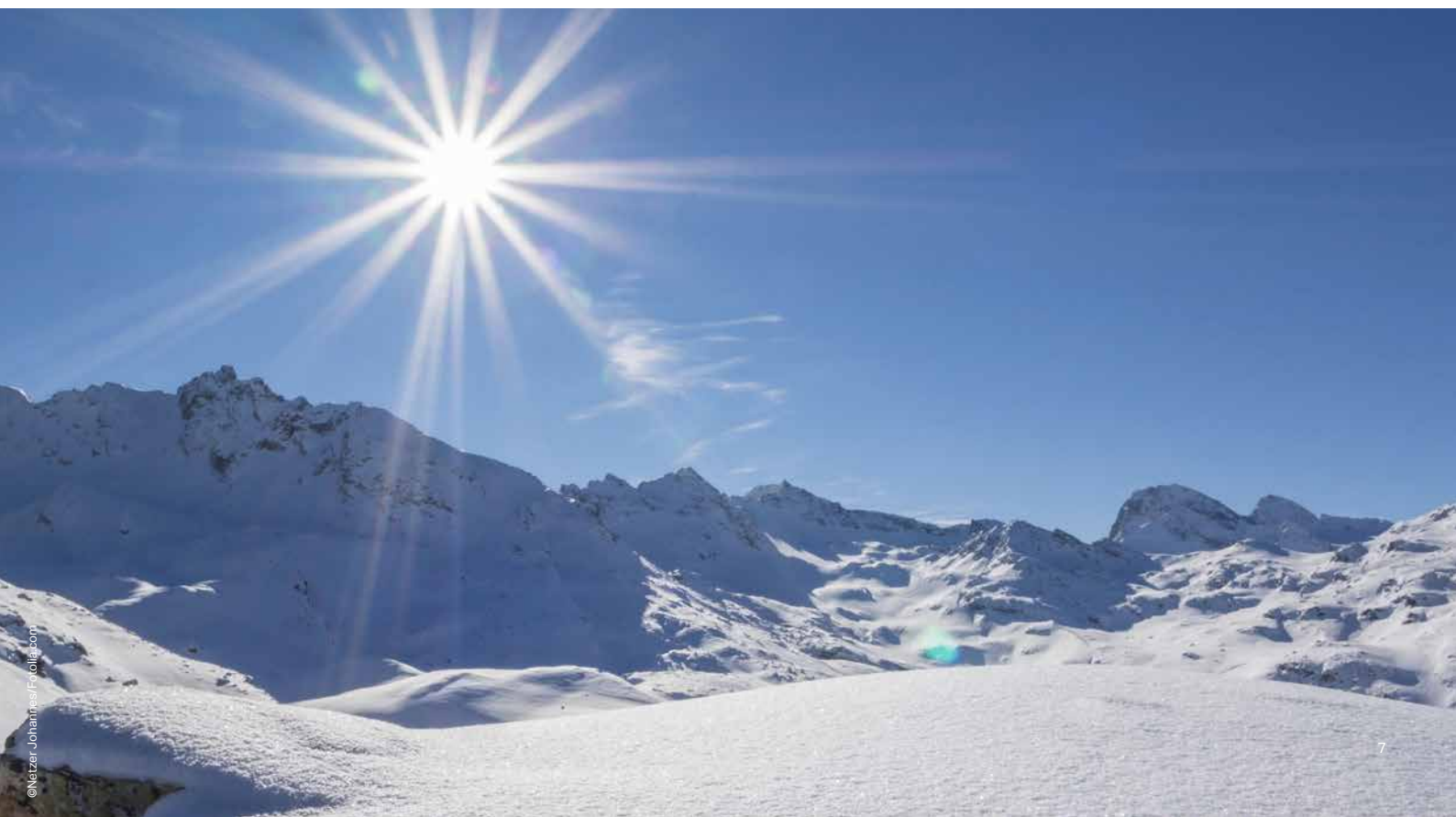

© Neizer Johannes/Fotolia.com

LONG CABLES AND 2-WIRE SENSORS

Reliably Switch Despite Coupling

To switch on, relay modules require the nominal voltage U_N . For operation, however, a holding voltage that's just 15% of the nominal voltage is sufficient. In standard circuits, all relay modules operate reliably. In circuits with long, parallel lines, or those having either active two-wire sensors or digital AC control outputs, however, a low holding voltage often leads to malfunction. The modules no longer switch off. This effect often occurs when updating systems, changing old "power-hungry" to current "power-saving" relay modules. What are the causes and how can they be solved? Long, parallel lines are capacitively coupled to

each other. Energy is then transferred to an adjacent conductor. Active two-wire sensors, such as proximity switches or level monitors, normally require a minimum continuous current to ensure that the holding voltage is maintained on the relay control lines. Because of this behavior, the relay cannot switch correctly. For such applications, WAGO has developed specific RC base load modules against interference coupling and integrated them into the relay modules. The modules minimize the unwanted voltages at low loss and allow defined switching.

Application example:
Triac outputs from
controllers

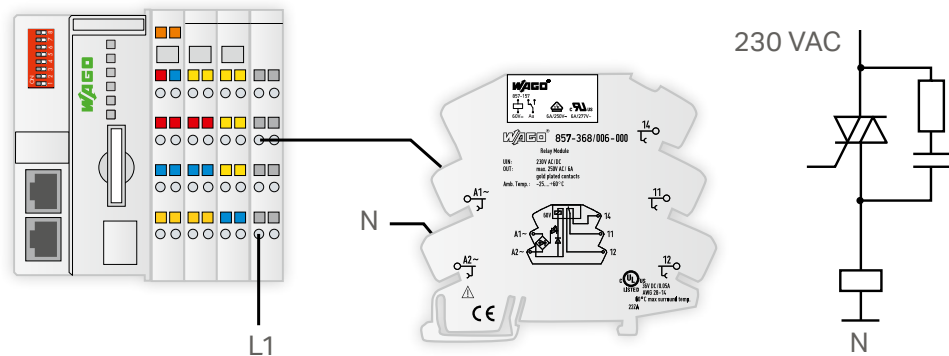

Reliability 24/7: WAGO's sockets that have a miniature switching relay and base load module ensure safety and dependability at voltage levels below an application's release voltage.



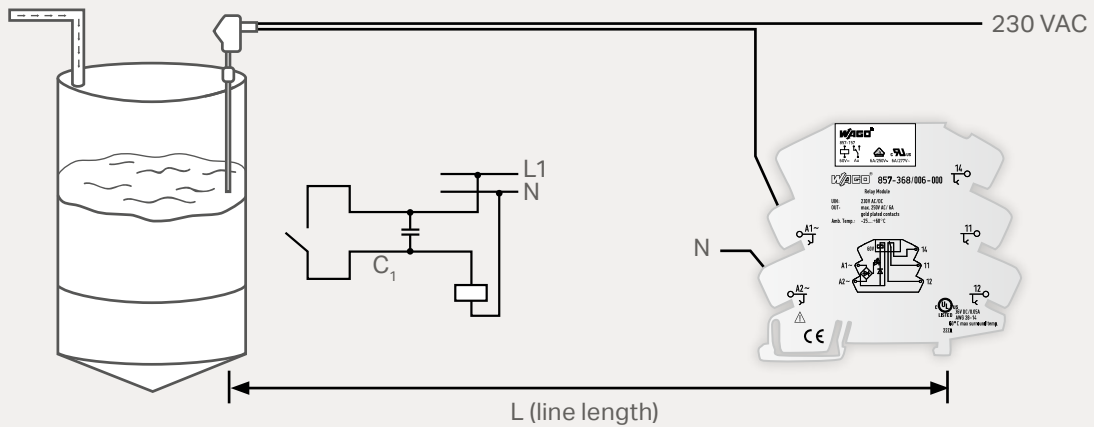

Application example: Line capacity (level measurement)

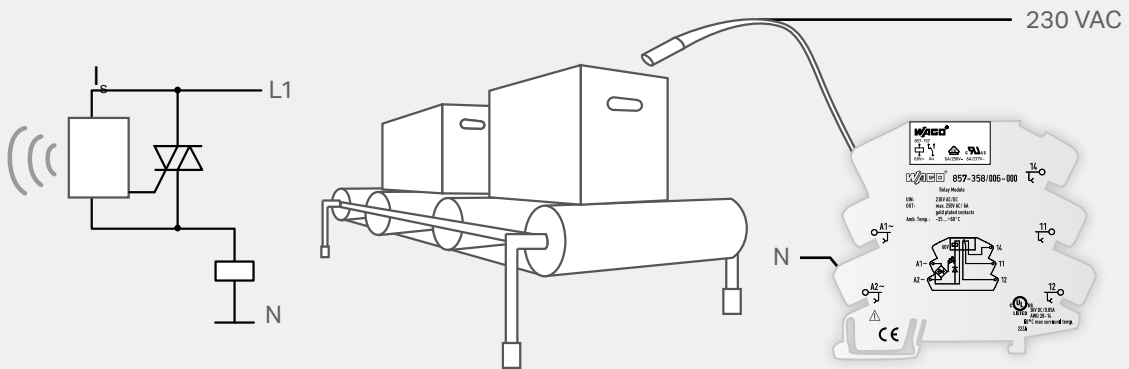

Application example: 2-wire sensors (parcel load detection)

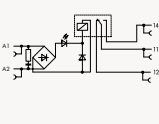

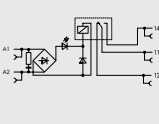
Product	Circuit Diagram	Description	Nominal Input Voltage U_N	Limiting Continuous Current	Item Number
		Relay module with 1 changeover contact, with integrated base load module	230 VAC	6 A	857-358/006-000
		Relay module with 1 changeover contact, with integrated base load module and gold contacts	230 VAC	6 A*	857-368/006-000

*To prevent damaging the gold layer, 30 VDC switching voltages and 50 mA currents must not be exceeded. Higher switching power eventually evaporates the gold layer. The resulting deposits in the housing may reduce service life.

MODERN LIGHTING WITH ELECTRONIC CONTROL GEARS

Brief Current Peaks – Fatal Consequences

When equipped with electronic control gears (ECGs) or LED drivers, modern lighting systems offer numerous advantages. They generate flicker-free light with high levels of efficiency. Both in planning new and replacing old lighting systems, the inrush current of the ECGs must be a central focus. A capacitor in the input circuit of many ECGs and LED drivers causes a substantial current peak when switched on that can well exceed ten times the rated current. Even if the current lasts for just a few milliseconds, it can cause the relay contacts to fuse.

What should be considered when planning lighting systems? When selecting relays, the inrush current must be considered. Standard relays quickly reach their limits. For such applications, WAGO has developed relay modules with contacts that safely control brief high peak inrush currents. The contact material reliably prevents contacts from catching or fusing. For maximum inrush currents, relay modules with two contacts working in parallel are available. The first contact, consisting of high-strength tungsten, catches

the current peak. The second contact, made of highly conductive silver alloy, manages the operational current. As an alternative to relays, the WAGO product portfolio includes optocouplers and solid-state relays for use with capacitive loads. Special designs with zero voltage switches minimize the peaks.

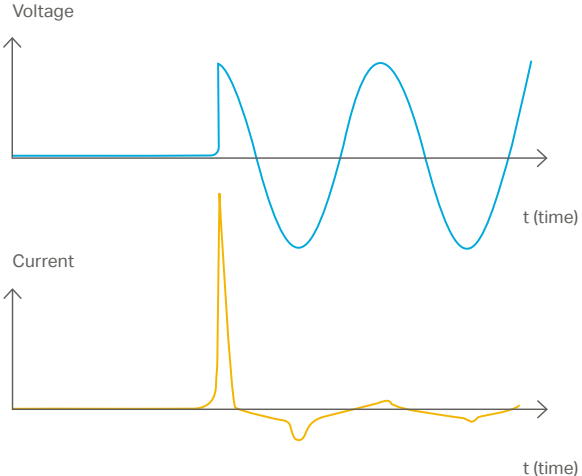



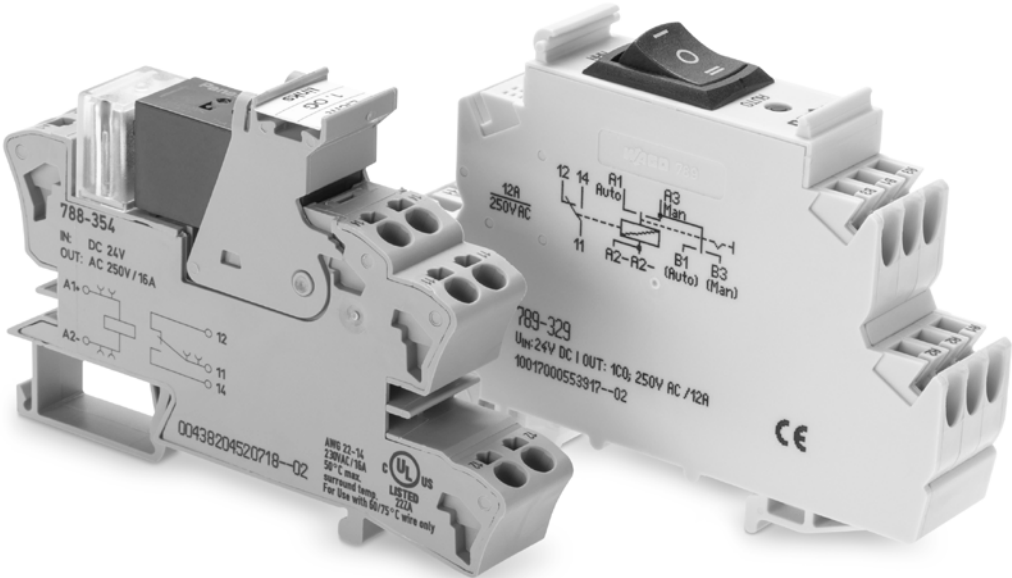



Brief current peaks (transients) when the lights are switched on



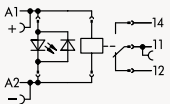

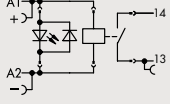
When switching on lamps, substantial current peaks briefly occur. The unwanted effect of wear and contact erosion can be prevented by lamp load relays.

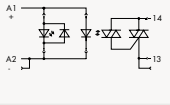
Relays for Lamp Loads

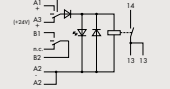
Product	Circuit Diagram	Description	Nominal Input Voltage U_N	Limiting Continuous Current	Item Number
		Relay module with 1 change-over contact and status indication, max. inrush current 120 A / 50 ms	24 VDC	16 A	788-354
		Relay module with 1 make contact and status indication, max. inrush current 165 A / 20 ms	24 VDC	16 A	788-357
		Solid-state relay module, zero voltage switch	24 VDC	3.5 A	788-730
		Relay with 1 make contact, Manual/OFF/Auto switch with feedback contact	24 VDC	16 A	789-324



Signal monitoring: Relays with force-guided contacts make it possible to quickly detect errors such as opening failures.

FUNCTIONAL SAFETY



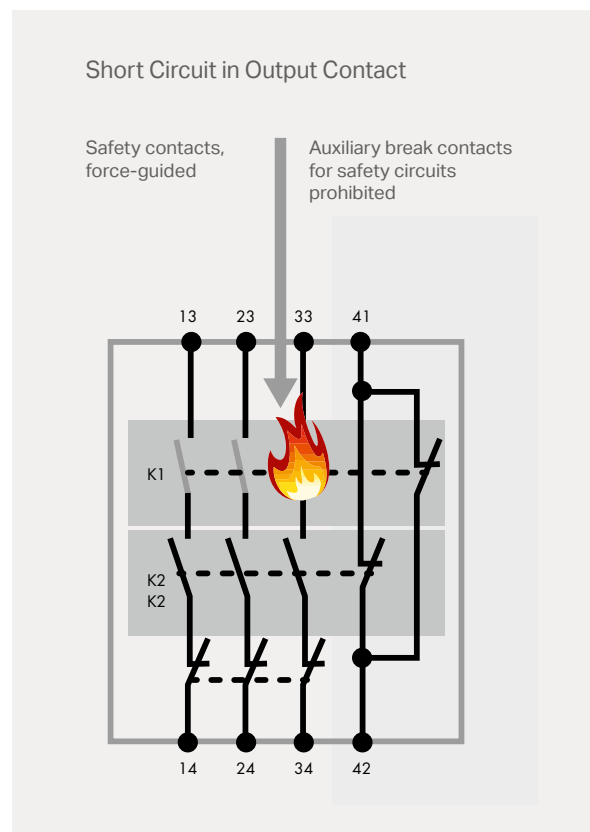

Detect Errors in Safety-Related Circuits

To comply with relevant policies and regulations for functional safety, the use of special components is mandatory. These components must meet strict requirements. For relay modules, force-guided contacts with at least one break contact and make contact are required. They must be connected mechanically so that break contacts and make contacts cannot be closed or opened at the same time. This connection allows errors due to opening failures to be clearly identified. Only errors due to opening and isolation failures are important in safety-related matters.

In a circuit, an open break contact can be detected by a closed break contact. The same applies to a closed make contact when the break contact is open. Of course, EN 50205 requirements also apply to relays with changeover contacts in safety-related circuits. It stipulates that per changeover contact, only the break contact or make contact can be used and the changeover contacts must be positively driven. Therefore, only relays with at least two changeover contacts can be used in safety-related circuits.

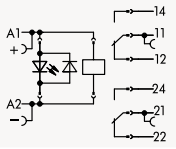

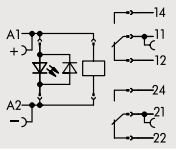
Safety Relays

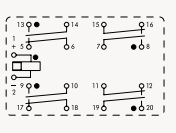
Product	Circuit Diagram	Description	Nominal Input Voltage U_N	Limiting Continuous Current	Item Number
		Safety relay module SR2M (2 changeover contacts) with force-guided contacts (type A) and status indication	24 VDC	6 A	788-384
		Safety relay module (2 changeover contacts) with force-guided gold contacts (type A) and status indication	24 VDC	0.3 A	788-906
		Safety relay module with 4 break contacts and 4 make contacts, relay pre-soldered onto carrier, force-guided contacts, type B	24 VAC/DC	6 A	288-414

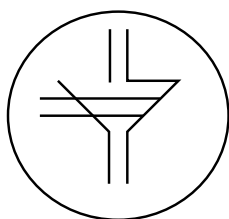

Type A

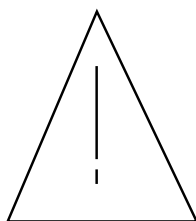

Type B

The EN 50205 standard differentiates between two contact sets by the type of positively driven operation:

Type A: Relays in which all the contacts are mechanically connected

Type B: Relays that have both mechanically connected and non-mechanically connected contacts



USE IN POTENTIALLY EXPLOSIVE ATMOSPHERES

Safety Meets Flexibility

The formation of an explosive atmosphere is required for the existence of a potentially explosive hazard. Such an atmosphere can be produced at any location where flammable gases or liquids are manufactured, processed, transported and/or stored. Potentially explosive areas arise in various applications including the

chemical industry, during the production of crude oil or natural gas, in the food industry or in tank facilities. DIN EN 1127-1 and all other well-known standards rank hazardous areas according to the likelihood of the occurrence of an explosive atmosphere into the following zones:

Hazardous areas due to explosive gases, vapors and mists:

0

Zone 0:

Areas in which an explosive atmosphere is present continuously, for long periods or frequently.

1

Zone 1:

Areas in which hazardous, potentially explosive atmospheres are likely to occur occasionally during normal operation.

2

Zone 2:

Areas in which an explosive atmosphere is likely to occur rarely or for only a short period during normal operation.



More information about explosion prevention is available here:
www.wago.com/global/process-engineering/explosion-protection

Device Identification:

Identifying devices that may be used in potentially explosive areas is mandatory.

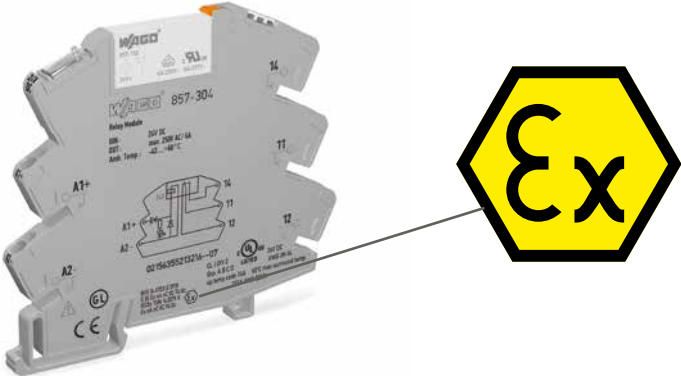



EC Type Examination Certificate









A type examination certificate or manufacturer's declaration is required for use in potentially explosive areas. You can download these from the eShop under www.wago.com and add them to your system documentation.

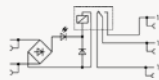

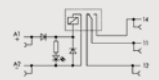
WAGO electromechanical relays and solid-state relays are marked with “nA” type of protection. These markings permit use in Zone 2 explosive atmospheres, thus covering a wide range of applications.

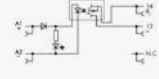
Relays with Ex Approval (Zone 2)

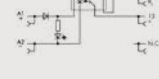
Product	Drawing	Description	Nominal Input Voltage U_N	Limiting Continuous Current	Item Number
		Relay module with 1 changeover contact	230 VDC	6 A	857-358
		Relay module with 1 changeover contact	24 VDC	6 A	857-304
		Solid-state relay module	24 VDC	2 A (0.4 A in Ex applications)	857-724
		Solid-state relay module	24 VDC	0.1 A	857-704

THE CONTACT MATERIAL IS CRUCIAL

Small Circuit Loads – Harsh Environment

Standard relay contacts are normally made of silver alloys such as silver nickel, silver tin oxide or silver cadmium. They are well suited to a variety of applications. However, they are limited to small loads, currents and voltages. The surfaces of the silver alloys are prone to oxidation, which leads to increased contact resistance. It is not a problem when switching larger loads because ever smaller cleaning electric arcs result. That is not the case for smaller loads. There is not enough energy to break up and clean the oxide

layer thermally. This results in malfunctions that can be prevented by using hard gold-plated contacts. Gold does not form an oxide layer and is also very resistant against corrosion in adverse conditions.

WAGO has added a relay version with hard, gold plating to its relay portfolio for switching small loads. Developed for such applications, these new relays guarantee reliable signal transmission over a long period.

Prevent malfunctions: Relays with hard, gold-plated contacts are particularly well suited for switching small loads.



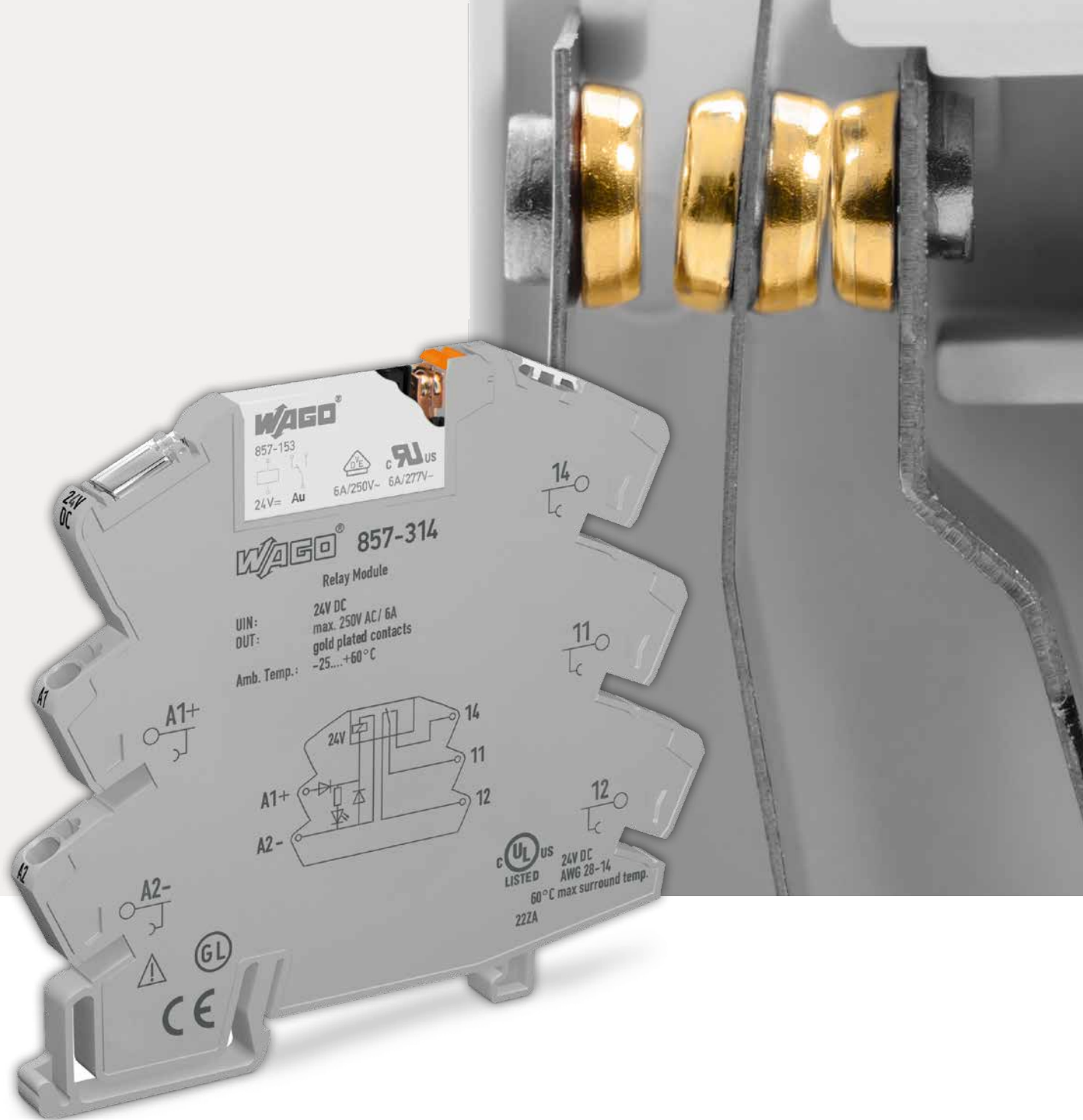

Contact Material	Application Range
AgNi – silver-nickel contact	Resistance loads Weak inductive loads For normal or higher power
AgSnO ₂ – silver tin oxide contact	For high switching loads, primarily in supply voltage applications with high inrush currents Very low tendency to fuse, good burn-off resistance Low material migration when switching from DC
AgCdO – silver cadmium contact	Inductive AC loads For high switching loads, primarily in supply voltage applications Low tendency to fuse, good burn-off resistance
AgNi + Au – silver-nickel contact with hard gold plating	Small load range Very corrosion resistant; important material for reliable contact at low switching capacities



@tuastockphoto/Fotolia.com







In chemical plants, sewage plants or in steel production, aggressive gases must always be accounted for: Relays with gold contacts protect against oxidation and corrosion.

In some sectors of industry, like chemical plants and steelworks, as well as in sewage plants, aggressive gasses are common. Higher pollution levels, as well as high humidity and high temperatures negatively impact electrical components. Relay modules with contacts made of silver alloys are not the first choice. The contact surfaces oxidize preventing switching operations from applying enough energy to reliably break up the oxide layer thermally. Malfunctions then result.

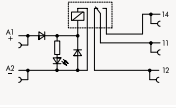
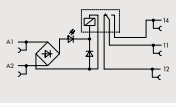
How can malfunctions be prevented?

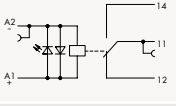
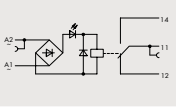
Like switching smaller loads, hard, gold-plated contacts excel in these applications. Relays equipped with gold-plated contacts operate reliably in small load applications up to 50 mA and 30 V. For these jobs, WAGO has specifically developed a relay variant that ensures reliable operation.

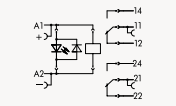
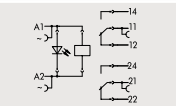
Relays with Gold Contacts

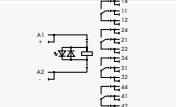
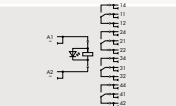
Product	Circuit Diagram	Description	Input Nominal Voltage U_N	Limiting Continuous Current	Item Number
		Relay module with 1 changeover contact, with gold contacts, for normal switching	24 VDC	6 A*	857-314
			230 VAC/DC	6 A*	857-368
		Relay module with 1 changeover contact, with gold contacts, for normal switching	24 VDC	6 A*	857-314
			230 VAC	6 A*	859-359
		Relay module with 2 changeover contacts, gold contacts and status indication	24 VDC	6 A*	857-314
			230 VAC	6 A*	788-616
		Industrial relay module, 4 changeover contacts with gold contacts	24 VDC	5 A*	858-314
			230 VAC	6 A*	858-518

*To prevent damaging the gold layer, 30 VDC switching voltages and 50 mA currents must not be exceeded. Higher switching power eventually evaporates the gold layer. The resulting deposits in the housing may reduce service life.

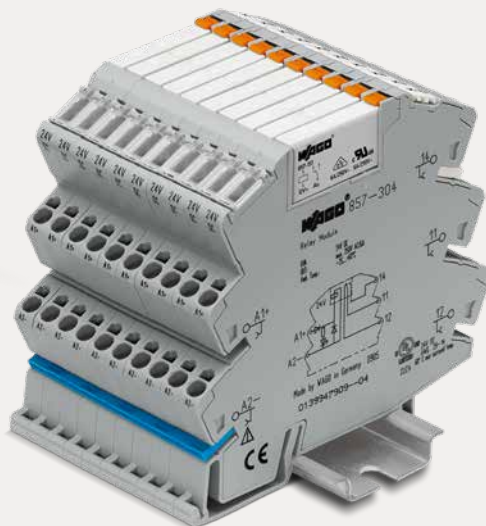

MANUALLY OPERATED RELAYS

Switch Manually and Electrically

Switching individual circuits specifically without actuating the controller is incredibly beneficial for a number of applications, e.g., at startup. For complex building control systems, individual building systems can be checked and commissioned independently of the controller setup. The same applies to commissioning in industrial processes. When troubleshooting, or ensuring unlimited manual operation, service and maintenance personnel appreciate the option of manual operation.

Mechanical or Electrical Manual Operation
WAGO offers two alternatives for relay modules with manual operation. Version one is designed for front panel manual operation, i.e., the contacts are only closed manually. In manual operation, the modules are limited to approximately one hundred switching operations. In automatic mode, these modules complete the usual switching operations of the relay. With the second version with manual operation, the relay coil is electrically connected. The operating status can be set via Manual/OFF/Auto switch on the front panel. The relay modules complete typical relay switching operations with no limitations.

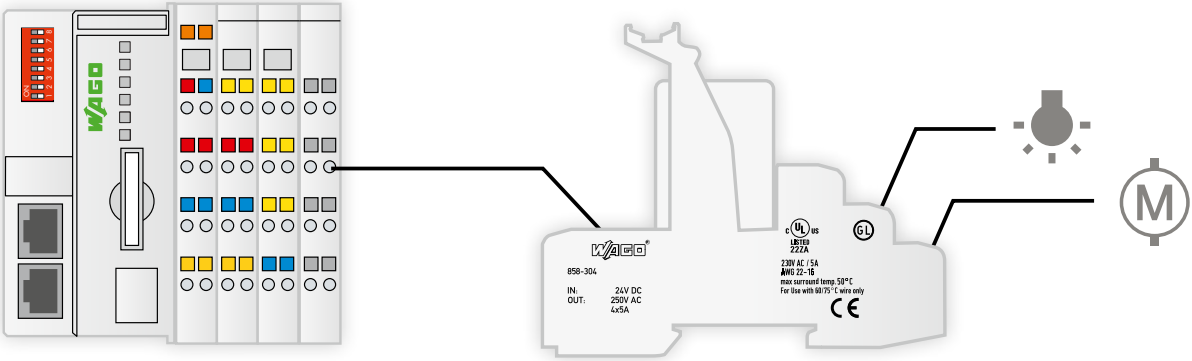





Application example: Building automation

Incredible practicality for building automation and process control: Increased system uptime in the event of a controller failure thanks to a relay with manual operation.

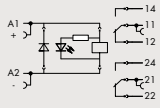

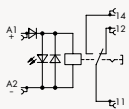
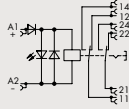
Manually Operated Relays

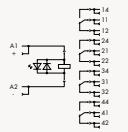
Product	Circuit Diagram	Description	Nominal Input Voltage U_N	Limiting Continuous Current	Item Number
		Relay module with 1 changeover contact, electrical and mechanical status indication, manual operation	24 VDC	16 A	788-341
		Relay module with 2 changeover contacts, electrical and mechanical status indication, manual operation	24 VDC	8 A	788-346
		Relay module with 1 changeover contact, manual operation for manual start-up, electrical and mechanical status indication	24 VDC	12 A	789-1341
		Relay module with 2 changeover contacts, manual operation for manual start-up, electrical and mechanical status indication	24 VDC	8 A	789-1346
		Industrial relay module, 4 changeover contacts, manual operation for manual start-up, electrical and mechanical status indication	24 VDC	5 A	858-304
		Industrial relay module, 2 changeover contacts, manual operation for manual start-up, electrical and mechanical status indication	24 VDC	12 A	858-324

Relays with a Manual/OFF/Auto Switch

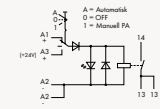
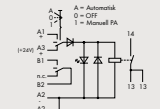
Product	Drawing	Description	Nominal Input Voltage U_N	Limiting Continuous Current	Item Number
		Lamp load relay module with 1 make contact, Manual/OFF/Auto switch	24 VDC	16 A	789-323
		Lamp load relay module with 1 make contact, Manual/OFF/Auto switch with feedback contact	24 VDC	16 A	789-325

RELAYS WITH A WIDE INPUT VOLTAGE RANGE

Versatile

In principle, relay modules with a wide input voltage range are well-rounded, making them perfect for virtually any application. Like the WAGO standard relay modules, they comply with all relevant standards and regulations. These relay modules are designed for DC and AC voltages from 24 V to 230 V, can connect limiting continuous currents up to 6 A and have the same number of switching cycles as the standard versions. They are recommended for many applications, e.g., service and maintenance. Technicians and maintenance specialists need only one relay module for all voltages that is immediately accessible when re-

placing a defective module. Storing a comprehensive inventory of relay modules for various voltage ranges is no longer necessary.

The “one module for every application” principle also optimizes production and storage for manufacturers with small production runs that are exported internationally. Conveniently, they only need one relay module to be their global standard. For ease of use and reliable electrical connections, WAGO equips the relay modules with push-in CAGE CLAMP® connection technology.

Storage and maintenance costs can also be significantly reduced because one single module covers nearly all standard voltage ranges.

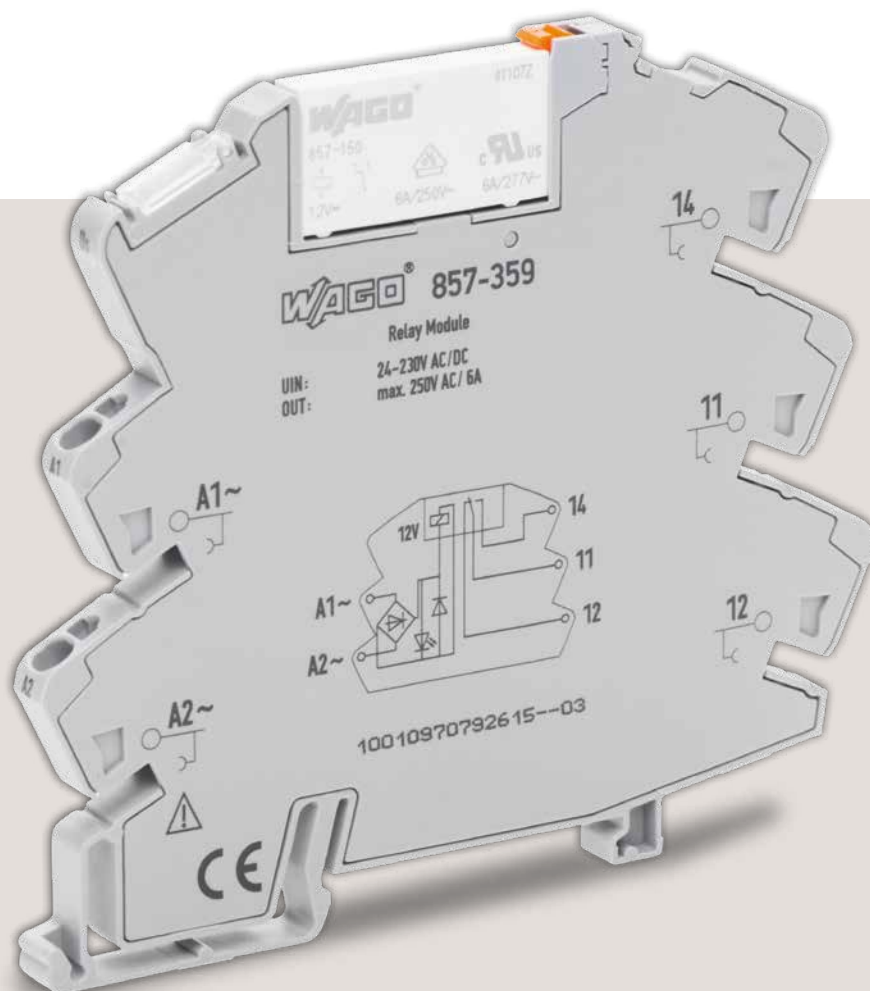

Relays with a Wide Input Voltage Range

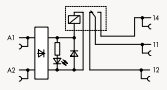
Product	Circuit Diagram	Description	Nominal Input Voltage U_N	Limiting Continuous Current	Item Number
		Relay module with 1 changeover contact, for normal switching	24 ... 230 VAC/DC	6 A	857-359
		Relay module with 1 changeover contact, with gold contacts, for normal switching	24 ... 230 VAC/DC	6 A*	857-369

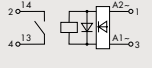
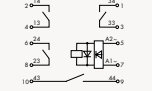
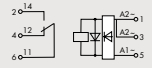
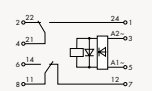
Product	Circuit Diagram	Nominal Input Voltage U_N	Input Voltage Range	Switching Voltage	Limiting Continuous Current	Item Number
		24 ... 230 VAC/DC	$\pm 10\%$	250 VAC	3 A	2042-3809
		24 ... 230 VAC/DC	$\pm 10\%$	250 VAC	3 A	2042-3829
		24 ... 230 VAC/DC	$\pm 10\%$	250 VAC	4 A	2042-3839
		24 ... 230 VAC/DC	$\pm 10\%$	250 VAC	5 A	2042-3849





Within railway applications, there are special requirements for relays including operating voltage, ambient temperature and shock/vibration resistance: WAGO Relays meet these requirements.

RAIL-SPECIFIC REQUIREMENTS







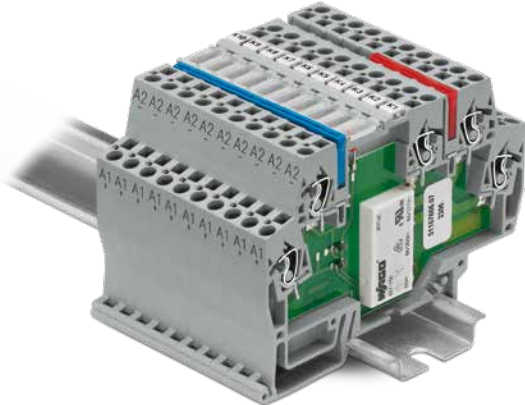

Master Voltage Fluctuations

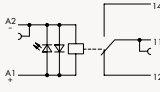
Railway systems have two main application areas: First, there are the mounted installations in signal boxes, turnout systems and access systems. Then there are rail vehicle installations. Behind these railway applications stands EN 50155, which differs significantly from traditional industrial standards. All components used in railway applications must operate reliably at voltages between 70% and 125% of the nominal voltage. Brief spikes up to 1.4 times the nominal voltage must not cause any damage. Deviations from these rules only apply to components powered by stabilized voltage

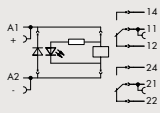

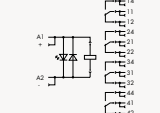
supplies. Fluctuations of $\pm 10\%$ of the nominal voltage are permitted – values common for industrial applications.

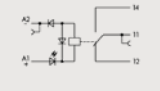

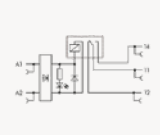
Relays for Railway Systems

Product	Circuit Diagram	Description	Nominal Input Voltage U_N	Limiting Continuous Current	Item Number
		Relay module with 1 changeover contact, with input voltage range of -30 ... +25%	24 VDC	3 A	859-390
		Relay module with 2 changeover contacts, manual operation and extended input voltage/temperature range	24 VDC	3 A	788-390
		Relay module with 4 changeover contacts and extended input voltage/temperature range	24 VDC	5 A	858-354
		Relay module with 1 changeover contact, with $\pm 40\%$ input voltage range	110 VDC	5 A	859-399
		Relay module with 1 changeover contact, for normal switching power	AC/DC 24 ... 230 V	6 A	857-359

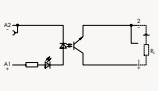
Optocouplers for Railway Systems

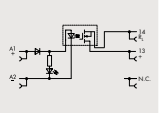
Product	Circuit Diagram	Description	Nominal Input Voltage U_N	Limiting Continuous Current	Item Number
		Optocoupler module with extended input voltage and temperature range, for railway applications	24 VDC	100 mA	859-794
		Socket with solid-state relay module	24 VDC	8 A	857-734

Product	Circuit Diagram	Nominal Input Voltage U_N	Input Voltage Range	Load Switching Voltage Range	Limiting Continuous Current	Item Number
		24 VDC (100 kHz)	16.8 ... 30 VDC	2 ... 32 VDC	0.5 A	2042-7304



FOTO: wago

Relay modules are exposed to extreme temperatures of -40 to $+70^{\circ}\text{C}$ ($-40 \dots 158^{\circ}\text{F}$) in railway applications depending on the area of application. This is because the control cabinet is sometimes installed in a steel housing below the passenger compartment and is not climate controlled. In principle, depending on the place of installation and heat ratio, the railway divides the areas of application for electrical components into four temperature classes, from T1 to TX. Experience has shown that a number of applications fall in class T3, which corresponds to the temperature range of -25°C to $+70^{\circ}\text{C}$ ($-13 \dots 158^{\circ}\text{F}$). All WAGO relay modules for railway applications correspond to the highest classes of T3 or TX.

Loads due to vibration and shock are also significant in railway vehicles. EN 61373 "Railway applications –

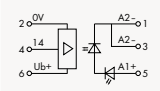
Rolling stock equipment – Shock and vibration tests" describes the mechanical influences in detail caused by operation.

WAGO's relay modules meet all requirements for use in railway operations in categories 1A to 1B. Due to the spring-loaded connection, they also offer high shock and vibration resistance.



Test set-up for mechanical influences during operation

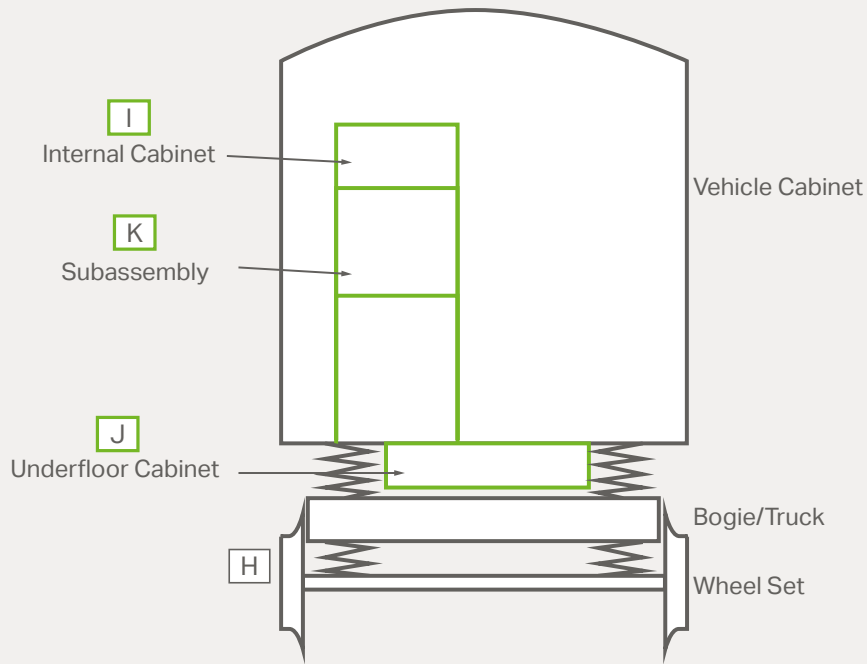

Vibration and Shock: Classification per EN 61373

Category	Item	Description of Device Location
1 Class A	M N O I and J	Components attached directly to or in the vehicle
1 Class B	D	Components installed in an underfloor cabinet that is attached to the vehicle body
1 Class B	K and E	Components installed in a large internal cabinet that is attached to the vehicle body
1 Class B	F	Components as subassemblies that are installed in a cabinet that is attached to the vehicle body
2	G	Cabinets, subassemblies, devices and components attached to the bogie of a railway vehicle
3	H	Cabinets, devices and components or assemblies attached to the wheel set of a railway vehicle

Ambient Operating Temperature per EN 50155

	External Vehicle Ambient Temperature	Internal Cabinet Temperature	Internal Cabinet Overtemperature (< 10 min)	Air Temperature on the PCB
T1	-25 ... +40 °C (-13 ... +104 °F)	-25 ... +55 °C (-13 ... +131 °F)	+15 K	-25 ... +70 °C (-13 ... +158 °F)
T2	-40 ... +35 °C (-40 ... +95 °F)	-40 ... +55 °C (-13 ... +131 °F)	+15 K	-40 ... +70 °C (-13 ... +158 °F)
T3	-25 ... +45 °C (-13 ... +113 °F)	-25 ... +70 °C (-13 ... +158 °F)	+15 K	-25 ... +85 °C (-13 ... +185 °F)
TX	-40 ... +50 °C (-13 ... +122 °F)	-40 ... +70 °C (-13 ... +158 °F)	+15 K	-40 ... +85 °C (-40 ... +185 °F)

SWITCHING DC LOADS

Contacts Connected in Series Improve Load Limit Curve

Applications in DC relays are limited to select areas, which are often battery-backed to increase availability. Such applications include controller instrumentation and control in power plants, chemical systems or railway systems.

Safely switching DC loads requires sophisticated technology. Unlike AC loads, the switching arc is not extinguished automatically with the zero voltage. For DC loads, arc length is largely dependent on the voltages and currents to be switched as the static electric arc limit curve shows. The more pronounced the electric arc, the shorter the relay's service life. If the limit curve is exceeded, the electric arc is no longer extinguished and the relay is destroyed. Structurally, a longer service life can be achieved by increasing the contact distance. However, clear limits are set here by the relay design. A significantly, albeit weakened, effect can be achieved with "series-connected contacts" as the DC load curves show. Because the

contacts are slightly offset in time, the double values are not achieved like for a single contact with double distances.

Static Electric Arc Limit Curve

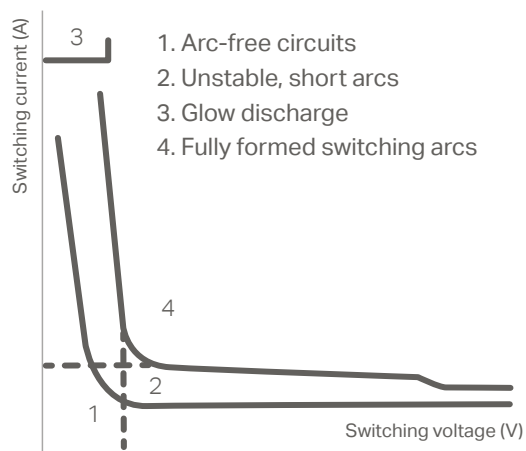

DC load limit curve
788-312

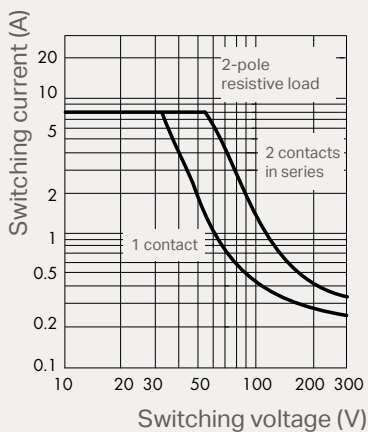

DC load limit curve
858-391

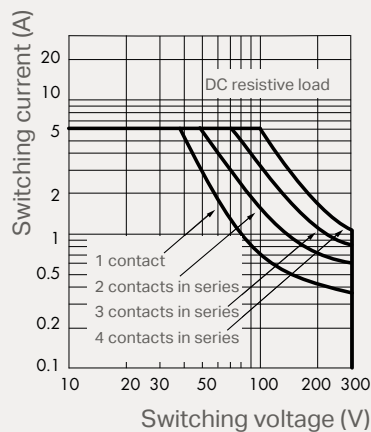



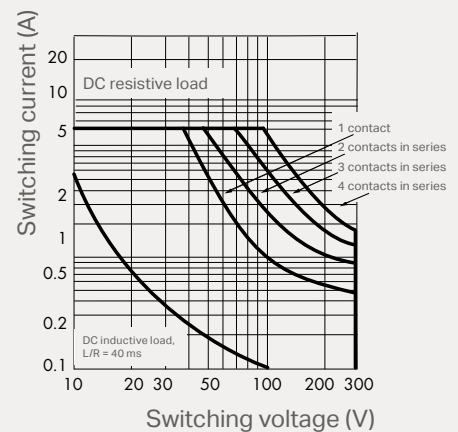

DC load limit curve
858-304, -308



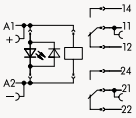

High DC voltages in battery-backed process control systems control:
Relay with contacts connected in series control arcs.

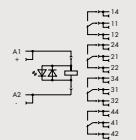
Relays for DC Loads

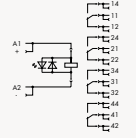
Product	Circuit Diagram	Description	Nominal Input Voltage U_N	Limiting Continuous Current	Item Number
		Relay module with 2 changeover contacts and status indication	24 VDC	8 A	788-312
		Industrial relay module, 4 changeover contacts	24 VDC	5 A	858-304
			220 VDC		858-308
		Industrial relay module, 4 changeover contacts	220 VDC	6 A	858-391

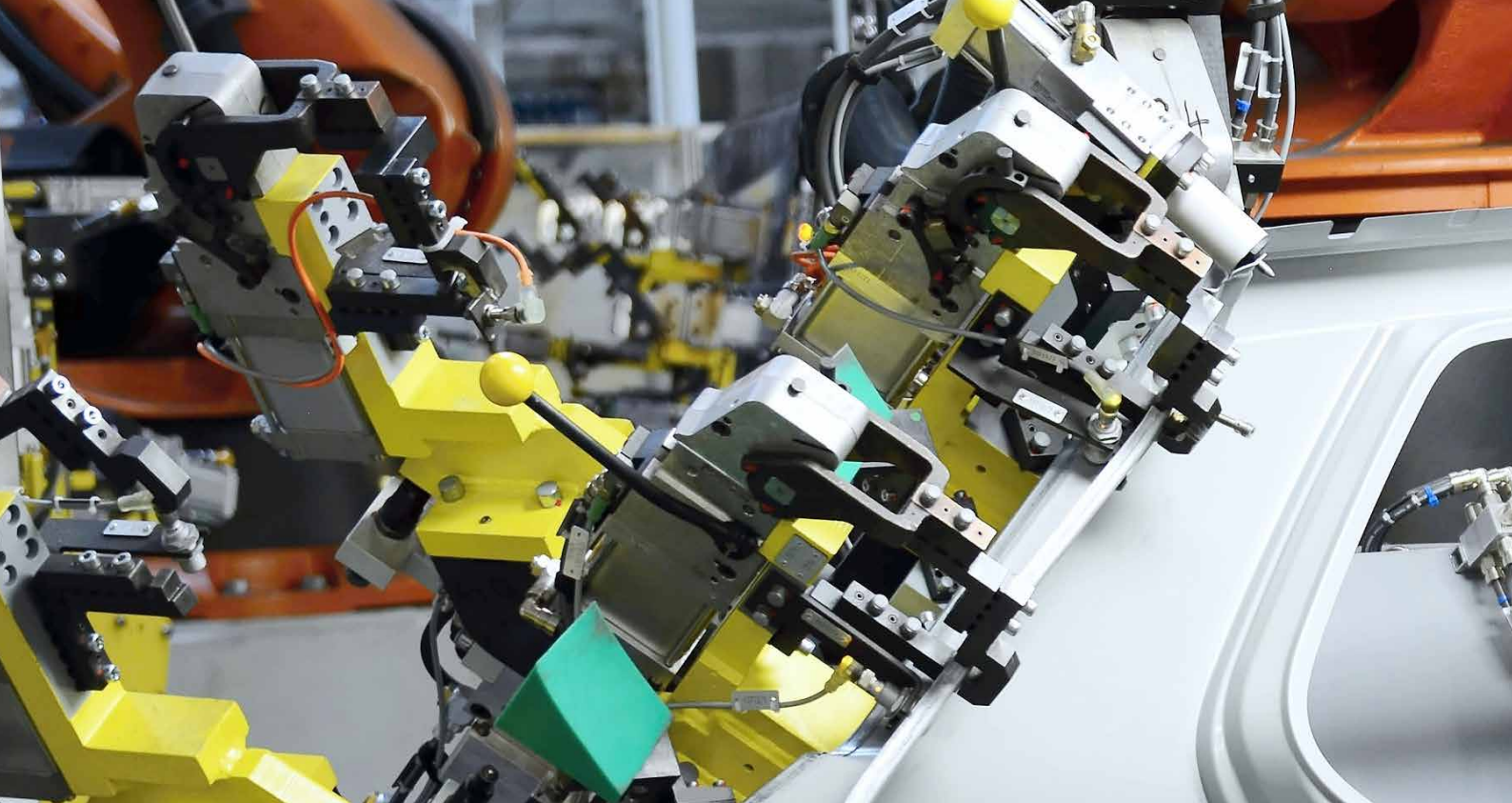

Ideal for production lines: Optocouplers are distinguished by long service lives and short clearing times.

OPTOCOUPPLERS AND SOLID-STATE RELAYS

Durable and Wear-Free

WAGO has developed a wide range of optocoupler and SSR modules for industrial applications. The optocouplers are directly integrated into the housing for all WAGO optocoupler modules. SSR modules are interchangeable solid-state relays that are PIN compatible with all standard relays.

There is an extensive portfolio with versions for both DC and AC voltages. They are designed for the nominal input voltage range of 5 V to 230 V and nominal output voltage range of 3 V to 280 V. The integrated protective circuit ensures sound operation in all applications. The modules switch loads with inrush and switch-off currents equally. These include incandescent bulbs with resistive load and ECGs with capacitive load (originators of high inrush currents), as well as magnet valves with their inductive coils (originators of burdening switch-off currents).







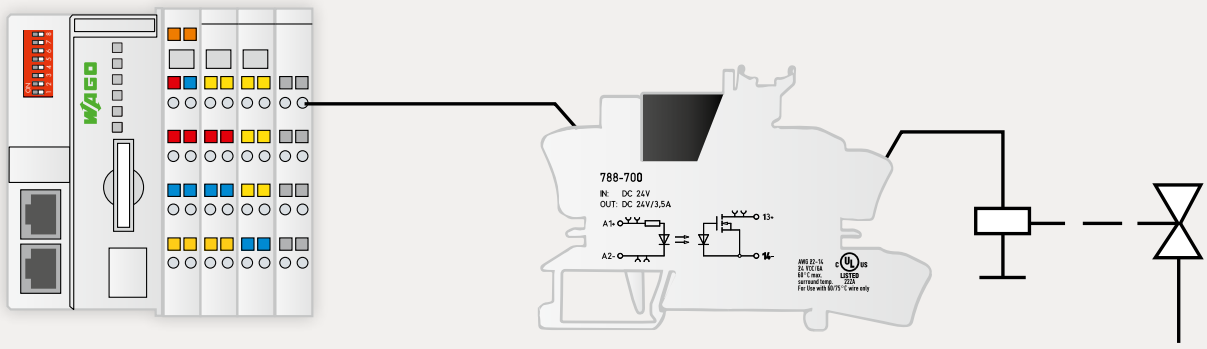
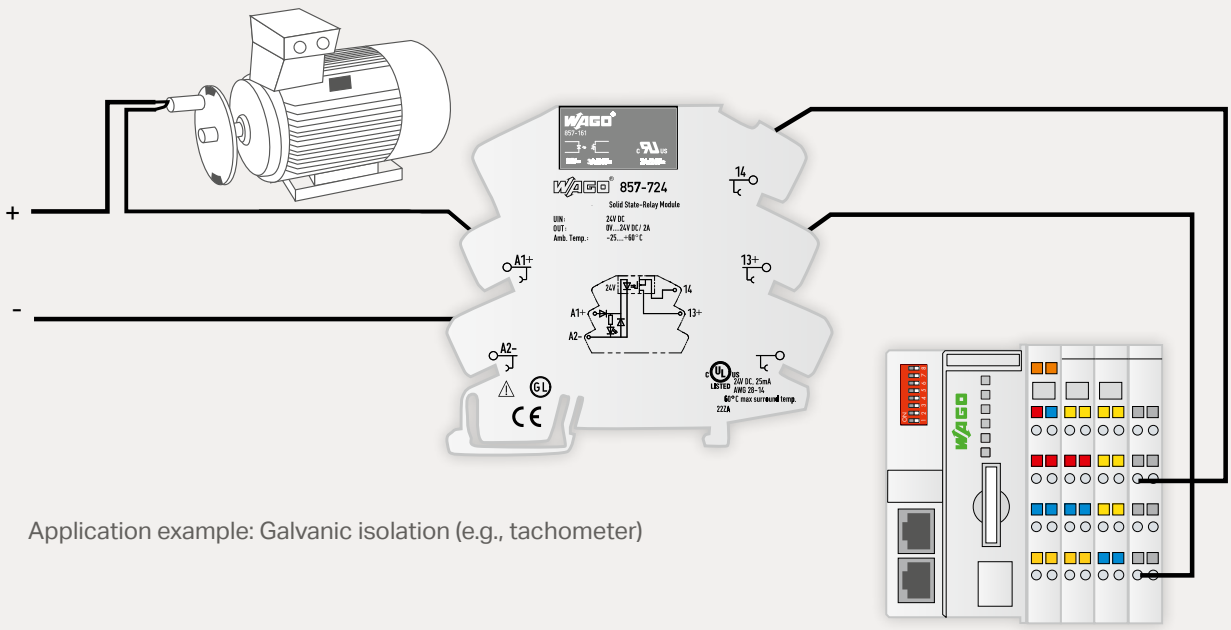



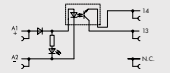

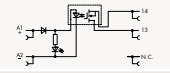

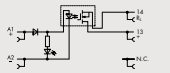

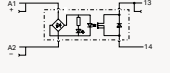
For areas of application with high switching peaks, WAGO has developed optocouplers and solid-state relays with a zero voltage switch. These minimize peaks.

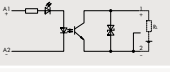
As an interface module between process peripherals, as well as control and signaling equipment, optocouplers and solid-state relays (SSR) impress with the following advantages:

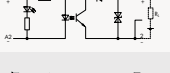

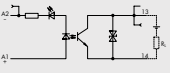

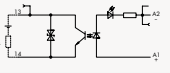

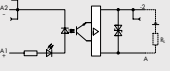
- Long service life
- No mechanical wear
- No contact bouncing
- Short clearing times
- Low inrush current
- Silent operation
- Shock- and vibration-resistance

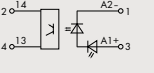

Selection for DC Load, 2-Wire Connection

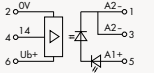
Product	Circuit Diagram	Description	Nominal Input Voltage U_N	Output Voltage Range	Limiting Continuous Current	Item Number
		Solid-state relay module	24 VDC	0 ... 48 VDC	0.1 A	857-704
		Solid-state relay module	24 VDC	0 ... 24 VDC	3 A	857-724
		Socket with Solid-state relay module	24 VDC	1 ... 30 VDC	8 A	857-734
		Socket with Solid-state relay module	24 VDC	0 ... 35 VDC	5 A	788-710
		Optocoupler module	24 VDC	3 ... 30 VDC	100 mA	859-796
		Optocoupler module	5 VDC	3 ... 30 VDC	100 mA	859-795
		Power optocoupler module	24 VDC	3 ... 30 VDC	3 A	859-761
		Power optocoupler module	24 VDC	3 ... 30 VDC	3 A	859-762
		Power optocoupler module	48 VDC	3 ... 53 VDC	4 A	859-744

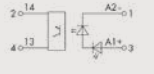
Solid-State Relay Modules

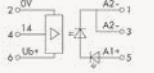
Product	Circuit Diagram	Nominal Input Voltage U_N	Input Voltage Range	Load Switching Voltage Range	Limiting Continuous Current	Item Number
		24 VDC (10 kHz)	16.8 ... 30 VDC	0 ... 60 VDC	0.1 A	2042-7204
		24 VDC (100 kHz)	16.8 ... 30 VDC	2 ... 32 VDC	0.5 A	2042-7304
		24 VDC (1 kHz)	10 ... 53 VDC	0 ... 53 VDC	4 A	2042-7504
		24 VDC (5 kHz)	16.8 ... 30 VDC	20 ... 30 VDC	5 A	2042-7604

Selection for DC Load, 3-Wire Connection

Product	Circuit Diagram	Description	Nominal Input Voltage U_N	Output Voltage Range	Limiting Continuous Current	Item Number
		Power optocoupler module, low-side switching	24 VDC	3 ... 30 VDC	3 A	859-720
			5 VDC	20 ... 30 VDC	500 mA	859-702
			24 VDC	20 ... 30 VDC	500 mA	859-708
			24 VDC	4 ... 6.25 VDC	500 mA	859-706
			5 VDC	20 ... 30 VDC	500 mA	859-752
			24 VDC	20 ... 30 VDC	500 mA	859-758
			24 VDC	4 ... 6.25 VDC	500 mA	859-756

Selection for AC Load

Product	Circuit Diagram	Description	Nominal Input Voltage U_N	Output Voltage Range	Limiting Continuous Current	Item Number
		Solid-state relay module	24 VDC	24 ... 240 VAC	2 AAC	857-714
		Solid-state relay module	24 VDC	24 ... 240 VAC	3.5 AAC	788-730

GLOSSARY

Respond

Change in the switching position of a relay from the idle state (e.g., make contacts open) to the working state (e.g., make contacts closed) caused by applying power; this process was formerly called "tightening."

Bistable Relay

Electrical relay that remains in the achieved switching state after switching off the power; to return to the initial state, another suitable state (e.g., triggering the reset coil) is necessary.

Inrush Current

The indication of the maximum inrush current specifies which peak current is allowed when switching on a contact under defined conditions (e.g., voltage, power factor, time response) without the relay malfunctioning. The inrush current can often be much higher.

Electrical Service Life

Number of switching cycles until the relay fails under a specified electrical load and defined operating conditions; the standard service life values usually apply to the maximum permissible resistive load. For smaller switching loads, a much longer service life is expected. For larger switching loads, the service life is greatly reduced.

Electrical Relay

Component that generates sudden predetermined changes to one or more output criteria when certain requirements in the excitation circuit (input circuit) are met.

Electromechanical Relay

Electrical relay in which the electrical current triggers mechanical movements in the excitation circuit that execute the operation in the output circuit.

Freewheel Diodes

Recovery diodes are primarily used to protect against overvoltages that arise when switching off an inductive DC load (electric motor, relay coil) by self-induction. Voltage peaks are limited to the value of the diode forward voltage and overruns diverted via the diode. However, this leads to a delay in the voltage drop and switching operation.

Electrical Isolation

Potential-free isolation between electrical parts; with galvanic isolation, no charge carriers flow from one circuit to another, i.e., there is no electrically conductive connection between circuits. However, the circuits can still exchange electrical power or signals and specifically via magnetic fields through infrared radiation or charge displacement.

Solid-State Relay

Solid-state relay with a switching element that is an electronic component, e.g., transistor, thyristor or triac; solid-state resistors that boast wear-free operation; compared to relays, they have a high switching frequency. Galvanic isolation is achieved by an integrated optocoupler.

Contact Type

The three most important contact types (also called the contact spring set) are make contact, closed contact and changeover contact.

They are abbreviated as follows:

Germany	UK	America
Make contact 1	Make A	SPST-NO (normally open)
Break contact 2	Break B	SPST-NC (normally closed)
Changeover contact 21	Changeover	SPDT

Creepage Distance

Shortest distance between two conductive parts measured along the surface of an insulation material.

Short-Circuit-Protected

Switching off the final stage of a solid-state relay to protect the output circuit against destruction in the event of a short circuit.

Load Category (Solid-State Relay); Load Classification for Solid-State Relays per EN 62314

LC A – Resistive loads or low inductive loads

LC B – Motor loads

LC C – Electrical discharge lamps

LC D – Incandescent lamps

LC E – Transformers

LC F – Capacitive loads

Leakage Current

Current on the load side of an optocoupler that flows in the locked state of the output stage.

Clearance

Shortest air space between two conductive parts.

Mechanical Service Life

Number of switching cycles during which the relay remains functional with current-free switching contacts.

Monostable Relay

Electrical relay that returns to its initial state after switching off the energizing quantity.

Normally Closed Contact

The contact is closed when the relay is in the idle state and open when the relay is in the working state.

Optocouplers

Optocouplers are electronic components with which a load current is switched via control circuit. Unlike electromechanical relays, optocouplers have no mechanical parts prone to wear. In the control circuit,

a light signal is triggered for the switching operation via an LED that in a photosensitive semiconductor receiver causes the closure of an applied load circuit. Sender (LED) and receiver (e.g., phototransistor) are embedded in a light-conductive plastic and surrounded by an opaque envelope that protects against external influences.

Bounce Time

Time from the first to the final closure (or opening) of a contact caused by shock processes of the contact movement; these shock processes are called "contact bouncing."

Drop-Out Time

Time between switching off the coil excitation and the first opening of the make contact or first closing of the break contact.

Switching Inductive Load

For inductive loads mainly present when using coils in the load circuit, the problem arises when switching off. A magnetic field forms from the current flow in the coil that suddenly collapses and generates a high induction voltage. This voltage peak must be short circuited by a diode connected in parallel. However, the time needed leads to a fall delay.

GLOSSARY

Switching Capacitive Load

Capacity loads occur when there is capacitor in the load circuit. This acts like a short circuit when switching on and causes a high inrush current. If the current is not limited, it can destroy the semiconductor.

Switching Resistive Load

Because the amperage in the load circuit and the voltage via the semiconductor behave inversely proportional to each other for resistive loads, there is usually no problem. Maintaining the maximum amperage and voltage levels of the components is sufficient here.

There is a special case when switching incandescent bulbs. Due to the low cold resistance, overcurrents at 10 to 20 times the operating current can arise when switching on. The components must be designed for these potential overloads that correspond to the effect with capacitive load.

Switching Cycle

The response and relapse of a relay as a result of switching on and off the power.

Make Contact

The contact is closed when the relay is in the working state and open when the relay is in the idle state.

Switching Current

Current (AC or DC) that can switch a relay contact on and off.

Degree of Protection; Categories for Elementary Relays per IEC 61810

RT 0: Unenclosed relay

Relay with no protective housing

RT I: Dust-protected relay

Relay provided with a housing to protect its mechanisms from dust

RT II: Flux-proof relay

Relay suitable for automatic soldering without allowing solder fluxes to enter its interior

RT III: Washable relay

Relay suitable for automatic soldering followed by washing to remove flux residues without allowing solder fluxes or washing agents to enter its interior

RT IV: Sealed relay

Relay encapsulated so only ambient atmospheres with time constants $> 2 \times 10^4$ s (IEC 60068-2-17) can penetrate

RT V: Hermetically sealed relay

Relay encapsulated so only ambient atmospheres with time constants $> 2 \times 10^6$ s (IEC 60068-2-17) can penetrate

Changeover Contact

Compound contact consisting of break contact and make contact with a common terminal; if one of the contact circuits is open, the other is closed.

CONNECTION TECHNOLOGIES

PUSH-IN CAGE CLAMP®



This connection technology is included in Series 788, 857 and 858.

CAGE CLAMP®



This connection technology is included in Series 859, 789 and 288.

WAGO Kontakttechnik GmbH & Co. KG

Postfach 2880 · 32385 Minden
Hansastraße 27 · 32423 Minden
info@wago.com
www.wago.com

Headquarters	+49 571/887 - 0
Sales	+49 571/887 - 222
Orders	+49 571/887 - 44 333
Fax	+49 571/887 - 844 169

WAGO is a registered trademark of WAGO Verwaltungsgesellschaft mbH.

“Copyright – WAGO Kontakttechnik GmbH & Co. KG – All rights reserved. The content and structure of the WAGO websites, catalogs, videos and other WAGO media are subject to copyright. Distribution or modification of the contents of these pages and videos is prohibited. Furthermore, the content may neither be copied nor made available to third parties for commercial purposes. Also subject to copyright are the images and videos that were made available to WAGO Kontakttechnik GmbH & Co. KG by third parties.”