

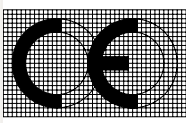





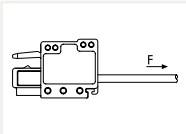

## Technical Section

	Page	
	CE Marking and EC Directives	858
	IEC/EN Specifications	860
	<b>Tests and Testing Procedures per IEC/EN Standards</b>	
	– Mechanical Tests	862
	– Electrical Tests	866
	– Material Tests	879
	– Environmental Tests	880
	<b>UL Specifications – Underwriters Laboratories, USA</b>	882
	– Tests and Testing Procedures per UL Standards	883
	<b>Terminating Aluminum Conductors</b>	887
	<b>Processing Information and Material Specifications</b>	
	– Soldering Information	888
	– Insulation Materials	888
	– Contact Materials, Contact Plating, Clamping Spring Material	890
	<b>General Technical Information on Electrical Equipment Used in Hazardous Areas</b>	891
	– Special Requirements “Increased Safety Ex e”	893
	– Special Requirements “Intrinsic safety Ex i”	896
	<b>International Certification Organizations – Overview</b>	900
	<b>Accredited Test Laboratory</b>	903
	<b>Electrical Engineering Laboratory</b> Product Safety for Our Customers	902
	<b>WAGO Seminars</b> Learn Today – Benefit Tomorrow Benefit from First-Hand Knowledge and Expertise – Training Straight from the Source!	904

## CE Marking and EC Directives

### CE Conformity Marking

The CE conformity marking consists of the characters "CE" with the following script:

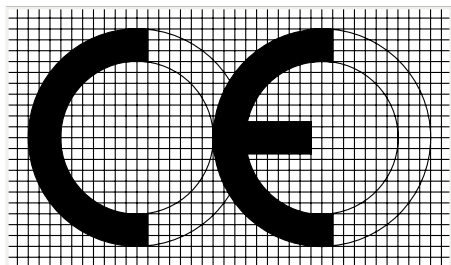

Communauté Européenne  
(European Community)

WAGO Kontakttechnik GmbH & Co. KG products are developed, tested and marked in accordance with legally valid international standards and laws.

The CE mark is applied to products intended for the European domestic market; with it, manufacturers declare that the marked electrical equipment conforms with the applicable requirements set out in the Community harmonization legislation (EU Directives), which allows such equipment to carry this mark.

The original intention of this mark was to support the authorities in the EU member states in their market supervision, with the mark acting as a symbol of free movement of products within the EU. According to EC Directive 765/2008, a product can only be given the CE mark if the product requirements are defined in at least one appropriate EU directive. Examples of such directives are the Low Voltage Directive, the EMC Directive, the ATEX Directive, the Building Products Directive and the Machinery Directive. If more than one directive applies to a product, the product must comply with **all applicable directives**.

Only the basic requirements for achieving the defined aim of the directive are laid out in each respective directive. The individual technical details are specified according to the New Approach using lists with cross references to applicable standards (so-called harmonized standards).

### 1. Low Voltage Directive (LVD)

The safety of electrical equipment is guaranteed by the Low Voltage Directive (LVD). The LVD covers all electrical equipment operating with a voltage between 50 VAC and 1000 VAC and between 75 VDC and 1500 VDC.

Products falling within the scope of the Low Voltage Directive that are designed in such a way that they can be used in other electrical devices, and whose safety, for the most part, is dependant on how these components were built into the end product and what features the end product has, are defined as basic components in accordance with the Low Voltage Directive.

The LVD doesn't apply to basic components.

The RoHS Directive also applies to electrical equipment covered by the Low Voltage Directive. This directive regulates the use of hazardous substances in electrical devices and components, with the aim of reducing the quantity of problematic components in electrical waste. Details about the materials used by WAGO are available in our catalogs, on our product packaging and on our Web page.

### 2. EMC Directive

The EMC Directive stipulates that a product must meet the limits on radiated electromagnetic disturbance and also requires that a product must be immune to electromagnetic interference.

Electromagnetic passive components or components with no direct function, such as terminal blocks, resistors, diodes, capacitors, switching relays or cables (in the form of passive printed circuit boards) are not considered as apparatus within the meaning of the EMC Directive.

### 3. ATEX Directive on Explosion Protection

The ATEX Directive defines the rules for products (devices and protective systems) intended for use in hazardous locations. A number of products from WAGO are designed for use in hazardous areas.

Based on potential hazards, the ATEX Directive makes a distinction between three different equipment groups, of which Group II and III are subdivided into further zones. Suitability of WAGO products for the different groups and zones is outlined in the specific product documents (catalogs, Internet site, data sheets and product inserts).

These may be either devices that can be used as equipment in these types of areas, or components that are required for safe operation, but which do not fulfill a dedicated function. Such components include rail-mount terminal blocks for use in hazardous areas.

Products in both groups must comply with the ATEX Directive.

### 4. Radio Communications Directive

The Radio Communications Directive applies to all devices that properly transmit or receive radio waves for wireless communications and/or radio orientation. The basic safety requirements apply to the protection of health for humans and animals and to electrical safety in line with the Low Voltage Directive, but without the application of the voltage limit. In addition, the EMC protection goals of the EMC Directive must also be fulfilled and efficient use of radio frequencies ensured. WAGO products covered by the Radio Communications Directive indicate, in compliance with applicable laws, only the Radio Communication Directive in their EU Declaration of Conformity, as fulfillment of the Low Voltage Directive and of the EMC Directive is implicit in this declaration.

## 5. Construction Products Regulation

The Construction Products Regulation demands that structures be designed and constructed such that the safety of humans, property and animals is not endangered and that all applicable environmental protection requirements be considered. Here, building products are defined as products or construction sets which are produced to be built permanently into structures and which make a significant contribution to fulfilling the basic requirements for the structure.

In the unanimous opinion expressed by the German electrical industry, including WAGO Kontakttechnik GmbH & Co. KG, products used in general installation technology are not included among these types of building products and are therefore not covered by this directive.

## 6. Machinery Directive

The Machinery Directive applies to machines (complete or incomplete) which perform their functions by means other than direct human or animal work, or safety components for these types of machines.

Therefore, this directive usually does not apply to WAGO products.

The manufacturers of machines or systems are required by this directive to use safe products and components in their machines and systems. Directive-compliant production and safe operation is facilitated by the use of WAGO products, with their standard-compliant, up-to-date design.

## Significance of CE Mark for WAGO Products

One, several or none of the EU Directives may apply to the various WAGO products. If none of the directives apply, the CE marking will not be affixed to the product, in line with applicable laws. Furthermore, a declaration of conformity must not be issued. All other products are provided with the CE mark – either directly on the product, on its packaging or in the documents included with the product – and a declaration of conformity is issued, or made accessible to the customer.

The data sheets of the technically sound products that, according to the regulations, are not CE marked will refer to the standards used in the development and type and manufacturing testing wherever possible.

## IEC/EN Specifications

The following standards apply to the design and application of the terminal blocks and connectors contained in this catalog:

IEC 60364-1 HD 60364-1 VDE 0100-100 / Erection of power installations with nominal voltages up to 1000 V – Part 1: Fundamental principles, assessment of general characteristics, definitions	IEC 60079-7 EN 60079-7 VDE 0170-6 / Explosive atmospheres – Part 7: Equipment protection by increased safety "e"	IEC 61439-3 EN 61439-3 VDE 0660-600-3 /– Low-voltage switchgear assemblies – Part 3: Distribution boards intended to be operated by ordinary persons (DBO)
IEC 61140 EN 61140 VDE 0140-1 / Protection against electric shock – Common aspects for installation and equipment	IEC 60079-11 EN 60079-11 VDE 0170-7 / Harzardous areas – Part 11: Equipment protection by intrinsic safety "i"	IEC 61643-11 EN 61643-11 VDE 0675-6-11 / Low-voltage surge protective devices – Part 11: Surge protective devices connect-ed to low-voltage power systems – Requirements and test methods
IEC 60364-7-710 HD 60364-7-710 VDE 0100-710 – Part 7-710: Requirements for special instal-lations or locations – Medically used areas	IEC 60079-14 EN 60079-14 VDE 0165-1 / Harzardous areas – Part 14: Electrical installations design, se-lection and erection	IEC 60335-1 EN 60335-1 VDE 0700-1 / Safety of household and similar electrical appliances – Part 1: General requirements
IEC 60364-7-718 HD 60364-7-718 VDE 0100-718 – Part 7-718: Requirements for special instal-lations or locations – Communal facilities and workplaces	IEC 60079-15 EN 60079-15 VDE 0170-16 / Explosive atmospheres – Part 15: Equipment protection by type of protection "n"	IEC 60598-1 EN 60598-1 VDE 0711-1 / Lighting fixtures – Part 1: General requirements and tests
EN 50110-1 VDE 0105-1 / Operation of electrical installations – Part 1: General requirements	IEC 60038 EN 60038 VDE 0175-1 / IEC CENELEC standard voltages	IEC 60715 EN 60715 /– Standardized mounting on rails for me-chanical support of electrical devices in switchgear and control-gear installations
IEC 60664-1 EN 60664-1 VDE 0110-1 / Insulation coordination for equipment within low-voltage systems – Part 1: Principles, requirements and tests	VDE 0298-4 / Use of cables and insulated conductors in power installations – Part 4: Recommended values for current carrying capacities of cables for fixed instal-lation and for flexible cables	IEC 60999-1 EN 60999-1 VDE 0609-1 / Connecting devices – Electrical copper conductors – Safety requirements for screw-type and screwless-type clamping units – Part 1: General requirements and particular requirements for clamping units for conduc-tors from 0.2 mm <sup>2</sup> up to 35 mm <sup>2</sup>
IEC 60204-1 EN 60204-1 VDE 0113-1 / Safety of machinery – Electrical equipment of machines – Part 1: General requirements	IEC 60112 EN 60112 VDE 0303-1 / Method for determining the comparative and the proof tracking indices of solid insula-tion materials	IEC 60999-2 EN 60999-2 VDE 0609-101 – Part 2: General requirements and particular requirements for clamping units for conduc-tors from 35 mm <sup>2</sup> up to 300 mm <sup>2</sup>
IEC 60079-0 EN 60079-0 VDE 0170-1 / Harzardous areas Part 0: Equipment – General requirements	IEC 60529 EN 60529 VDE 0470-1 / Degrees of protection provided by enclo-sures (IP Code) – Testing equipment and testing method	
	IEC 61439-1 EN 61439-1 VDE 0660-600-1 / Low-voltage switchgear and control-gear assemblies – Part 1: General rules	

IEC 60998-1 EN 60998-1 VDE 0613-1 / Connecting devices for low-voltage circuits for household and similar purposes – Part 1: General requirements	IEC 60947-7-4 EN 60947-7-4 VDE 0611-4 – Part 7-4: Ancillary equipment – PCB terminal blocks for copper conductors	IEC 60352-5 EN 60352-5 – Part 5: Press-in connections – General requirements Test methods and practical guidance
IEC 60998-2-1 EN 60998-2-1 VDE 0613-2-1 – Part 2-1: Particular requirements for connecting devices as separate entities with screw-type clamping units	IEC 61984 EN 61984 VDE 0627 / Connectors – Safety requirements and tests	IEC 60352-6 EN 60352-6 – Part 6: Insulation piercing connections – General requirements Test methods and practical guidance
IEC 60998-2-2 EN 60998-2-2 VDE 0613-2-2 – Part 2-2: Particular requirements for connecting devices as separate entities with screwless-type clamping units	IEC 60512-1 EN 60512-1 / Connectors for electronic equipment Equipment – Measurement and test procedures – Part 1: General	IEC 60352-7 EN 60352-7 – Part 7: Spring clamp connections – General requirements Test methods and practical guidance
IEC 60998-2-3 EN 60998-2-3 VDE 0613-2-3 – Part 2-3: Particular requirements for connecting devices as separate entities with insulation-piercing clamping units	IEC 60320-1 EN 60320-1 VDE 0625-1 / Appliance couplers for household and similar general purposes – Part 1: General requirements	
IEC 60947-1 EN 60947-1 VDE 0660-100 / Low-voltage switchgear and controlgear – Part 1: General rules	IEC 60352-1 EN 60352-1 / Solderless connections; – Part 1: Wrapped connections – General requirements Test methods and practical guidance	
IEC 60947-7-1 EN 60947-7-1 VDE 0611-1 – Part 7-1: Ancillary equipment Terminal blocks for copper conductors	IEC 60352-2 EN 60352-2 / Solderless connections; – Part 2: Crimped connections – General requirements Test methods and practical guidance	
IEC 60947-7-2 EN 60947-7-2 VDE 0611-3 – Part 7-2: Ancillary equipment Ground conductor terminal blocks for copper conductors	IEC 60352-3 EN 60352-3 – Part 3: Solderless accessible insulation displacement connections – General requirements Test methods and practical guidance	
IEC 60947-7-3 EN 60947-7-3 VDE 0611-6 – Part 7-3: Ancillary equipment Safety requirements for fuse terminal blocks	IEC 60352-4 EN 60352-4 – Part 4: Solderless non-accessible insulation displacement connections – General requirements Test methods and practical guidance	

## Tests and Testing Procedures per IEC/EN Standards

Products such as connecting devices, rail-mount terminal blocks and connectors, etc., have their own product-specific test specifications. The following sections describe the most important tests and are limited to a description of the test procedures and an explanation of the test purpose. The data shown (e.g., voltages, temperatures, forces) only serve as illustration and may differ depending on the test.

### Mechanical Tests

All WAGO products meet requirements for the following mechanical tests:

#### • Termination Requirements

##### Conductor Termination

Two WAGO connection systems are proven in the field of Spring Pressure Connection Technology:

The **PUSH WIRE® connection** for applications requiring solid conductors (e.g., for lighting and building wiring, telecommunications, house communication or alarm systems).

Conductor range:

0.2 ... 4 mm<sup>2</sup> / 24 ... 12 AWG

The **universal CAGE CLAMP® spring pressure connection system** for solid, stranded and fine-stranded conductors, designed for a variety of industrial, electrical and electronic applications (e.g., fine-stranded conductors in the elevator industry, in power stations, in the chemical and automotive industry, and aboard ships).

Conductor range:

0.08 ... 35 mm<sup>2</sup> (28 ... 2 AWG)

The **Push-in CAGE CLAMP® connection** takes universal CAGE CLAMP® connections further by allowing the termination of 0.2 ... 16 mm<sup>2</sup> (24 ... 6 AWG) solid, stranded and fine-stranded conductors (25 mm<sup>2</sup>/4 AWG only "f-st") and offering all the benefits and safety of the original CAGE CLAMP®. Furthermore, the Push-in CAGE CLAMP® connection technology allows solid, stranded and fine-stranded conductors with ferrules from 0.5 to 16 mm<sup>2</sup> (20 ... 6 AWG) to be terminated by simply pushing them in.

The conductor entry hole is perfectly suited for the insulation diameter of the rated conductor cross section, thus providing good conductor guidance.

This is particularly important for vibration-prone applications.

Fine-stranded conductors of small or very small size are highly flexible, and deform when pushed against the conductor stop in terminal blocks. As a result, the conductor insulation – not the copper conductor – may be clamped, causing intermittent contact or no contact at all.

In order to prevent conductor insulation from being inserted into the clamp, insulation stops are available for WAGO rail-mount terminal blocks up to 4 mm<sup>2</sup> (12 AWG), even providing protection for 0.08 mm<sup>2</sup> (28 AWG) conductors (see Section 5).

### Rated Cross Sections and Connectable Conductors

I. Per IEC 60999-1 / EN 60999-1 / VDE 0609-1, Table 1:

Rated Cross Section	Theoretical Largest Conductor Diameter							Connectable Conductor	
	Metric			AWG				Rigid	Flexible
	Rigid		Flexible	Rigid		Flexible			
	Solid	Stranded			<sup>b)</sup> Solid	<sup>b)</sup> Class B Stranded	<sup>c)</sup> Class I, K, M Stranded		
mm <sup>2</sup>	mm	mm	mm	Conductor Size	mm	mm	mm		
0.2	0.51	0.53	0.61	24	0.54	0.61	0.64		
0.34	0.63	0.66	0.8	22	0.68	0.71	0.8		
0.5	0.9	1.1	1.1	20	0.85	0.97	1.02		
0.75	1	1.2	1.3	18	1.07	1.23	1.28		
1	1.2	1.4	1.5	–	–	–	–		To be defined in the corresponding product standard
1.5	1.5	1.7	1.8	16	1.35	1.55	1.6		
2.5	1.9	2.2	2.3 <sup>a)</sup>	14	1.71	1.95	2.08		
4	2.4	2.7	2.9 <sup>a)</sup>	12	2.15	2.45	2.7		
6	2.9	3.3	3.9 <sup>a)</sup>	10	2.72	3.09	3.36		
10	3.7	4.2	5.1	8	3.34	3.89	4.32		
16	4.6	5.3	6.3	6	4.32	4.91	5.73		
25	–	6.6	7.8	4	5.45	6.18	7.26		
35	–	7.9	9.2	2	6.87	7.78	9.02		

NOTE: The diameters of the largest rigid and flexible conductors are based on Table 1 of IEC 60228 A/IEC 60344 and on ASTM B172-71 [4], IECA Publication S-19-81 [5], IECA Publication S-66-524 [6], as well as IECA Publication S-66-516 [7] for AWG conductors.

<sup>a)</sup> Dimensions for Class 5 flexible conductors only (IEC 60228 A)

<sup>b)</sup> Nominal diameter +5%

<sup>c)</sup> Largest diameter for conductors of classes I, K, M + 5%

In practical use, the conductor cross sections are approximately 5% below the values stated in the table!

The IEC 60999-1/EN 60999-1/VDE 0609-1 Specification (Section 7.1) requires that:

**Clamping units must be able to connect unprepared conductors.**

Under normal operating conditions, direct clamping (i.e., directly connecting a conductor to the terminal block's current bar) provides optimal contact quality, because all risk factors arising from anti-splaying methods are prevented.

Occasionally, conductor anti-splaying protection may be required, including various methods (see illustrations below).

Special requirements apply only in special application areas exposed to extremely corrosive atmospheres.

In this case, we recommend using either solid copper conductors or fine-stranded copper conductors with properly crimped, tin-coated copper ferrules or copper pin terminals.

As with solid copper conductors, the fine strands are crimped to a dense inner core. This prevents ingress of aggressive atmospheres (depending on the ppm concentration), which can diffuse into the conductor bundle along the individual strands and deposit between individual strands and the clamping point.

**One Conductor per Clamping Unit**

A number of DIN VDE, EN, IEC directives mandate or recommend that only one conductor must be connected per clamping unit.

In accordance with DIN VDE 0611, Part 4, 02.91, Section 3.1.9, multi-level distribution rail-mount terminal blocks must be dimensioned so that a single (solid, stranded or fine-stranded) conductor of the nominal cross section can be connected at each terminal point.

Other VDE, EN and IEC specifications also recommend the connection of only one conductor per clamping unit, unless the clamping unit is specifically tested and approved for the connection of several conductors, for example:

VDE 0609, Part 1, 12.00 / EN 60999-1:2000 / IEC 60999-1:1999, Section 7.1  
VDE 0660, Part 600, 06.12 / EN 61439-1:2011 / IEC 61439-1, Section 8.6.3  
VDE 0113, Part 1, 06.07 / EN 60204-1:2006 / IEC 60204-1:2016, Section 13.1.1.

- One conductor per clamping unit is therefore recommended to meet the safety requirements of these relevant specifications. This WAGO principle is the basis for a number of other technical and economic advantages:
- Each conductor may be terminated or removed without affecting previously connected conductors.
  - Where re-wiring is required, only the conductor to be changed is removed from the clamping point, all other conductors remain safely clamped.
  - Each conductor is clamped independently.
  - Any conductor size combination can be connected.

WAGO provides 2-conductor terminal blocks and connectors to increase the number of clamping units.

II. Per IEC 60999-2, Table 1:

Rated Cross-Section	Theoretical Largest Conductor Diameter					Connectable Conductor	
	Metric		AWG/kcmil			Rigid	Flexible
	Rigid Stranded	Fine-Stranded <sup>a)</sup>	Gauge	Rigid Stranded	Fine-Stranded		
mm <sup>2</sup>	mm	mm		mm	mm		
50	9.1	11	1/0	9.64	12.08	To be defined in the corresponding product standard	
70	11	13.1	2/0	11.17	13.54		
95	12.9	15.1	3/0	12.54	15.33		
–	–	–	4/0	14.08	17.22		
120	14.5	17	250	15.34	19.01		
150	16.2	19	300	16.8	20.48		
185	18	21	350	18.16	22.05		
–	–	–	400	19.42	24.05		
240	20.6	24	500	21.68	26.57		
300	23.1	27	600	23.82	30.03		

Dimensions for Class 5 flexible conductors only (IEC 60228 A)

NOTE: The diameters of the largest rigid and flexible conductors are based on Table 1 and Table 3 of IEC 3 A/IEC 60228 and on ASTM B172-71 [1], IECA Publication S-19-81 [2], IECA Publication S-66-524 [3], as well as IECA Publication S-66-516 [7] for AWG conductors.



Tip-bonded conductor



Tin-plated copper ferrule (gas-tight crimped)



Ultrasonically bonded conductor



Crimped pin terminal (gas-tight), preferably made of copper with a tin-plated surface

Anti-splaying methods require a terminal block one size larger than the nominal cross section of the conductor to be terminated. Ferruled conductor cross sections specified for individual products are based on WAGO's Variocrimp square crimping technology. Gas-tight, crimped twin ferrules may be used, provided the ferrule is inserted all the way into the clamping unit and that there is a sufficient clearance and creepage distance between adjacent potentials.



## Tests and Testing Procedures per IEC/EN Standards (continued)

### Mechanical Tests (continued)

- Pull-Out Test per IEC/EN 60947-7-1, IEC/EN 60998-2-2, IEC/EN 60999-1

The pull-out test simulates the mechanical stress on the clamping unit when, for example, the installer pushes the conductor aside to better access/operate the adjacent clamping unit, or verifies if the conductor is connected properly by briefly pulling on it.

During the test, a pulling force is applied without jerking, for one minute, to the connected conductor. The pulling force is selected according to the cross-sectional area. The larger the cross section of the conductor, the higher the pull-out force that is selected. For example, the pulling force is 40 N for a conductor having a cross section of 1.5 mm<sup>2</sup> (16 AWG) and 100 N for a conductor with a cross section of 16 mm<sup>2</sup> (6 AWG). The values specified by these standards are the same for both screw clamp and spring clamp terminal blocks. During the test, the conductor must neither slip out of the clamping unit, nor break near the clamping unit.

#### Conductor Pull-Out Forces

The clamping units of screwless terminal blocks must withstand the pull-out forces as follows:

IEC 60947-1/EN 60947-1/VDE 0660-100, Table 5:

Low-voltage switchgear and controlgear, general rules

IEC 60947-7-1/EN 60947-7-1/

VDE 0611-1, rail-mount terminal blocks for copper conductors

IEC 60998-2-1/EN 60998-2-1/

VDE 0613-2-1, Table 104:

IEC 60998-2-2/EN 60998-2-2

VDE 0613-2-2, Table 103:

Connecting devices for low-voltage circuits for household and similar purposes

Particular requirements for connecting devices as separate entities with screw-clamp or screwless terminal blocks.

IEC 60999-1/EN 60999-1/VDE 0609-1, Table 3:

IEC 60999-2/EN 60999-2/VDE 0609-101, Table 2:

Safety requirements for screw-clamp and screwless clamping units for electrical copper conductors

Rated Cross-Section		Pull-Out Forces per IEC/EN		
mm <sup>2</sup>	AWG/kcmil	60947-7-1	60998-2-2	60999-1/-2
		N	N	N
0.2	24	10	10	10
0.34	22	15	15	15
0.5	20	20	20	20
0.75	18	30	30	30
1	–	35	35	35
1.5	16	40	40	40
2.5	14	50	50	50
4	12	60	60	60
6	10	80	80	80
10	8	90	90	90
16	6	100	100	100
25	4	135	135	135
–	3	156		
35	2	190	190	190
–	1	236		
50	1/0	236		236
70	2/0	285		285
95	3/0	351		351
–	4/0	427		427
120	250	427		427
150	300	427		427
185	350	503		503
–	400	503		503
240	500	578		578
300	600	578		578



• Shock/Vibration Test per IEC/EN 60068-2-6; DNV GL, LR (Marine Applications); IEC/EN 61373 (Railway Applications)

The vibration test determines whether vibrations, such as those produced in the vicinity of machines or in vehicles, will permanently affect the electrical connection, or if contact breaks will occur during vibrations. Using a vibration table, the test specimen is subjected to vibration in each of the X, Y and Z axes (see pictures). The amplitude, acceleration and in particular the frequency of the vibration must vary during the test.

The "open length" of the conductor up to the point where the conductor is attached in the application must be kept as short as possible (length = 70 mm in this example).

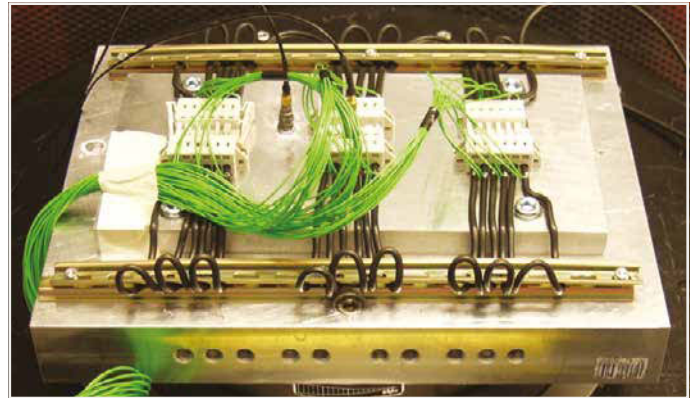
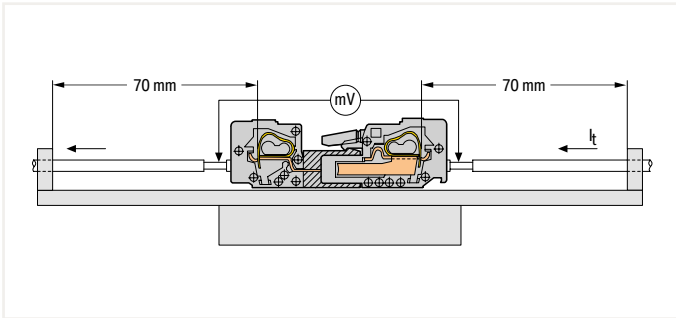

1st Axis

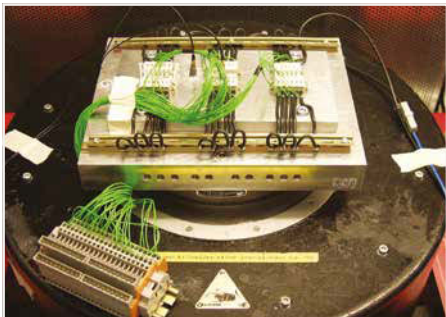

2nd Axis

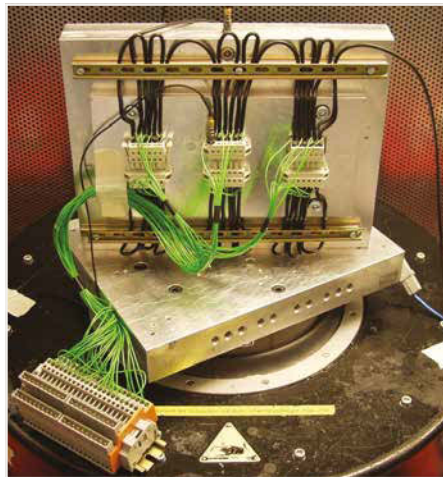

3rd Axis

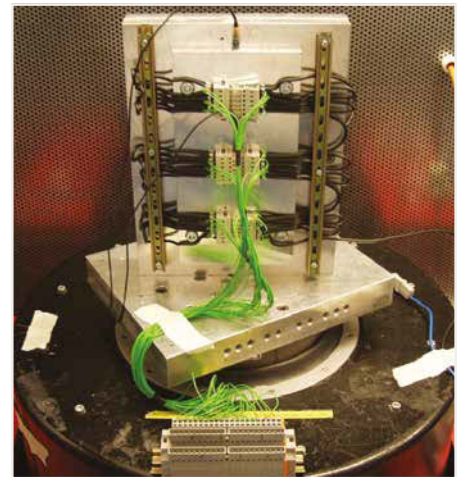

The exact test procedure may vary considerably, depending on how the product will be used.

Application Examples per IEC/EN 60068-2-6	Associated Test Levels	
Devices attached to heavy, rotating machines	1 ... 35 Hz,	50 m/s <sup>2</sup> (5 g) or 100 m/s <sup>2</sup> (10 g)
Devices designed for use in large-scale power plants and general industrial applications	10 ... 55 Hz,	20 m/s <sup>2</sup> (2 g) 50 m/s <sup>2</sup> (5 g)
Devices designed for use in large-scale power plants and general industrial applications if it has been determined that detectable vibration components greater than 55 Hz exist	10 ... 150 Hz,	20 m/s <sup>2</sup> (2 g) 50 m/s <sup>2</sup> (5 g)

## Tests and Testing Procedures per IEC/EN Standards (continued)

### Mechanical Tests (continued)

Beyond these standard procedures, each market segment performs additional testing. Examples include railway authorities testing rolling electrical equipment, or the testing performed multiple marine agencies (e.g., DNV GL Group, Lloyd's Register of Shipping). Though the requirements of such testing procedures are particularly demanding, test arrangements are identical for all of them. During vibrations, possible contact breaks are monitored on an oscilloscope. Voltage drop is measured before and after the test to detect permanent failures, i.e., checking if electrical resistance at the clamping unit has not increased beyond the permissible limit. The smaller this value is, the smaller the contact resistance of the clamping unit.

The test is passed if:

- the conductor has neither slipped out of the terminal block nor been damaged,
- the maximum permissible voltage drop has not been exceeded
- and neither contact breaks have occurred nor a defined break time has been exceeded.

The test specimen must not be damaged in any way that might affect future use.

Since their inception, both CAGE CLAMP® and Push-in CAGE CLAMP® connections have been routinely tested for their resistance to shock/vibration in connection with approval tests.

Notes:

These test results are based solely on tests conducted under "laboratory conditions." Connector usage in actual applications must be evaluated by the user.

• Shock Test per IEC/EN 60068-2-27; IEC/EN 61373 (Railway Applications)

The shock test is similar to the vibration test except that, instead of continuous vibrations, single shocks are applied to the specimen. Shock tests are usually performed with an acceleration of 20g, for example, over a period of 11 ms. Tests for special requirements often call for much higher values.

Like the vibration tests, shock tests are primarily used to test the voltage drop variation or contact breaks, etc.

**Example: Shock requirement**

per IEC/EN 60068-2-27 (half-sine shock)

30g acceleration, 6 ms duration

Shock direction: 3 axes (3 shocks each in positive and negative direction)

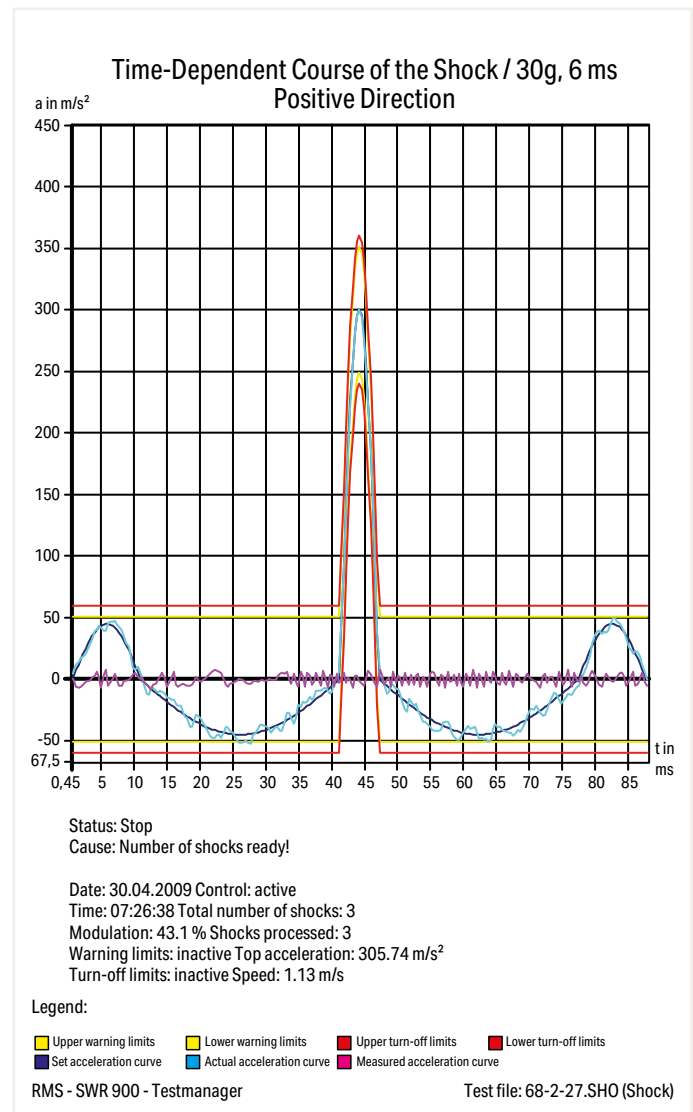
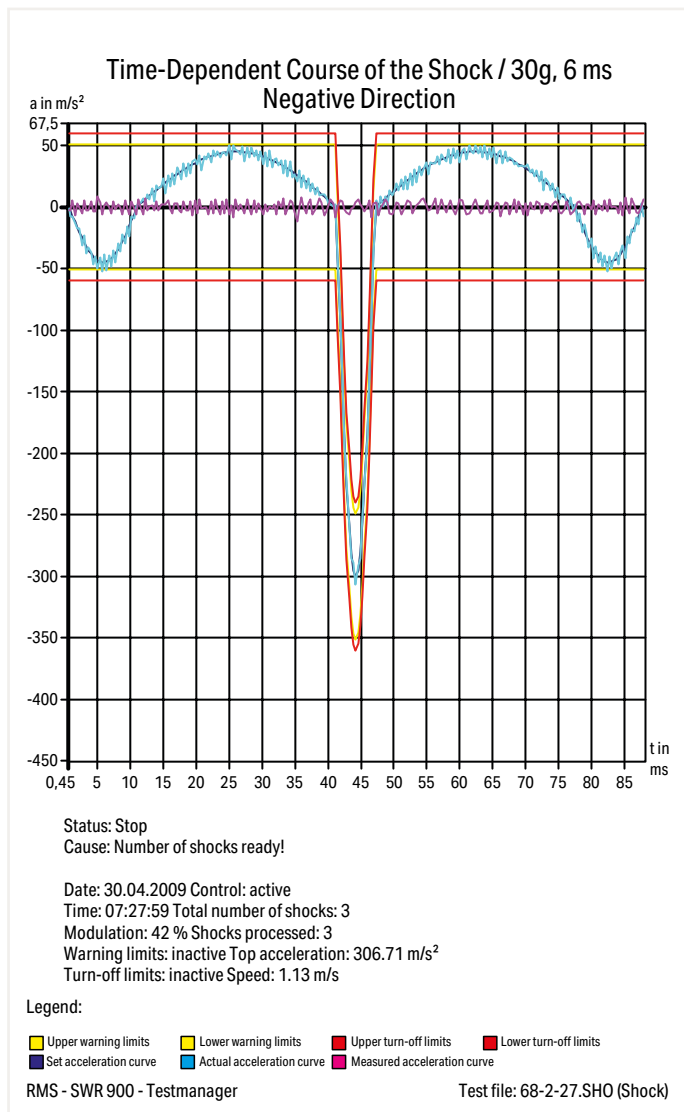

## Tests and Testing Procedures per IEC/EN Standards (continued)

### Electrical Tests

All WAGO products meet requirements for the following electrical tests:

- Temperature-Rise Test per IEC/EN 61984, IEC/EN 60947-7-4, IEC/EN 60947-7-1, IEC/EN 60998-1

The temperature-rise test examines the clamping unit – including the surrounding insulation – at rated current, over-current and short-circuit current levels.

Unless otherwise specified in the related equipment specification, e.g., by specifying the nominal currents of the equipment, terminal blocks and connectors are tested with current loads as specified in the respective construction specification.

For rail-mount terminal blocks complying with IEC 60947-7-1/EN 60947-7-1/VDE 0611-1, or terminal blocks complying with IEC 60998-1/EN 60998-1/VDE 0613-1, the temperature rise must not exceed 45 Kelvin.

Connectors and PCB terminal blocks must withstand the upper and lower values of the temperature range as specified in the detail or manufacturer’s specification.

The sum of the surrounding air temperature and the temperature rise of a connector or PCB terminal strip must not exceed the upper temperature limit.

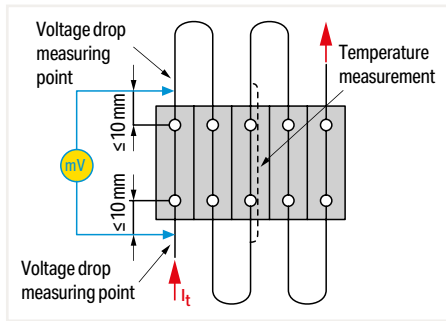

Test arrangement: "Temperature-Rise Test"

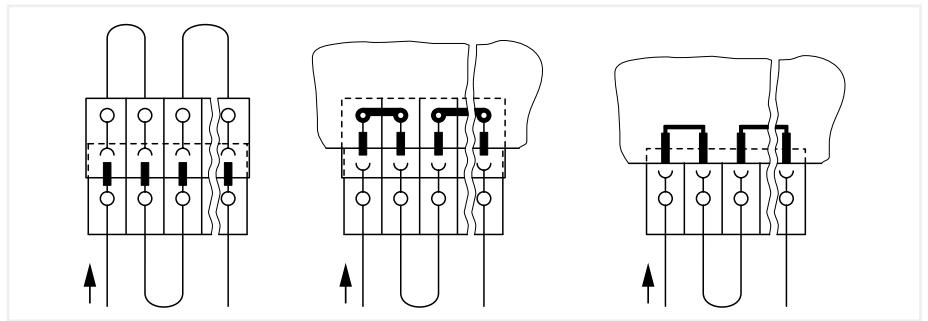

Test arrangement: "Temperature-Rise Test" per IEC/EN 61984

Rated Cross-Section	Test Current per IEC/EN		Conductor Size	Test Current per IEC/EN
	60947-7-1 Table 4	60998-1 Table 2		
mm <sup>2</sup>	A	A	AWG/kcmil	A
0.2	4	4	24	4
0.34	5	5	22	6
0.5	6	6	20	8
0.75	9	9	18	10
1	13.5	13.5	-	-
1.5	17.5	17.5	16	16
2.5	24	24	14	22
4	32	32	12	29
6	41	41	10	38
10	57	57	8	50
16	76	76	6	67
25	101	101	4	90
35	125	125	2	121
-	-	-	1	139
50	150	-	1/0	162
70	192	-	2/0	185
95	232	-	3/0	217
-	-	-	4/0	242
120	269	-	250 kcmil	271
150	309	-	300 kcmil	309
185	353	-	350 kcmil	353
240	415	-	500 kcmil	415
300	520	-	600 kcmil	520

- Current-Carrying Capacity Curve (Derating Curve) per EN 60512-5-2

Both the design requirements (e.g., dimensions) and the current-carrying capacity of a connector must be checked by the user when selecting connectors.

This information depends on the following factors: conductor size, surrounding air temperature, number of simultaneously loaded poles, internal resistance of the connector, PCB layout, width and thickness of the printed circuits and connector materials.

A current-carrying capacity curve (basic curve) is determined based on the EN 60512-5-2 standard, accounting for the upper temperature limit.

The relationship between current, surrounding air temperature and temperature rise up to the connector's upper temperature limit is illustrated via current-carrying capacity curve (derating curve, reduction factor: 0.8).

The connector must only be operated up to this temperature limit (sum of the self-generated heat and the surrounding air temperature) without being damaged or destroyed during operation.

**The nominal current figures given for the WAGO PCB Connectors are based on the maximum number of poles, the maximum conductor cross section and a maximum temperature rise of 45 K.**

Note: Current-carrying capacity curves merely document the self-generated heat of the connectors and terminal blocks under defined test conditions (conductor length, commoning of solder pins).

Usability of the components in actual applications must be investigated by the user.

Functioning of a current-carrying capacity curve (derating curve) per EN 60512-5-2 is shown by an application using a derating curve for the **MULTI CONNECTION SYSTEM**:

This application requires each pole of a 4-pole connector be subjected to a load of 20 A. Based on the derating curve determined for this pole number with a conductor cross section of 2.5 mm<sup>2</sup>, it has been determined the maximum surrounding air temperature is 39°C (102.2°F). The current must be reduced at higher surrounding air temperatures, e.g., to 11 A at an surrounding air temperature of 70°C (158°F).

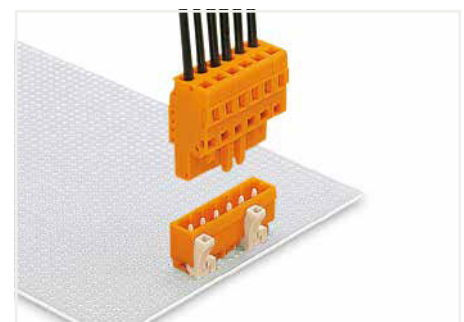
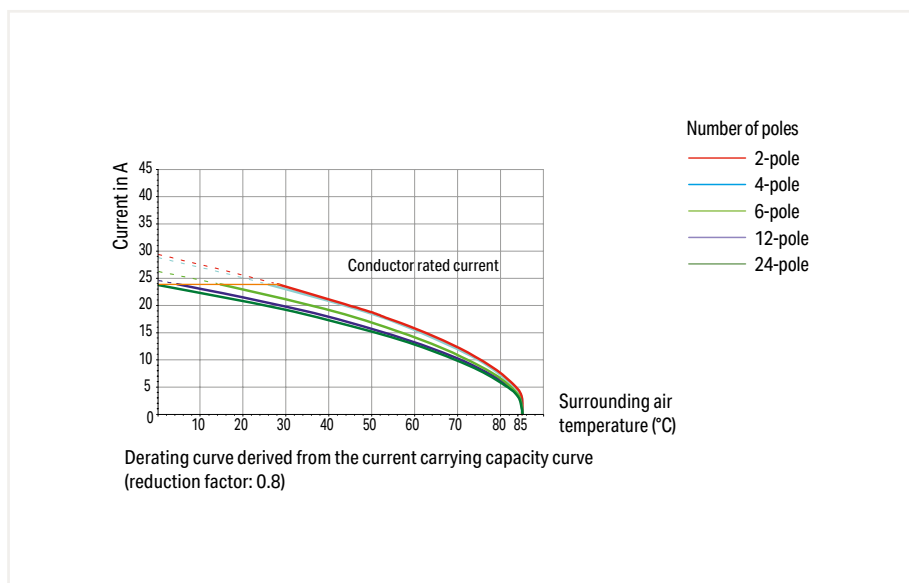

Male header with straight solder pins  
Female connector with CAGE CLAMP®

The non-reduced current-carrying capacity curves (basic curves, reduction factor: 1) can be used when selecting WAGO's PCB terminal blocks!

The nominal current values given are based on a 4-pole PCB terminal strip with a temperature rise of 45 K.



Example: 4-pole PCB terminal strip (2706 Series)

## Tests and Testing Procedures per IEC/EN Standards (continued)

### Electrical Tests (continued)

- Voltage Drop Test per IEC/EN 60947-7-1, IEC/EN 60999-1

The voltage drop test evaluates clamping point quality under stress such as vibration, temperature change, industrial climate and salt spray, in order to verify that the contact point is gas-tight.

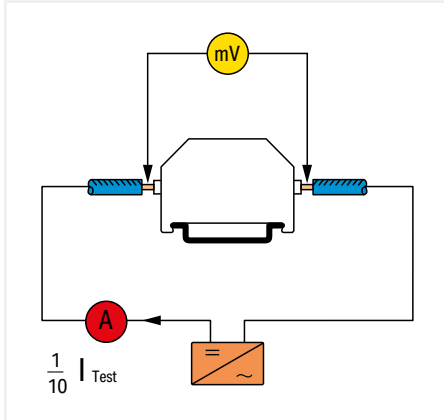

Test arrangement: "Voltage Drop Test"

Example: Current load cycling test result for Combi PCB terminal blocks with IDC and PUSH WIRE® connections

Voltage drop variation over longer periods under current load cycling conditions is shown for 251-3xx Combi PCB Terminal Blocks using solid copper conductors. The diagram shows that the voltage drop is constant, far beyond the 192 cycles required in IEC/EN 60998-2-2.

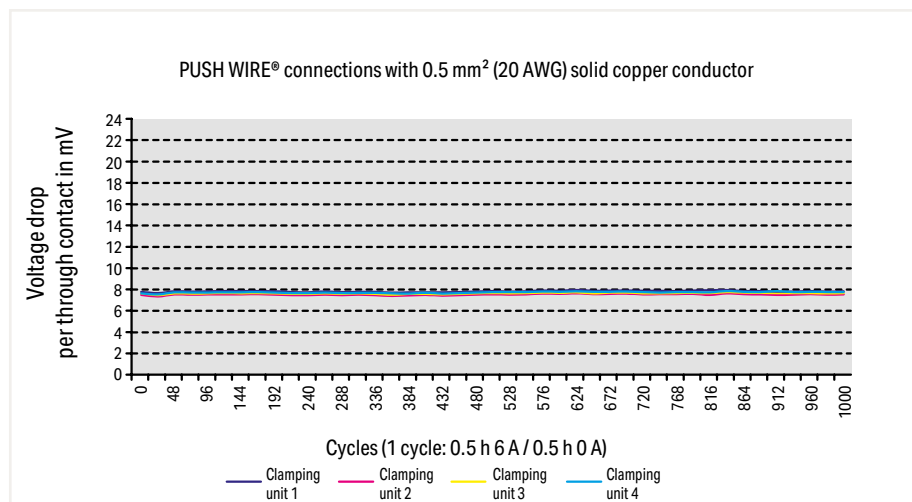
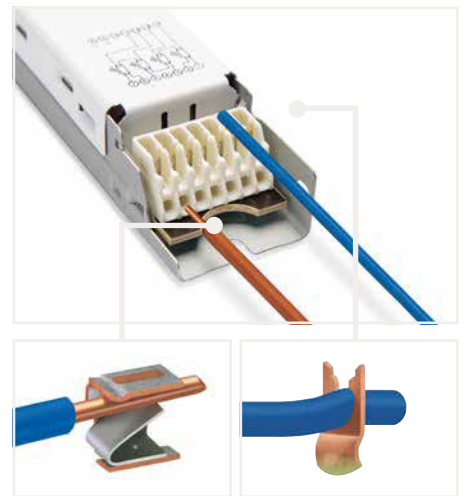
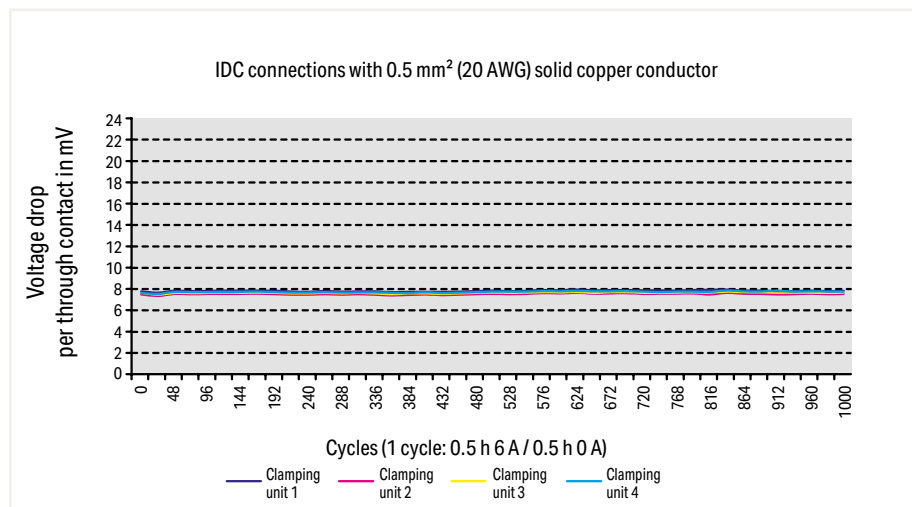

The voltage drop was determined at the rated current.

#### • Minimum Current / Specialty Connector Applications

The contact surfaces of WAGO's connectors are tin-plated. This surface exhibits excellent conductivity, along with outstanding protection against corrosion. Pollution layer deposits may penetrate this pure tin coating when the contacts are connected, lowering contact resistance.

The following information regarding proper selection of suitable WAGO components should be considered for applications in which connectors are used with minimal current and voltage levels and under harsh conditions, involving, for example, temperature, aggressive gases, vibration and shock.

Signal corruption may occur in applications with minimal current and voltage levels under the special conditions cited above. In such cases, we recommend using gold-plated contacts. Here, the user must always examine the suitability of the connectors for the application at hand.

The diagram below is based on practical experience.

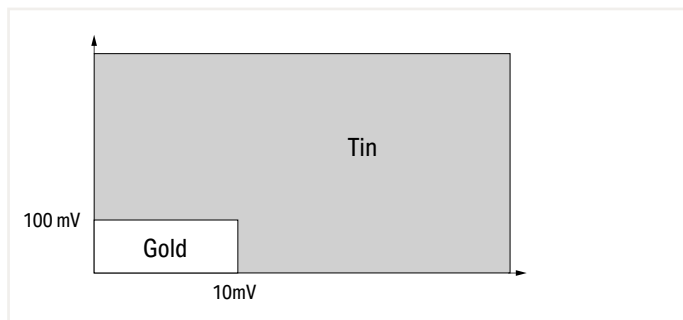

WAGO also offers connectors with gold-plated contacts upon request.



## Tests and Testing Procedures per IEC/EN Standards (continued)

### Electrical Tests (continued)

• Insulation Parameters per IEC/EN 60664-1

#### Clearances and Creepage Distances

The following generally applies:

The equipment specification contains data for the measurement of clearances and creepage distances, or refers to the data contained in the new revised edition of the basic standard DIN EN 60664-1/VDE 0110-1. This standard contains new clearances and creepage distances in compliance with insulation coordination requirements. That is, the insulation parameters of equipment are assigned to:

- the anticipated surge voltages
- the parameters of the protection device against impulse voltage
- the anticipated environmental conditions and the protection measures against pollution.

This standard is based on IEC 60604-1.

#### Overvoltage Categories for Electrical Equipment:

A specific overvoltage category must be defined on the basis of the following, general description:

- Equipment in **overvoltage category I** is intended to be connected to the fixed electrical installations of buildings. Protective means are taken outside the equipment – either in the fixed installation or between the fixed installation and the equipment – to limit transient overvoltages to the specific level.
- Equipment in **overvoltage category II** is to be connected to the fixed electrical installations of buildings.

**Note:** Examples of such equipment are household appliances, portable tools and similar loads.

- Equipment in **overvoltage category III** is part of the fixed electrical installations and other equipment where a higher degree of availability is expected.

**Note:** Examples of such equipment are distribution boards, circuit breakers, wiring systems (IEV 826-16-08, including cables, bus bars, junction boxes, switches, socket outlets) in the fixed installation and equipment for industrial use and other equipment, e.g., stationary motors with permanent connection to the fixed installation.

- Equipment in **overvoltage category IV** is for use in or near the feed-in of electrical building installations upstream of the main distribution board in the direction of the network.

**Note:** Examples include electricity meters, primary overcurrent protection devices and ripple control units.

#### Clearances, Rated Surge Voltages, Overvoltage Categories, Pollution Degrees

Surge voltages (Table 1) are a decisive factor in determining clearances.

The basis forms the **overvoltage category**, i.e., the allocation of the equipment to the expected overvoltage, and the **conductor-ground voltage** derived from the nominal mains voltage in installations with a grounded Y (star) point.

In ungrounded installations, or installations where the conductor is not grounded, the voltage between conductors is applicable in the same way as conductor voltage to ground.

The rated surge voltage must be selected from Table F.1 corresponding to the overvoltage category specified and to the rated voltage of the equipment.

Table F.1 – Rated Surge Voltage for Equipment Energized Directly from the Low-Voltage Mains (DIN EN 60664-1/VDE 0110-1)

Voltage Curve: 1.2/50  $\mu$ s per IEC 60060-1/VDE 0432-1

Nominal voltage of the power supply system <sup>1)</sup> (mains) per IEC 60038 <sup>2)</sup>		Conductor-to-neutral voltage, derived from the nominal AC or DC voltage up to and including: V	Rated surge voltage <sup>2)</sup>  Overvoltage category <sup>4)</sup>			
Three-phase V	Single-phase V		I V	II V	III V	IV V
		50	330	500	800	1500
		100	500	800	1500	2500
	120 ... 240	150 <sup>5)</sup>	800	1500	2500	4000
230 / 400 277 / 480		300	1500	2500	4000	6000
400 690		600	2500	4000	6000	8000
1000		1000	4000	6000	8000	12000

<sup>1)</sup> See Annex B for application to existing different low-voltage mains and their nominal voltages.

<sup>2)</sup> Equipment with these rated impulse voltage levels can be used in installations complying with IEC 60364-4-443.

<sup>3)</sup> The / mark indicates a 3-phase, 4-conductor system. The lower value is the conductor-to-neutral voltage, while the higher value is the conductor-to-conductor voltage. Where only one value is indicated, it refers to 3-phase, 3-conductor systems and specifies the conductor-to-conductor voltage.

<sup>4)</sup> See 4.3.3.2.2 for an explanation of the overvoltage categories.

<sup>5)</sup> The nominal voltages for single-phase systems in Japan are 100 V or 100 ... 200 V. The value for the rated impulse voltage is, however, derived from the voltage gaps conductor-to-neutral for a voltage level of 150 V (see Annex B).

The nominal supply voltage and the corresponding rated impulse voltage values apply for grounded and ungrounded circuits.

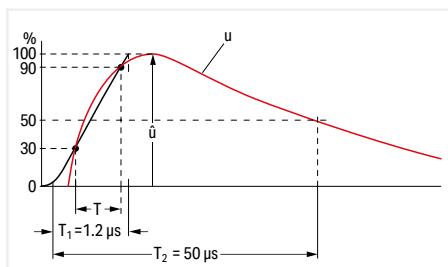

Voltage pulse: 1.2/50  $\mu$ s per EN 60060-1/VDE 0432-1

## Pollution Degrees

Pollution factors are all solid, liquid or gaseous foreign matter which may reduce the dielectric strength or the specific surface resistance. Factors are divided into four classes based on expected environmental conditions:

		Examples of pollution degrees for assigned areas:
Pollution degree 1:	No pollution, or only dry, non-conductive pollution occurs. Pollution has no influence.	Open, unprotected insulated equipment in air-conditioned or clean, dry rooms
Pollution degree 2:	Only non-conductive pollution occurs. Occasional, temporary conductivity caused by condensation can also be expected.	Open, unprotected insulated equipment in occupied areas, shops, laboratories, mechanical workshops and medical rooms.
Pollution degree 3:	Conductive pollution occurs, or dry, non-conductive pollution occurs which will become conductive due to condensation.	Open, unprotected insulated equipment in industrial, business and farming areas (e.g., unheated rooms, workshops and boiler rooms)
Pollution degree 4:	The pollution generates persistent conductivity caused by conductive dust, rain or wet conditions.	Open, unprotected insulated equipment for outdoor use

## Dimensioning Clearances

(DIN EN 60664-1/VDE 0110-1, Table F.2) Select the minimum clearances in accordance with the rated surge voltages and pollution degrees. To maximize the operating life of the equipment, do not go below these minimum clearances.

Table F.2 contains a list of information for Case A, the inhomogeneous field and for Case B, the homogeneous field. This involves an electric field with essentially constant (Case B) or non-constant (Case A) voltage gradients between the electrodes. **Equipment with a clearance that is dimensioned per Case A, in other words rated for the most unfavorable case, requires no verification by the impulse voltage test.** Equipment with a clearance that is dimensioned per Case B, or between A and B, requires verification by the impulse voltage test.

The clearances shown in Table F.2 are applicable for an installation height of up to 2000 m above sea level.

Values for clearances above 2000 m must be multiplied by a high correction factor in accordance with Table A.2.

**Table F.2 – Clearances to Withstand Transient Overvoltages**  
DIN EN 60664-1/VDE 0110-1

Required Impulse Withstand Voltage <sup>1)5)</sup>	Minimum Clearances in Air up to 2000 m Above Sea Level					
	Case A Inhomogeneous Field (see 3.15)			Case B Homogeneous Field (see 3.14)		
	Pollution Degree <sup>6)</sup>			Pollution Degree <sup>6)</sup>		
	1 mm	2 mm	3 mm	1 mm	2 mm	3 mm
0.33 <sup>2)</sup>	0.01	0.2 <sup>3)4)</sup>	0.8 <sup>4)</sup>	0.01	0.2 <sup>3)4)</sup>	0.8 <sup>4)</sup>
0.4	0.02			0.02		
0.5 <sup>2)</sup>	0.04			0.04		
0.6	0.06			0.06		
0.8 <sup>2)</sup>	0.10			0.10		
1	0.15			0.15		
1.2	0.25	0.25	0.2	0.3	0.3	0.3
1.5 <sup>2)</sup>	0.5	0.5	0.3			
2	1	1	0.45			
2.5 <sup>2)</sup>	1.5	1.5	1.5	0.6	0.6	0.6
3	2	2	2	0.8	0.8	0.8
4 <sup>2)</sup>	3	3	3	1.2	1.2	1.2
5	4	4	4	1.5	1.5	1.5
6 <sup>2)</sup>	5.5	5.5	5.5	2	2	2
8 <sup>2)</sup>	8	8	8	3	3	3
10	11	11	11	3.5	3.5	3.5
12 <sup>2)</sup>	14	14	14	4.5	4.5	4.5
15	18	18	18	5.5	5.5	5.5
20	25	25	25	8	8	8
25	33	33	33	10	10	10
30	40	40	40	12.5	12.5	12.5
40	60	60	60	17	17	17
50	75	75	75	22	22	22
60	90	90	90	27	27	27
80	130	130	130	35	35	35
100	170	170	170	45	45	45

<sup>1)</sup> This voltage is for:

- Functional insulation: the maximum impulse voltage expected to occur across the clearance (see 5.1.5)
- Basic insulation directly exposed to or significantly influenced by transient overvoltages from the low-voltage mains (see 4.3.3.3, 4.3.3.4.1 and 5.1.6): the rated impulse voltage for the equipment;
- Other basic insulation (see 4.3.3.4.2): the highest impulse voltage that can occur in the circuit  
For reinforced insulation, see 5.1.6.

<sup>2)</sup> Preferred values specified in 4.2.3

<sup>3)</sup> For printed wiring material, the values for pollution degree 1 apply, except that the value must not be less than 0.04 mm, as specified in Table F.4.

<sup>4)</sup> The minimum clearances given for pollution degree 2 and 3 are based on the reduced withstand characteristics of the associated creepage distance under humidity conditions (see IEC 60664-5).

<sup>5)</sup> For parts or circuit within equipment subject to surge voltages based on 4.3.3.4.2, interpolation of values is allowed. However, standardization is achieved by using the preferred series of impulse voltage values based on 4.2.3.

<sup>6)</sup> The dimensions for pollution degree 4 are as specified for pollution degree 3, except that the minimum clearance is 1.6 mm.

## Tests and Testing Procedures per IEC/EN Standards (continued)

### Electrical Tests (continued)



#### • Insulation Parameters per IEC/EN 60664-1 (continued)

#### Creepage Distances, Rated Voltages, Material Groups

Criteria for dimensioning creepage distances are the rated voltages, pollution degrees and material groups.

The pollution degrees specified for the clearances, and its quoted allocation to locations, is also applicable for creepage distances. Tables F.3 a and F.3 b of DIN EN 60664-1/ VDE 0110-1 contain the rated voltages that have to be considered for dimensioning the minimum creepage distances.

Table F.3a – Single-Phase, 3- or 2-Conductor, AC or DC Systems

Nominal Voltage of the Power Supply System (Mains)*	Voltages for Table F.4	
	For insulation conductor-to-conductor <sup>1)</sup>	For insulation conductor-to-ground <sup>1)</sup>
	All systems 	Three-conductor systems, center-point grounded 
V	V	V
12.5	12.5	
24 25	25	
30	32	
42 48 50**	50	
60	63	
30 to 60	63	32
100**	100	
110 120	125	
150**	160	
200	200	
110 to 200	200	100
220	250	
110 to 220 120 to 240	250	
300**	320	
220 to 440	500	250
600**	630	
480 to 960	1000	500
1000**	1000	

<sup>1)</sup> Conductor-to-ground insulation level for non-grounded or impedance-grounded systems equals that for conductor-to-conductor, as the operating voltage to ground of any conductor can, in practice, approach full conductor-to-conductor voltage. This is because the actual voltage to ground is determined by the insulation resistance and capacitive reactance of each conductor to ground; thus, low (but acceptable) insulation resistance of one conductor can in effect ground it and raise the other two to full conductor-to-conductor voltage to ground.

\*For the relationship to rated voltage, see 4.3.2.

\*\*These values correspond to the values given in Table F.1.

Altitude m	Standard Air Pressure (in kPa)	Multiplier for Clearances
2000	80	1
3000	70	1.14
4000	62	1.29
5000	54	1.48
6000	47	1.7
7000	41	1.95
8000	35.5	2.25
9000	30.5	2.62
10000	26.5	3.02
15000	12	6.67
20000	5.5	14.5

Table F.3b – Single-Phase, 4- or 3-Conductor AC Systems

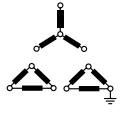
Nominal Voltage of the Power Supply System (Mains)*	Voltages for Table F.4		
	For insulation conductor-to-conductor <sup>1)</sup>	For insulation conductor-to-ground <sup>1)</sup>	
	All systems	Three-phase, 4-conductor systems with grounded neutral conductor <sup>2)</sup>	Three-phase, 3-conductor systems, non-grounded <sup>1)</sup> or grounded conductor
V	V		
V	V	V	V
60	63	32	63
110 120 127	125	80	125
150**	160		160
200	200		200
208	200	125	200
220 230 240	250	160	250
300**	320		320
380 400 415	400	250	400
440	500	250	500
480 500	500	320	500
575	630	400	630
600**	630		630
660 690	630	400	630
720 830	800	500	800
960	1000	630	1000
1000**	1000		1000

<sup>1)</sup> Conductor-to-ground insulation level for non-grounded or impedance-grounded systems equals that for conductor-to-conductor, as the operating voltage to ground of any conductor can, in practice, approach full conductor-to-conductor voltage. This is because the actual voltage to ground is determined by the insulation resistance and capacitive reactance of each conductor to ground; thus, low (but acceptable) insulation resistance of one conductor can in effect ground it and raise the other two to full conductor-to-conductor voltage to ground.

<sup>2)</sup> For equipment used on both three-phase, 4-conductor and three-phase, 3-conductor systems, grounded and non-grounded, use only the values for 3-conductor systems.

\*For the relationship to rated voltage, see 4.3.2.

\*\*These values correspond to the values given in Table F.1.

### Material Groups

Insulation materials are classified into four groups according to their Comparative Tracking Index (CTI) as follows:

Material Group I:  $600 \leq \text{CTI}$

Material Group II:  $400 \leq \text{CTI} < 600$

Material Group IIIa:  $175 \leq \text{CTI} < 400$

Material Group IIIb:  $100 \leq \text{CTI} < 175$

The CTI values above refer to values obtained in accordance with DIN EN 60664-1/ VDE 0110-1 on samples specially made for this purpose and tested with Solution A.

## Tests and Testing Procedures per IEC/EN Standards (continued)

### Electrical Tests (continued)

• Insulation Parameters per IEC/EN 60664-1 (continued)

**Table F.4 – Creepage Distances to Avoid Failure due to Tracking**  
DIN EN 60664-1/VDE 0110-1

Voltage <sup>1)</sup> (RMS)	Minimum Creepage Distances								
	Printed Circuits		Pollution Degree						
	Pollution Degree		1	2	2	2	3	3	3
	1 All Material Groups	2 All Material Groups except IIIb	1 All Material Groups	Material Group I	Material Group II	Material Group III	Material Group I	Material Group II	Material Group III <sup>2)</sup>
V	mm	mm	mm	mm	mm	mm	mm	mm	mm
10	0.025	0.04	0.08	0.4	0.4	0.4	1	1	1
12.5	0.025	0.04	0.09	0.42	0.42	0.42	1.05	1.05	1.05
16	0.025	0.04	0.1	0.45	0.45	0.45	1.1	1.1	1.1
20	0.025	0.04	0.11	0.48	0.48	0.48	1.2	1.2	1.2
25	0.025	0.04	0.125	0.50	0.5	0.5	1.25	1.25	1.25
32	0.025	0.04	0.14	0.53	0.53	0.53	1.3	1.3	1.3
40	0.025	0.04	0.16	0.56	0.8	1.1	1.4	1.6	1.8
50	0.025	0.04	0.18	0.6	0.85	1.2	1.5	1.7	1.9
63	0.04	0.063	0.2	0.63	0.9	1.25	1.6	1.8	2
80	0.063	0.1	0.22	0.67	0.95	1.3	1.7	1.9	2.1
100	0.1	0.16	0.25	0.71	1	1.4	1.8	2	2.2
125	0.16	0.25	0.28	0.75	1.05	1.5	1.9	2.1	2.4
160	0.25	0.4	0.32	0.8	1.1	1.6	2	2.2	2.5
200	0.4	0.63	0.42	1	1.4	2	2.5	2.8	3.2
250	0.56	1	0.56	1.25	1.8	2.5	3.2	3.6	4
320	0.75	1.6	0.75	1.6	2.2	3.2	4	4.5	5
400	1	2	1	2	2.8	4	5	5.6	6.3
500	1.3	2.5	1.3	2.5	3.6	5	6.3	7.1	8 (7.9) <sup>4)</sup>
630	1.8	3.2	1.8	3.2	4.5	6.3	8 (7.9) <sup>4)</sup>	9 (8.4) <sup>4)</sup>	10 (9) <sup>4)</sup>
800	2.4	4	2.4	4	5.6	8	10 (9) <sup>4)</sup>	11 (9.6) <sup>4)</sup>	12.5 (10.2) <sup>4)</sup>
1000	3.2	5	3.2	5	7.1	10	12.5 (10.2) <sup>4)</sup>	14 (11.2) <sup>4)</sup>	16 (12.8) <sup>4)</sup>
1250			4.2	6.3	9	12.5	16 (12.8) <sup>4)</sup>	18 (14.4) <sup>4)</sup>	20 (16) <sup>4)</sup>
1600			5.6	8	11	16	20 (16) <sup>4)</sup>	22 (17.6) <sup>4)</sup>	25 (20) <sup>4)</sup>
2000			7.5	10	14	20	25 (20) <sup>4)</sup>	28 (22.4) <sup>4)</sup>	32 (25.6) <sup>4)</sup>
2500			10	12.5	18	25	32 (25.6) <sup>4)</sup>	36 (28.8) <sup>4)</sup>	40 (32) <sup>4)</sup>
3200			12.5	16	22	32	40 (32) <sup>4)</sup>	45 (36) <sup>4)</sup>	50 (40) <sup>4)</sup>
4000			16	20	28	40	50 (40) <sup>4)</sup>	56 (44.8) <sup>4)</sup>	63 (50.4) <sup>4)</sup>
5000			20	25	36	50	63 (50.4) <sup>4)</sup>	71 (56.8) <sup>4)</sup>	80 (64) <sup>4)</sup>
6300			25	32	45	63	80 (64) <sup>4)</sup>	90 (72) <sup>4)</sup>	100 (80) <sup>4)</sup>
8000			32	40	56	80	100 (80) <sup>4)</sup>	110 (88) <sup>4)</sup>	125 (100) <sup>4)</sup>
10000			40	50	71	100	125 (100) <sup>4)</sup>	140 (112) <sup>4)</sup>	160 (128) <sup>4)</sup>
12500			50 <sup>3)</sup>	63 <sup>3)</sup>	90 <sup>3)</sup>	125 <sup>3)</sup>			
16000			63 <sup>3)</sup>	80 <sup>3)</sup>	110 <sup>3)</sup>	160 <sup>3)</sup>			
20000			80 <sup>3)</sup>	100 <sup>3)</sup>	140 <sup>3)</sup>	200 <sup>3)</sup>			
25000			100 <sup>3)</sup>	125 <sup>3)</sup>	180 <sup>3)</sup>	250 <sup>3)</sup>			
32000			125 <sup>3)</sup>	160 <sup>3)</sup>	220 <sup>3)</sup>	320 <sup>3)</sup>			
40000			160 <sup>3)</sup>	200 <sup>3)</sup>	280 <sup>3)</sup>	400 <sup>3)</sup>			
50000			200 <sup>3)</sup>	250 <sup>3)</sup>	360 <sup>3)</sup>	500 <sup>3)</sup>			
63000			250 <sup>3)</sup>	320 <sup>3)</sup>	450 <sup>3)</sup>	600 <sup>3)</sup>			

<sup>1)</sup> This voltage is for:

- Functional insulation; the working voltage
- Basic and supplementary insulation of the circuit energized directly from the mains (see 4.3.2.2.1): for the voltage rationalized through Table F.3a or F.3b, based on the rated voltage of the equipment, or the rated insulation voltage
- Basic and supplementary insulation of systems, equipment and internal circuits not energized directly from the mains (see 4.3.2.2.2): the highest rms voltage which can occur in the system, equipment or internal circuit when supplied at rated voltage and under the most taxing combination of operation conditions within equipment rating

<sup>2)</sup> Material group IIIb is not recommended for applications in pollution degree 3 above 630 V.

<sup>3)</sup> Provisional data based on extrapolation. Technical committees who have other information based on experience may use their dimensions.

<sup>4)</sup> The values in brackets must only be applied for reducing creepage distances if a rib is used (see 5.2.5).

The high degree of accuracy of the creepage distances given in the table does not imply that the measuring accuracy must be of the same quality.

Depending on the intended use, WAGO's terminal blocks, splicing and pluggable connectors are suitable for pollution degrees 2 or 3 and for overvoltage categories II or III. The rated voltages of WAGO's PCB terminal blocks and connectors are based on pollution degree 2 and overvoltage category III in per IEC/EN 60664-1 (insulation parameters).

Example:

**WAGO 236 Series PCB Terminal Strips**  
(5/5.08 mm pin spacing)

320 V/4kV/2

Rated voltage	320 VDC
Rated surge voltage	4 kV
Pollution degree	2
Overvoltage category	III

The specific values for pollution degree 3 and overvoltage category II are also given in the technical data.

The clearances and creepage distances required for defined voltage values in Table 3 of IEC/EN 60998-1 deviate somewhat from the requirements specified in the insulation parameters.

**Table 3 – Clearances and Creepage Distances**  
(IEC/EN 60998-1)

Rated Insulation Voltage V	Clearances/Creepage Distances mm
≤ 130	1.5
> 130 and ≤ 250	3
> 250 and ≤ 450	4
> 450 and ≤ 750	6
> 750	8

## Tests and Testing Procedures per IEC/EN Standards (continued)

### Electrical Tests (continued)

#### • Power-Frequency Withstand Voltage Test per IEC/EN 60947-7-4, IEC/EN 60998-1

This testing procedure verifies creepage distances. Creepage distances, i.e., the distances of creeping currents, are caused by conductive impurities on the surface of the insulation housing. Apart from the amount of impurities to which a terminal block is subjected, for example, the plastic material and housing design are also involved in generating creeping currents. The insulation material of the housing may be carbonized by a creeping current, which further increases conductivity.

The specimen is tested using a power-frequency withstand voltage for a short time. For example, a PCB terminal block designed to operate at 320 V nominal voltage is usually tested using 2200 V alternating voltage for one minute. The test is passed if no flashovers or breakdowns have occurred.

#### • Rated Impulse Withstand Voltage Test per IEC/EN 60947-7-4, IEC/EN 60664-1

This test verifies the clearances of a product. In simplified terms, clearance is the distance between two poles of a terminal block. If this distance is too small, voltage peaks may cause flashovers or breakdowns. The arrangement of the rated impulse withstand voltage test is identical to that of the power frequency withstand voltage test; the test voltages, however, are comparatively higher and the testing times shorter, e.g., 4.8 kV over 50 µs (see figure).

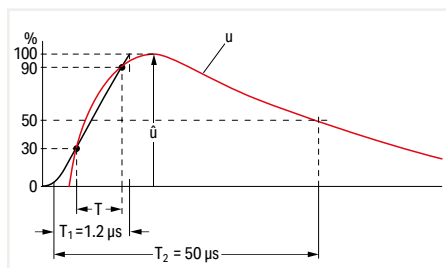

Voltage pulse: measurement curve (red) and auxiliary curve (black) for calculating the rate of rise of the pulse and the resulting (virtual) peak of the curve.

- T: Time interval for calculating the rate of rise
- T1: Front time (duration between start of impulse and reaching the peak)
- T2: Total pulse duration

The test values are the values at sea level as specified in the relevant test specification. The values indicated in the catalog correspond to an altitude of 2000 m. The test is passed if no flashovers or breakdowns have occurred.

Voltage pulse: 1.2/50 µs per EN 60060-1/VDE 0432-1

#### • IP Ratings for Electrical Equipment per IEC/EN 60529

Alphanumeric Nomenclature for Type of Protection				IP vs. NEMA	
Code letters IP	Protection against accidental contact and against the penetration of foreign objects or water	IP (Ingress Protection) = International degree of protection		IP Code	NEMA
First code number 0 to 6	Indicates the degree of protection against accidental contact and the penetration of foreign objects.	If indicating the degree of protection requires only one digit, the other (second) digit must be substituted for with an X.		10	1
Second code number 0 to 8	Indicates the degree of protection against water penetration.			11	2
First code number:		Second code number:		54	3
IP0X	No protection against accidental contact or the penetration of foreign objects	IPX0	No protection against water	14	3R
IP1X	Protection against foreign objects > 50 mm	IPX1	Protection against vertically falling water	54	3S
IP2X	Protection against foreign objects > 12 mm (e.g., finger)	IPX2	Protection against diagonally dripping water (15° angle)	55	4&4X
IP3X	Protection against foreign objects > 2.5 mm	IPX3	Protection against water spray	52	5
IP4X	Protection against foreign objects > 1 mm	IPX4	Protection against water spray	67	6&6P
IP5X	Protection against damaging dust deposits	IPX5	Protection against water jet, e.g., from a nozzle	52	12&12K
IP6X	Protection against dust penetration	IPX6	Protection against flooding	54	13
		IPX7	Protection against temporary immersion		
		IPX8	Protection against continuous immersion		
		IPX9	Protection against high-pressure and high-temperature water jets		



## Tests and Testing Procedures per IEC/EN Standards (continued)

### Material Tests

All WAGO products meet requirements for the following material tests:

- Needle Flame Test per IEC/EN 60947-7-1, IEC/EN 60695-11-5

This test simulates flames that may arise under certain conditions (e.g. fault current over a creepage distance, overloading of parts or components). Nearby parts can also be affected by such flames.

Not only the ignition of the test specimen resulting from an intrinsic defect is tested, but also its behavior when other parts ignite.

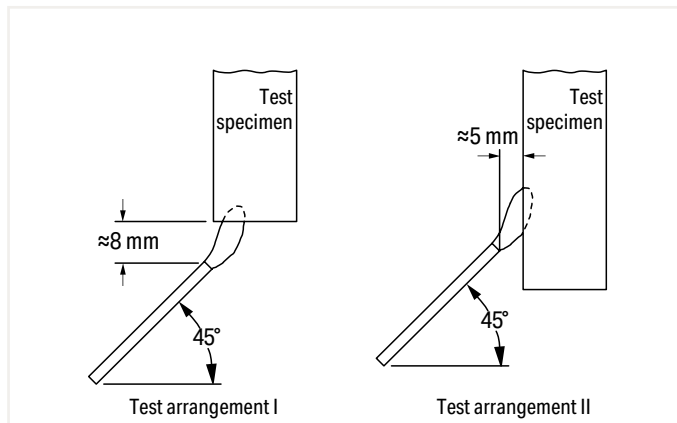

Flames must not be fuelled by the insulation materials used, thus creating a larger fire. The test specimen is exposed to a standard gas flame during a defined time period (e.g., ten seconds).

After the test flame has been removed, the specimen must self-extinguish within 30 seconds. Furthermore, a layer of tissue paper located beneath the specimen must not be ignited by glowing particles falling from the specimen.

- Glow-Wire Test per IEC/EN 60947-7-4, IEC/EN 60998-1, IEC/EN 60695-2-11

In the event of failure, a high current may cause a conductor to glow.



However, the glowing conductor shall not cause ignition of the product involved (e.g., a rail-mount terminal block). For the glow-wire test, the tip of the glow-wire is pressed against a surface of the test specimen (see picture).

The position of the test specimen, surface to be tested, test duration and glow-wire temperature (e.g., 960°C/1760°F over 30 seconds, or 850°C/1562°F over 5 seconds) are specified in the standards.

The specimen must be positioned such that the tip of the glow-wire acts on the surface section of the specimen (vertical surface of the specimen) that is most likely to be exposed to thermal loading during normal use.

As the highest temperature in the event of a fault is anticipated at the contact insert/wire connection, the tip of the glow-wire must act upon the section of the insulation housing that is the closest to this contact point. The test is passed if there are no visible flames or permanent glowing, or if flames or glowing extinguish within 30 seconds after removal of the glow-wire. Furthermore, a layer of tissue paper located beneath the specimen must not be ignited by glowing particles falling from the specimen.

## Tests and Testing Procedures per IEC/EN Standards (continued)

### Environmental Tests

The following tests show how a product reacts when exposed to an aggressive environment. Climatic chambers simulate standard atmospheres that could impact the long-term consistency of clamping units.

All WAGO products meet the requirements of the following environmental tests:

- Temperature Cycling Test per IEC/EN 60947-7-1, IEC/EN 60998-2-2

This test shows the change of voltage drop over longer periods under temperature cycling conditions. The test procedure usually consists of 192 temperature cycles, for example, each cycle having a duration of 60 minutes (see diagram).

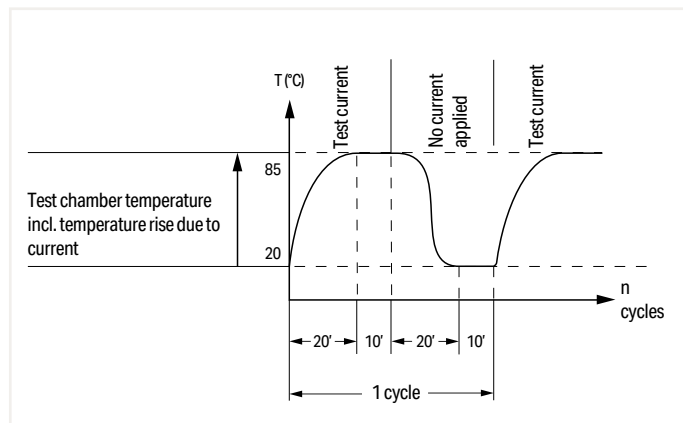

The rated current is applied to the test specimen during temperature rise and when the temperature has reached its maximum value; during the second half of the cycle, the current is zero. Voltage drop is measured every 24 cycles and must not exceed a maximum value or vary greatly. The voltage drop measured at the end of the 192nd cycle must not exceed 1.5 times the value measured after the 24th cycle. After the test, an inspection must show no changes that would impair further use of the product.

- Industrial Atmospheres per EN ISO 6988, IEC/EN 60068-2-42, IEC/EN 60068-2-60

Sulphur and its combustion products are particularly aggressive pollutants commonly found in industrial environments. A test procedure simulating such corrosive conditions consists of exposing a test specimen to water condensation in variable atmospheres containing sulphur dioxide.



A saturated atmosphere is first created in a climatic chamber by heating an aqueous sulphur dioxide solution. After less than half an hour, the test specimen is fully saturated by the condensing vapors and exposed to this atmosphere for eight hours.

After exposure to a humid atmosphere, the test specimen is subjected to dry and cooler conditions at room temperature for 16 hours. Depending on the test severity, the specimen is exposed to both these conditions several times. The gas-tightness of the clamping unit is verified by a voltage drop test.

In other test procedures, products are exposed to a dry corrosive gas atmosphere containing sulfide, nitrogen and sulfur oxides or chloride gas. These tests can be performed over a period of four to 21 days.

• Salt Spray Test per IEC/EN 60068-2-11; DNV GL, LR (Marine Applications)

This test is similar to the test performed in water condensation alternating atmospheres, except that instead of industrial atmospheres, salt mist conditions will be simulated in a heated test chamber (see picture).

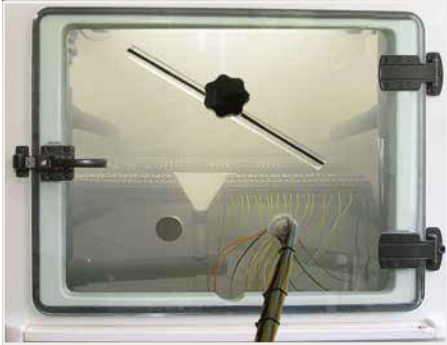

Depending on the test procedure being used, the test specimen is sprayed with salt mist for 16 hours up to 672 hours (4 weeks). Salt spray tests are widely used, especially for marine approvals. However, this test is performed differently than the test procedures described previously for general applications: During a typical test, the test specimen is sprayed with a salt solution for two hours and is then stored for seven days in an atmosphere with a relative humidity between 90 and 95%. This procedure is repeated four times. Voltage drop measurements are used as an evaluation criterion.

• Quick Change of Temperature per IEC/EN 60068-2-14

Without air-conditioning, distribution panels and terminal boxes are exposed to seasonal (and ever-changing) temperature extremes – especially on the open field side. In process technology, for example, a terminal block is exposed to even quicker changes in temperature.

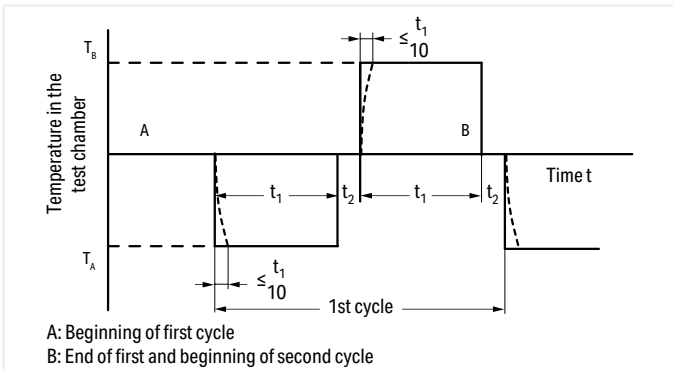

To simulate such conditions, the test specimen is exposed to repeated temperature changes, for example, between TA -40°C (-104°F) and TB +70°C (+158°F). The dwell time t1 depends on the thermal capacity of the test specimen and should be between maximum of 3 h and minimum of 10 min and the transition time t2 ... 3 min, 20 ... 30 s or less than 10 s. The mechanical and electrical properties of the product are checked at the end of the test.

• Damp Heat, Cyclic (12 + 12 Hour Cycle) per IEC/EN 60068-2-30, DNV GL, LR (Marine Applications)

This test determines the suitability of electrical equipment for use and storage under conditions of high relative humidity when combined with cyclic temperature changes and, in general, producing condensation on the surface of the specimen.

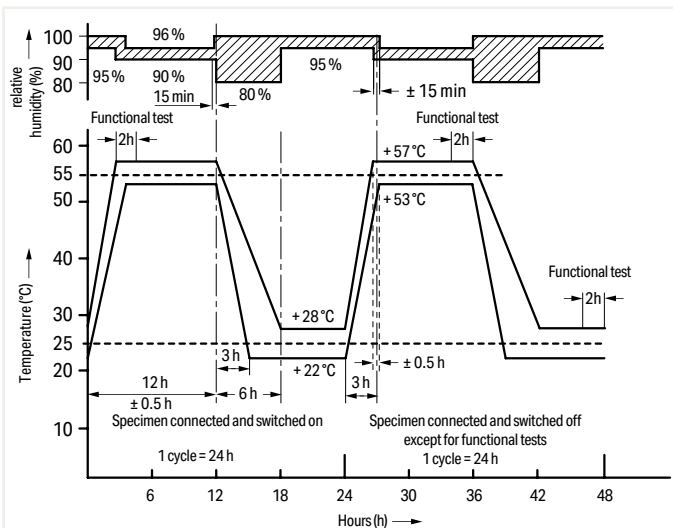

In addition to the salt spray tests, the damp heat test is also used for marine approvals. For this test, the specimens are subjected to temperatures varying cyclically between +25°C (+77°F) and +55°C (+131°F) with a relative humidity of 95% (for tolerances see figure). Functional tests are performed at defined times during the storage period. The mechanical and electrical properties of the product are checked at the end of the test.

## UL Specifications – Underwriters Laboratories, USA

WAGO's terminal blocks and connectors are tested by Underwriters Laboratories Inc. according to one or more of the relevant following UL standards:

- |  |            |   |
|--|------------|---|
| <ul style="list-style-type: none"> <li>• PCB terminal strips (e.g., 236, 745 Series) are approved as non-stand-alone components per UL 1059 in connection with UL 486E.</li> </ul>   | UL 1059    | Standard for terminal blocks  |
| <ul style="list-style-type: none"> <li>• The <i>MULTI CONNECTION SYSTEM "MCS-MIDI"</i> is approved as terminal blocks per UL 1059 standard in connection with UL 486 E. It is therefore defined for field and factory wiring with at 300 V.</li> </ul>                   | UL 486 E   | Equipment wiring terminals for use with aluminum and/or copper conductors       |
| <ul style="list-style-type: none"> <li>• It is also approved as connectors for use in data, signal, control and power applications per UL 1977 for factory wiring at 600 V (i.e., the clamping unit must be wired under controlled manufacturing conditions).</li> </ul> | UL 1977    | Component connectors for use in data, signal, control and power applications    |
| <ul style="list-style-type: none"> <li>• Ex e II terminal blocks are approved to UL 60079-7.</li> </ul>  | UL 60079-7 | Electrical apparatus for explosive gas atmospheres – Part 7: Increased safety   |
| <ul style="list-style-type: none"> <li>• Insulation materials are tested for flammability and performance per UL 94.</li> </ul>  | UL 94      | Tests for flammability of plastic materials for parts in devices and appliances |

## Tests and Testing Procedures per UL Standards

All WAGO products meet requirements for the following tests:

- Pull-Out Test per UL 1059, UL 486 E

In this test, the connected conductors are subjected to the appropriate pull-out forces specified in the following table without jerking for a period of one minute.

Conductor Size AWG or kcmil		Pull-Out Force, Pounds (N)			
		UL 486 E, Table 22			
		Copper		Aluminum	
	(mm <sup>2</sup> )				
30	(0.05)	0.5	(2.2)	-	-
28	(0.08)	1	(4.5)	-	-
26	(0.13)	2	(8.9)	-	-
24	(0.2)	3	(13.4)	-	-
22	(0.32)	4.5	(20)	-	-
20	(0.52)	6.75	(30)	-	-
18	(0.82)	6.75	(30)	-	-
16	(1.3)	9	(40)	-	-
14	(2.1)	11.5	(50)	-	-
12	(3.3)	13.5	(60)	10	(44)
10	(5.3)	18	(80)	10	(44)
8	(8.4)	20.5	(90)	10	(44)
6	(13.3)	21	(94)	28	(124)
4	(21.2)	30	(133)	36	(160)
3	(26.7)	35	(156)	42	(187)
2	(33.6)	42	(186)	50	(222)
1	(42.4)	53	(236)	61	(271)
1/0	(53.5)	64	(285)	72	(320)
2/0	(67.4)	64	(285)	78	(347)
3/0	(85.0)	79	(351)	97	(432)
4/0	(107)	96	(427)	116	(516)
250	(127)	96	(427)	116	(516)
300	(156)	99	(441)	116	(516)

Test Arrangement per  
UL 1059, UL 486 E:

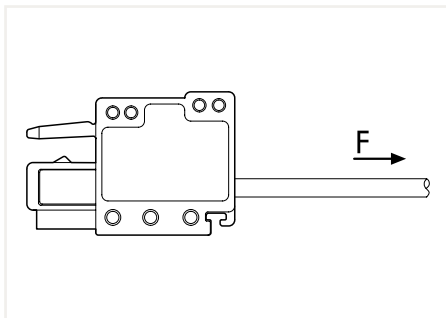

## UL Specifications – Underwriters Laboratories, USA (continued)

### Tests and Testing Procedures per UL Standards (continued)

#### • Heat Cycling Test per UL 1059, UL 486 E

Test performed per:

**UL 1059**

**per UL 486 E**

(Equipment wiring terminals)

Test performed with maximum rated cross section

Test performed with maximum rated cross section

Test current: 150% of maximum rated current

Test current: Increased test current per  
UL 486 E, Table 4

84 cycles of: 3 1/2 h ON / 1/2 h OFF

500 cycles of: 1 h ON / 1 h OFF  
1 1/2 h ON / 1 1/2 h OFF  
(from 4/0 AWG up to 400 kcmil per UL 486 E)

The temperature rise is measured after the first and the 84th cycle.

The temperature rises at the terminal blocks and control conductors are measured and recorded after: 1, 25, 50, 75, 100, 125, 175, 225, 275, 350, 425 and 500 cycles.

The temperature rise must not exceed 5°C (41°F) after the 84th cycle, compared to the temperature measured after the first cycle.

The temperature rise must not exceed 125°C (257°F) and the stability factor "S" must not exceed ±10.

Conductor Size		Test Current for Copper Conductors in A						
		UL 486 E, Table 4						
AWG or kcmil	(mm <sup>2</sup> )	Assigned Maximum Ampere Rating <sup>b</sup>	Static Heating <sup>a,c,g</sup>	Heat Cycling Temperature Rating <sup>a</sup>				
				75°C (167°F) <sup>d,g</sup>	90°C (194°F) <sup>e,g</sup>			
30	(0.05)	-		3		3.5		4
28	(0.08)	-		3.5		4		5
26	(0.13)	-		5.5		6		8
24	(0.2)	-		7		8		10
22	(0.32)	-		9		12		13
20	(0.52)	-		12		16		17
18	(0.82)	-		17		19		24
16	(1.3)	-		18		20		31
14	(2.1)	15	[20]	30	[22]	33	[27]	40
12	(3.3)	20	[25]	35	[28]	39	[40]	54
10	(5.3)	30	[40]	50	[45]	56	[60]	75
8	(8.4)	50		70		80		100
6	(13.3)	65		95		105		131
4	(21.2)	85		125		140		175
3	(26.7)	100		145		165		205
2	(33.6)	115		170		190		240
1	(42.4)	130		195		220		275
1/0	(53.5)	150		230		255		320
2/0	(67.4)	175		265		300		370
3/0	(85.0)	200		310		345		435
4/0	(107)	230		360		405		505
250	(127)	255		405		445		565
300	(152)	285		445		500		625

<sup>a</sup> See Section 7.2, 8.2 and 9.2 (UL 486 E)

<sup>b</sup> Values are for 75°C (167°F), not more than three conductors in raceway or cable ampacities, National Electric Code, ANSI/NFPA 70.

<sup>c</sup> Values are for 75°C (167°F) single conductors in free air ampacities, National Electric Code, ANSI/NFPA 70.

<sup>d</sup> Values are approximately 112% of the static heating test currents.

<sup>e</sup> Values for 8 AWG and larger conductors are approximately 140% of the static heating test currents.

<sup>f</sup> See Section 9.2.4

<sup>g</sup> Values in parentheses apply to connectors with assigned ampere ratings.

- **Conditioning – Temperature-Rise Rest per UL 1059**

Test performed per:

**per UL 1059** (terminal blocks)

**Conditioning:**

The clamping units are **pre-wired/pre-inserted nine times** using a conductor with maximum rated cross section. At the 10th time, a new conductor is connected.

After this, a static heating test is performed.

**Static Heating Test:**

Test current: Terminal block rated current

Test duration: 30 days

Max. permissible temperature rise: 30°C (86°F)



## UL Specifications – Underwriters Laboratories, USA (continued)

### Tests and Testing Procedures per UL Standards (continued)

#### • Insulation Parameters per UL 1059

The table below shows the potential involved and the corresponding clearances and creepage distances required in different applications.

Table 8.1 – Minimum Acceptable Spacing for Terminal Blocks per UL 1059 Standard

Application:	Potential In- volved in Volts	Spacing in inches (mm) between un- insulated live parts of opposite po- larity, un-insulated live parts and un- insulated grounded parts other than the enclosure			
		Through Air		Over Surfaces	
A. Dead-front switchboards, panelboards, service equip- ment and similar applications	51 ... 150 151 ... 300 301 ... 600	1/2 (12.7) 3/4 (19.1) 1 (25.4)	3/4 (19.1) 1-1/4 (31.8) 2 (50.8)		
B. Commercial appliances, including business equip- ment, electronic data pro- cessing equipment and simi- lar applications	51 ... 150 151 ... 300 301 ... 600	1/16 <sup>a</sup> (1.6) <sup>a</sup> 3/32 <sup>a</sup> (2.4) <sup>a</sup> 3/8 (9.5)	1/16 <sup>a</sup> (1.6) <sup>a</sup> 3/32 <sup>a</sup> (2.4) <sup>a</sup> 1/2 (12.7)		
C. Industrial, general	51 ... 150 151 ... 300 301 ... 600	1/8 <sup>a</sup> (3.2) <sup>a</sup> 1/4 (6.4) 3/8 (9.5)	1/4 (6.4) 3/8 (9.5) 1/2 (12.7)		
D. Industrial, devices having lim- ited ratings <sup>b</sup>	51 ... 300 301 ... 600	1/16 <sup>a</sup> (1.6) <sup>a</sup> 3/16 <sup>a</sup> (4.8) <sup>a</sup>	1/8 <sup>a</sup> (3.2) <sup>a</sup> 3/8 (9.5)		
E. Terminal blocks rated 601 ... 1500 V <sup>c</sup>	601 ... 1000 1001 ... 1500	0.55 (14.0) 0.70 (17.8)	0.85 (21.6) 1.20 (30.5)		

Notes:

1 A slot, groove, or similar, 0.013 inch (0.33 mm) wide or less in the contour of the insulating material is to be disregarded.

2 Air space of 0.33 mm or less between a live part and an insulating surface is to be disregarded for the purpose of measuring over surface spacing.

<sup>a</sup> The spacing between terminal blocks of opposite polarity and the spacing between a terminal block and a grounded dead metal part shall not be less than 1/4 inch (6.4 mm) if short-circuiting or grounding of such terminal blocks may result from protruding wire strands.

<sup>b</sup> See Section 8.5 (UL 1059)

The spacing values indicated in sub-paragraph D in Table 8.1 are applicable to a terminal block for use only in or with industrial control equipment where the load on any single circuit of the terminal block does not exceed 15 A at 51 ... 150 V, 10 A at 151 ... 300 V, 5 A at 301 ... 600 V or the maximum ampere rating, whichever is less.

<sup>c</sup> Applies only to terminal blocks investigated to Part II of this standard. See Section 22.1 (UL 1059).

#### • Flammability Test per UL 94

This test provides an indication of the material's ability to extinguish a flame, once ignited.

Several ratings can be applied, based on the rated of burning, time to extinguish, ability to resist dripping, and after-glow extinguishing time. Each material tested may receive several ratings, depending on the wall thickness.

UL 94 Rating Categories:

##### V2

- Specimen mounted vertically
- Burning stops within 30 seconds after the flame is removed
- Flaming drips allowed
- After-glow extinguishes within 60 seconds max.

##### V1

- Specimen mounted vertically
- Burning stops within 30 seconds after the flame is removed
- No flaming drips allowed
- After-glow extinguishes within 60 seconds max.

##### V0

- Specimen mounted vertically
- Burning stops within 10 seconds after the flame is removed
- No flaming drips allowed
- After-glow extinguishes within 30 seconds max.

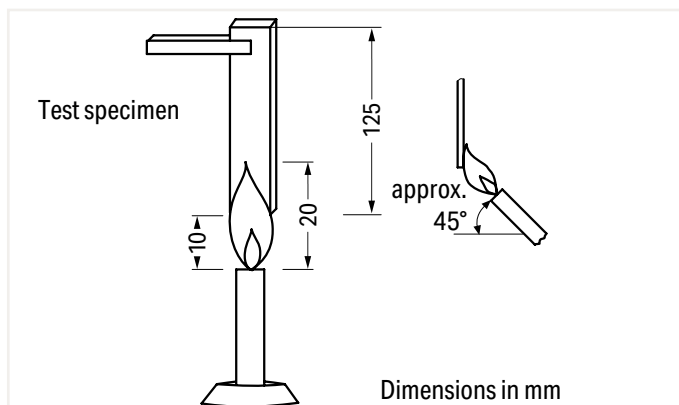

During the test, a 3/4 inch (20 ± 1 mm) flame is applied for two 10-second intervals to the specified bar specimen held vertically.

## "Alu-Plus" Contact Paste

### Terminating Aluminum Conductors

#### Terminating Aluminum Conductors

WAGO spring clamp terminal blocks are suitable for solid aluminum conductors ① up to 4 mm<sup>2</sup>/12 AWG if WAGO "Alu-Plus" Contact Paste is used for termination.

Advantages of the "Alu-Plus" Contact Paste:

- Automatically destroys the oxide film during clamping.
- Prevents fresh oxidation at the clamping point.
- Prevents electrolytic corrosion between aluminum and copper conductors (in the same terminal block).
- Provides long-term protection against corrosion.

Using terminal blocks with CAGE CLAMP® Spring Pressure Connection Technology, **aluminum conductors must first be cleaned with a blade** and then immediately be inserted into the clamping units filled with "Alu-Plus" Contact Paste.

It is also possible to apply WAGO "Alu-Plus" **additionally** on the whole surface of the aluminum conductor before termination.

Please note that the nominal currents must be adapted to the reduced conductivity of the aluminum conductors:

2.5 mm<sup>2</sup> (14 AWG) = 16 A  
4 mm<sup>2</sup> (12 AWG) = 22 A

WAGO "Alu-Plus" in the syringe offers a higher degree of reliability and cleanness when terminating solid aluminum conductors.

Filling is, for example, quickly performed on WAGO PCB Terminal Trips:

① Aluminum conductors per IEC 61545 standard, Class B, "Alloy 1370" with 90 ... 180 N/mm<sup>2</sup> tensile strength and 1 ... 4% elongation  
Standard values: 90 ... 180 MPa tensile strength, 1 ... 4% elongation (per EN 615.4.1)



WAGO Lighting Connectors

Push nozzle of the "Alu-Plus" syringe first into the circular entry and then into the square conductor entry hole of the WAGO Lighting Connector.



Press plunger down until the "Alu-Plus" has filled both entry holes.

**Note:** Not suitable for higher temperature applications!

# Material Specifications

## Soldering Information

### Wave Soldering

WAGO's PCB terminal blocks and connectors comply with the 2011/65/EU Directive of June 8, 2011 and display the "RoHS compliant" logo on their packaging.

In accordance with IEC 61760-1, the maximum double-wave soldering temperature is 260°C (500°F) for a maximum 10 seconds or 5 seconds per wave.

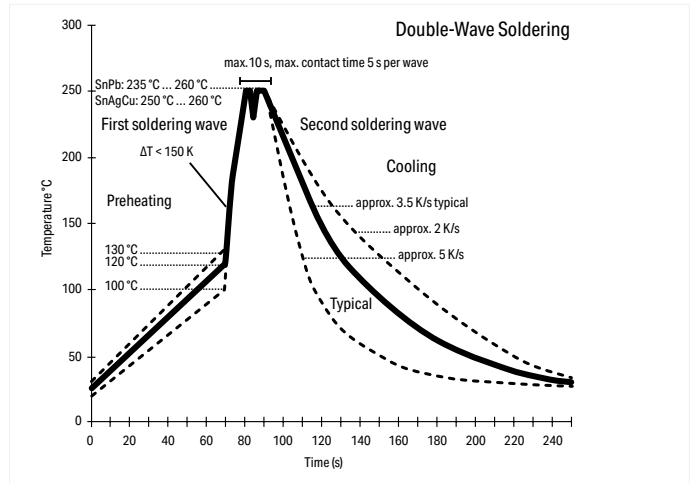

### Reflow Soldering

WAGO's THR and SMD PCB terminal blocks and connectors have high-temperature-resistant insulated housings and reflow solder contacts.

In accordance with IEC 61760-1 or IEC 60068-2-58, the maximum soldering temperature is 260°C/500°F (peak temperature). Due to customer-specific variables (e.g., component configuration and orientation, type of soldering machine, solder paste), trial runs are recommended to ensure product and process compatibility under actual manufacturing conditions.

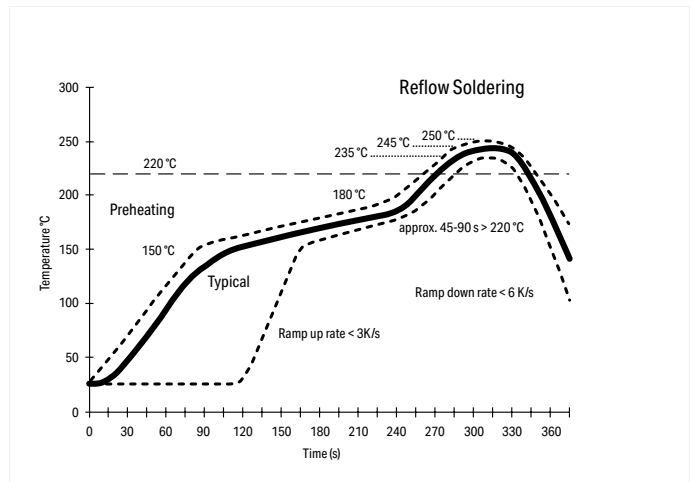

## Insulation Materials

WAGO primarily uses polyamide (PA 66 and PA 46) for housing current-conducting parts, as well as polyphthalamide (PPA) and polycarbonate (PC) for insulation material (see table). For more than 50 years, these materials have proven themselves in WAGO products and all are approved by certified, third-party agencies. All listed halogen-free and flame-retardant polymer materials do not contain any heavy metals, silicone, asbestos, or formaldehyde as formulation components.

Table: Standard Insulation Materials

Material	PA 66	PA 66 GF	PPA GF	PA 46	PC	PC
Flammability	V0	V0	V0	V2	V2	V0
UL 94 flammability test ratings	V0	V0	V0	V2	V2	V0
Oxygen Index (OI) per EN ISO 4589-2	> 32 %	> 33 %	> 37 %	> 27 %	> 26 %	> 35 %
Glow-wire test per IEC 60695-2-12 GWFI*	850 °C	850 °C	850 °C	750 °C	800 °C	960 °C
IEC 60695-2-13 GWIT*	775 °C	775 °C	775 °C	725 °C	850 °C	850 °C
Comparative Tracking Index (CTI) per IEC 60112	600 V	600 V	600 V	375 V	225 V	225 V
Temperature of the ball indentation hardness test per IEC 60695-10-2	≥ 125 °C	≥ 175 °C	≥ 225 °C	n.s.**	≥ 125 °C	≥ 125 °C
RTI impact per UL 746B	105 °C	100 °C	115 °C	115 °C	125 °C	120 °C
Heat deflection temperature (HDT/B) per ISO 75 (bending stress A*: 1.8 MPa; B: 0.45 MPa)	215 °C	235 °C	285 °C	280 °C	130 °C (1.8 MPa)	130 °C (1.8 MPa)
Surface resistivity per IEC 60093	10 <sup>12</sup> Ω	10 <sup>12</sup> Ω	10 <sup>15</sup> Ω	10 <sup>13</sup> Ω	10 <sup>15</sup> Ω	10 <sup>15</sup> Ω
Specific contact resistance per IEC 60093	10 <sup>15</sup> Ω/cm	10 <sup>15</sup> Ω/cm	10 <sup>13</sup> Ω/cm	10 <sup>13</sup> Ω/cm	10 <sup>11</sup> Ω/cm	10 <sup>13</sup> Ω/cm
Dielectric strength per IEC 60243-1	30 kV/mm	40 kV/mm	25 kV/mm	25 kV/mm	25 kV/mm	29 kV/mm

\*Value depends on wall thickness, EN 60335 compliance upon request; \*\*n. s. = not specified

**Polyamide (PA 66)**

WAGO uses modified, halogen-free, flame-retardant polyamides.

These materials do not corrode, are difficult to ignite and feature self-extinguishing properties (V0 rating per UL 94).

Adhering to UL 746C, the polyamides used at WAGO have a continuous operating temperature of 105°C (221°F) based on the relative temperature index with impact load (RTIimp). This ensures that the necessary electrical and mechanical insulating properties are maintained at a sufficiently guaranteed level over a long period of time.

The short-term upper temperature limit is 200°C (392°F).

In lower temperature ranges, it has been determined that no damage to the insulation material occurs during usage down to -35°C (-31°F). After installation and wiring, WAGO products can even be used at temperatures down to -60°C (-76°F).

Environmental humidity (up to 2.5% in a standard atmosphere) is absorbed, providing the polyamides with optimum elasticity, strength and durability.

In practical use, basic stabilization of WAGO's polyamides has been proven over many years to be sufficient to prevent damage caused by ozone or UV radiation exposure in intended applications.

Polyamides have excellent resilience against the most demanding climates and have proven themselves in tropical applications worldwide. Insulation parts made of polyamide are resistant to insects. The material does not provide oxygen or other biogenic elements to microorganisms.

The presence of anaerobic earth bacteria, mold, fungus and enzymes does not degrade the material.

Polyamides are resistant to most fuels, greases, and oils, as well as the most commonly used cleaners, such as alcohol, Freon, Frigen, and carbon tetrachloride. Acid resistance depends on the acid type and concentration, as well as the exposure time.

The use of insulation materials during in-house production at WAGO only occurs after acceptance of factory test certificates and specified material tests.

**Glass Fiber-Reinforced Polyamide (PA 66 GF)**

WAGO uses glass-fiber-reinforced polyamides for components with increased mechanical demands, such as levers, push-buttons or housings exposed to high stress, because they have significantly better mechanical characteristic properties than non-reinforced polyamides.

In general, materials are used that have excellent tracking resistance, flammability ratings and high temperature resistance.

More data can be found in the table.

**Polyphthalamide (PPA GF)**

Glass-fiber-reinforced, high-performance polyamides are ideal for high-temperature applications, due to the material's high level of thermal dimensional stability, its low dependence on ambient conditions and its excellent strength properties. The material's outstanding tracking resistance permits short creepage distances to be incorporated into miniature components. Fire protection equipment enables classification in flammability class V0 per UL 94 – even for extremely thin walls. PPA GF absorbs minute amounts of moisture from the atmosphere making it ideal for reflow soldering applications and for thin-walled, dimensionally stable components.

More data can be found in the table.

**Polyamide (PA 46)**

In comparison with PA 66, PA 46 has substantially higher dimensional stability under heat. The relative temperature index with impact load (RTIimp) is 115°C (239°F) for PA 4.6. The permissible short-term temperature for the type used by WAGO is 280°C (536°F).

More data can be found in the table.

**Polycarbonate (PC)**

Polycarbonate has excellent dimensional stability under heat. The electrical and mechanical properties remain intact at extremely high temperatures up to approximately 120°C (248°F) per UL Yellow Card. Its excellent electrical insulating properties and dimensional stability are virtually independent of environmental conditions, such as humidity and temperature. Highly precise components can be created due to the low shrinkage of the material during injection molding. Polycarbonate has excellent weather resistance and is also highly resistant to high energy radiation. If the PC is not colored, then the components are glass-clear.

Thanks to its desirable properties (e.g., dimensional stability, heat resistance, non-flammability, durability and transparency), PC is a proven and widely used material in the electrical industry.

Depending on the demands placed on the finished product, WAGO uses polycarbonates that carry flammability classifications V2 and V0 per UL 94.

Medium-viscosity PC is used that features excellent chemical resistance.

## Material Specifications

### Contact Materials

Hard and extra-hard electrolytic copper (ECu), as well as extra-hard copper alloys are the standard materials used for the current-carrying parts of all WAGO products.

These materials combine excellent conductivity and good chemical resistance without the risk of stress-induced cracking.

### Contact Materials

The special tin layer, which is the standard layer for all current-carrying parts in WAGO products, ensures perfect long-term protection against corrosive substances. Furthermore, these layers provide a gas-tight contact that ensures a durable transition resistance.

At the clamping unit, the conductor is embedded into the soft tin layer via high contact pressure. This protects the contact area against corrosion.

The thick tin layer also ensures good solderability of both PCB terminal block and connector solder pins.

### Clamping Spring Material

Every WAGO clamping spring is made of high-quality, accurately tested austenitic chrome nickel steel (CrNi) with high tensile strength, which boasts proven corrosion resistance through long-term usage.

It is resistant to sea spray, city pollutants and industrial emissions (e.g., sulfur dioxide, hydrogen sulfide).

At room temperatures of approximately 20°C (68°F), the material is resistant to salt solutions up to 30% and dilute phosphoric acids up to 30%.

Even after decades of use, no galvanic corrosion between the chrome nickel spring steel (in connection with the contact materials used by WAGO) and the connected copper conductors has been detected.

The relaxation of the material as a function of time and surrounding temperatures up to 105°C (221°F) can be ignored. Samples loaded with 500 N/mm<sup>2</sup> at a temperature of 250°C (482°F) showed a relaxation of only 1.5%.

In certain product lines, the clamping springs are thermally treated at temperatures between 350°C (662°F) and 420°C (788°F) after production.

This treatment reduces internal stress due to the material's mechanical deformation, which may result in a slight brown discoloration of the spring surface.

WAGO only accepts deliveries of chrome nickel spring steel against certificates of conformity and after select material tests have been performed.

## General Technical Information on Electrical Equipment Used in Hazardous Areas

The formation of an explosive atmosphere is required for the existence of a potentially explosive hazard. Such an atmosphere can be produced at any location where flammable gases or liquids are manufactured, processed, transported and/or stored.

Such hazardous areas can be found in a wide range of industries, including chemical plants, refineries, power plants, paint production facilities, painting shops, filling stations, vehicles, sewage treatment plants, airports, grain mills or harbor facilities.

### THE FOLLOWING APPLIES AS A GUIDELINE FOR THE UNDERLYING PRINCIPLE FOR EXPLOSION PROTECTION:

#### General Requirements

The European EN 60079-0 Standard – VDE 0170-1 Classification – contains general requirements for the design and testing of electrical equipment to be used in hazardous areas.

This ensures this equipment does not cause an explosion in the surrounding atmosphere. EN 60079-0 is supplemented or revised by the European standards indicated on the right which refer to the specifically standardized types of protection.

#### Electrical Equipment

Electrical equipment includes all items used in whole or in part with electricity. This includes items for generation, transport, distribution, storage, measurement, control, conversion and consumption of electrical power, as well as telecommunications.

#### Ex Components

Ex components are elements of electrical equipment for hazardous areas that are marked with the "U" letter. These components must not be used on their own in such areas and require an additional certificate when used in such areas when installed in the electrical equipment.

#### Ignition Protection Categories

Only explosion-proof (protected) equipment must be used in areas in which an explosive atmosphere may still be expected despite the implementation of prevention measures. Explosion-protected electrical equipment can have various types of protection in accordance with the EN 60079 standard requirements.

Protection used by the manufacturer essentially depends on the type and function of the apparatus. From a safety point of view, all standardized types of protection should be viewed as equal.

The ignition protection category "n" exclusively describes the use of explosion-protected electrical components in Zone 2. This zone includes areas in which hazardous, potentially explosive atmospheres are likely to occur rarely or short-term. This represents a transition between Zone 1, in which explosion protection is required, and the safe area in which, for example, welding may be performed at any time.

Regulations covering these electrical components are being prepared worldwide. Organizations such as KEMA in the Netherlands, or PTB in Germany certify that the devices meet the requirements of the EN 60079-15 standard.

Ignition protection category "n" also requires that electrical equipment be provided with additional ID markings as follows:

- nA – non-sparking
- nC – enclosed-break, hermetically sealed, non-incendive, sealed
- nR – restricted-breathing

The table on the opposite page shows an overview of the standardized ignition protection categories and describes their basic principle, as well as typical applications.



## General Technical Information on Electrical Equipment Used in Hazardous Areas

### Continued

#### Hazardous Areas

Hazardous areas are zones in which the atmosphere may become explosive. An explosive atmosphere is a mixture of flammable substances in the form of gases, vapors or mixtures with air under atmospheric conditions in critically mixed ratios such that excessive high temperature, arcs or sparks may cause an explosion.

EN 60079-10-1/EN 60079-10-2 and all other well-known standards rank hazardous areas according to the likelihood of the occurrence of an explosive atmosphere into the following zones:

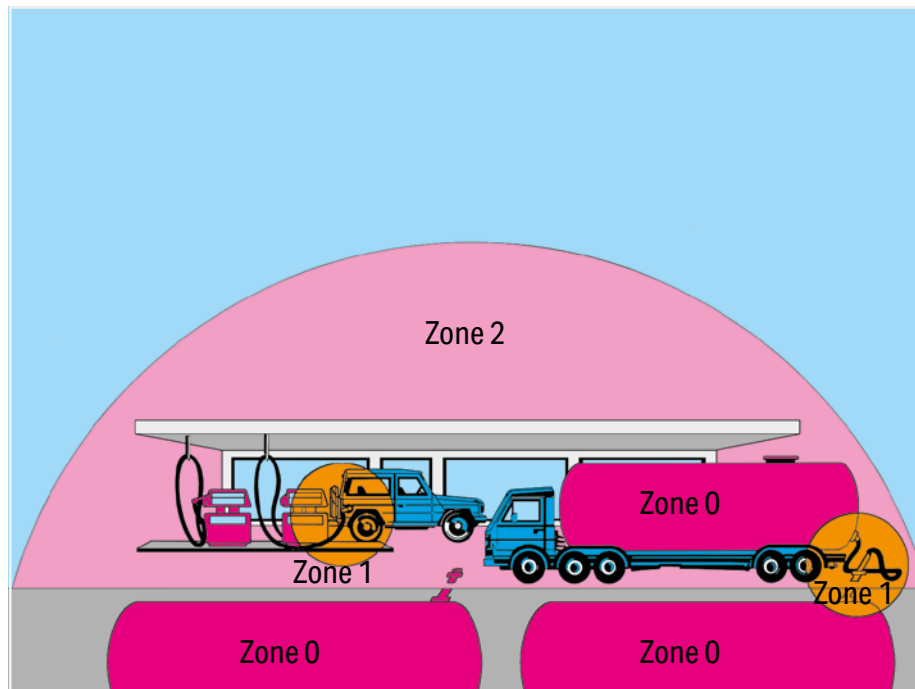

Hazardous areas due to explosive gases, vapors and mists:

#### Zone 0

Area in which an explosive gas atmosphere is present continuously, for long periods or frequently.

#### Zone 1

Area in which an explosive gas atmosphere is likely to occur periodically or occasionally during normal operation.

#### Zone 2

Area in which an explosive gas atmosphere is unlikely to occur during normal operation; if it does occur, then it is temporarily.

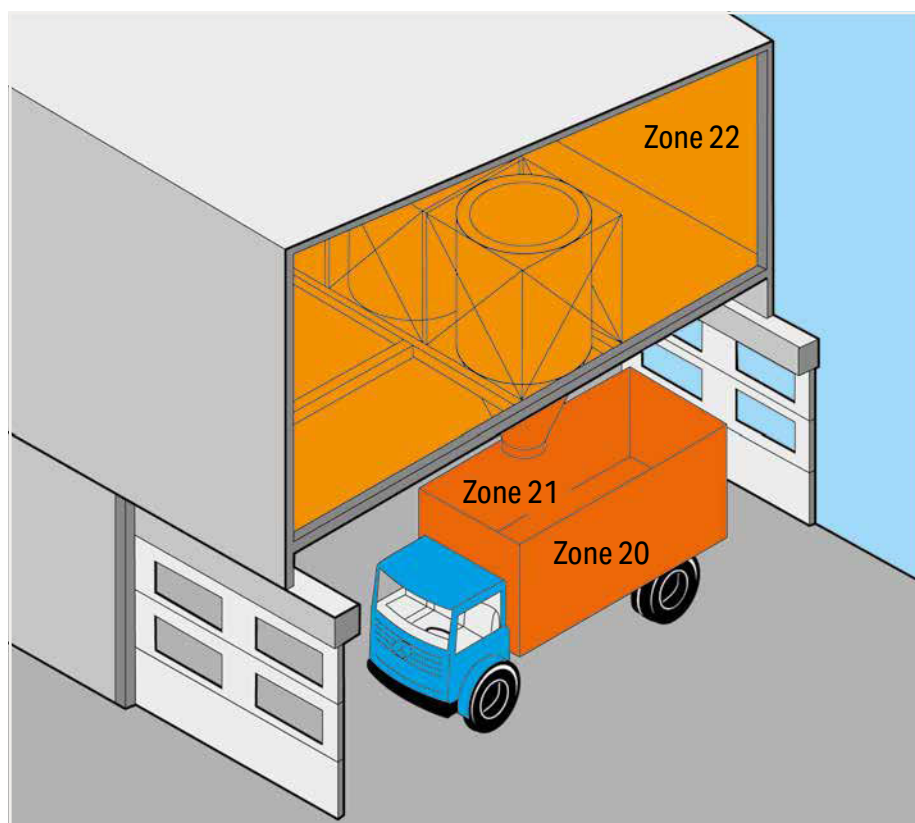

Hazardous areas due to explosive dust/air mixtures:

#### Zone 20

Area in which an explosive dust atmosphere due to dust/air mixtures is present continuously, for long periods or frequently.

#### Zone 21

Area in which an explosive dust atmosphere due to dust/air mixtures is likely to occur occasionally during normal operation.

#### Zone 22

Area in which an explosive dust atmosphere due to flammable dust/air mixtures is unlikely to occur during normal operation; but if it occurs, then only for a short period of time.



EN 60079-0 also classifies electrical equipment for use in hazardous areas into two groups:

**Group I:**

Electrical equipment for mines susceptible to firedamp

**Group II:**

Electrical equipment for hazardous areas, except for mines susceptible to firedamp.

As this broad application range encompasses a large number of potentially flammable gases, Group II is broken down into sub-groups IIA, IIB and IIC.

This breakdown is based on different gases/materials exhibiting differing ignition power levels as parameters. Therefore, representative gases have been allocated to these three sub-groups:

- IIA – Propane
- IIB – Ethylene
- IIC – Hydrogen

WAGO's terminal blocks can be used both in Group I and Group II.

This information is given under Item 12 in the EU Prototype Test Certificates, based on which the terminal blocks have been approved for Group I and Group II.

Temperature Class	Maximum Surface Temperature (°C)
T1	450
T2	300
T3	200
T4	135
T5	100
T6	85

Depending on the maximum surface temperature, electrical equipment in Group II are classified in temperature categories T1 to T6 for all protection types. The surrounding air temperature, which must be accounted for in dimensioning, is defined as 40°C/104°F (deviations are acceptable under some conditions).

Terminal blocks for "eb" (increased safety) protection type are generally assigned to temperature category T 6. When rail-mount terminal blocks are used in equipment of temperature categories T1 to T5, ensure that the highest temperature on the insulating parts does not exceed 85°C (185°F). The highest measured surface temperature rise must not exceed 40 K.

Thermal resistance of the insulation material must be at least 20°C (68°F) greater than the highest operating temperature. Low temperature stability is considered to be sufficient when the insulation material can withstand 24-hour storage at a temperature of -60°C (-76°F) without nullifying the type of protection.

**Special Requirements  
"Increased Safety Ex e"**

The European EN 60079-7 Standard – VDE 0170-6 Classification – contains special requirements for the design and testing of electrical equipment with "eb" (increased safety) protection type for use in hazardous areas.

This standard is a supplement to EN 60079-0 and applies to equipment or parts thereof that neither generate sparks or arcing under normal operating conditions, nor exhibit hazardous temperatures.

This standard describes special measures, which have to be observed to obtain a safety degree according to the "eb" (increased safety) protection type.

Ex components such as rail-mount terminal blocks are covered by Section 4.2 "Terminal Blocks for External Conductors":

- The terminal blocks must be installed in an enclosure meeting the requirements of a recognized protection type per EN 60079-0, Section 1 or EN 60079-31.
- When installing the terminal blocks in an enclosure of protection type "eb" (increased safety) per EN 60079-7, the clearances and creepage distances of Table 2 must be observed. When using accessories, the installation instructions of the manufacturer must be observed.
- The terminal blocks can be used both in Group II and Group I, as the standard requirements are identical in this case.
- The use of this component requires a new assessment by a notified certification agency.

**Minimum Ignition Power of Typical Gases:**

Explosion Group	I	IIA	IIB	IIC
Gas	Methane	Propane	Ethylene	Hydrogen
Ignition Power	280	250	82	16

The following are the most important design requirements for terminal blocks for external supply conductors to electrical equipment: These must:

- be sufficiently large to permit reliable connection of external supply conductors with cross section of at least the size required by the nominal current of the equipment
- be protected against self-loosening and designed such that the supply conductors cannot slip out of their clamping units
- be designed such that adequate contact pressure is ensured without damaging the conductors
- be designed such that their contact pres-

sure does not change with temperature cycling

- be equipped with a spring connecting link for the connection of stranded conductors
- be designed so as to allow secure connection of smaller conductors for terminal blocks up to 4 mm<sup>2</sup> (12 AWG).

# General Technical Information on Electrical Equipment Used in Hazardous Areas

## Continued

Classification of insulation materials according to their tracking resistance is based on their Comparative Tracking Index (CTI) and is defined in Table 1 as follows:

This classification applies to insulating parts without ribs or grooves.

If the insulating parts have ribs or grooves sufficiently large to be considered, the minimum creepage distances must be set according to values for the insulation materials in the next-higher level (e.g., Group I, instead of Group II).

Accounting for the surrounding air temperature of 40°C (104°F) specified for electrical equipment, the current-carrying capacity of rubber-insulated conductors is reduced to 82%, based on DIN VDE 0298-4:2013-06, Table 12 and to 87% for PVC-insulated conductors for the current-carrying capacity defined for 30°C (86°F) in accordance with DIN VDE 0298-4:2013-06, Item 4.3.3.

### Conductor Types and Conductor Preparation

In accordance with EN 60079-14/DIN VDE 0165-1, the ends of stranded and fine-stranded conductors must be protected against splaying (e.g., via cable lugs or ferrules) or by the type of terminal blocks used. Soldering alone is not sufficient.

According to EN 60069-7/DIN VDE 0170-6, connecting electrical equipment to terminal blocks having an "eb" (increased safety) protection type must not lead to a reduction of the clearances and creepage distances.

Based on experience through the application of terminal blocks in aggressive atmospheres in the chemical industry, WAGO recommends gas-tight tinned copper ferrules or tinned copper pin terminals when connecting fine-stranded conductors to terminal blocks

**Table 1– Tracking Resistance for Insulation Materials**

Material Group	Comparative Tracking Index
I	600 ≤ CTI
II	400 ≤ CTI < 600
III a	175 ≤ CTI < 400
III b	100 ≤ CTI < 175

in corrosive atmospheres.

**Table 2– Minimum Creepage Distances/Clearances and Isolations**

Voltage (see <sup>a</sup> and <sup>b</sup> ) RMS Value for AC or DC Voltage V	Minimum Creepage Distance mm								Minimum Clearance and Isolations mm		
	Material Group								Clearance mm	Distance under Coating <sup>d</sup>	
	I		II		III a		III b				
	"eb"	"ec"	"eb"	"ec"	"eb"	"ec"	"eb"	"ec"	"eb"	"ec"	"ec"
≤ 10 (see <sup>c</sup> )	1.6	1	1.6	1	1.6	1	–	1	1.6	0.4	0.3
≤ 12.5	1.6	1.05	1.6	1.05	1.6	1.05	–	1.05	1.6	0.4	0.3
≤ 16	1.6	1.1	1.6	1.1	1.6	1.1	–	1.1	1.6	0.8	0.3
≤ 20	1.6	1.2	1.6	1.2	1.6	1.2	–	1.2	1.6	0.8	0.3
≤ 25	1.7	1.25	1.7	1.25	1.7	1.25	–	1.25	1.7	0.8	0.3
≤ 32	1.8	1.3	1.8	1.3	1.8	1.3	–	1.3	1.8	0.8	0.3
≤ 40	1.9	1.4	2.4	1.6	3	1.8	–	1.8	1.9	0.8	0.6
≤ 50	2.1	1.5	2.6	1.7	3.4	1.9	–	1.9	2.1	0.8	0.6
≤ 63	2.1	1.6	2.6	1.8	3.4	2	–	2	2.1	0.8	0.6
≤ 80	2.2	1.7	2.8	1.9	3.6	2.1	–	2.1	2.2	0.8	0.8
≤ 100	2.4	1.8	3	2	3.8	2.2	–	2.2	2.4	0.8	0.8
≤ 125	2.5	1.9	3.2	2.1	4	2.4	–	2.4	2.5	1	0.8
≤ 160	3.2	2	4	2.2	5	2.5	–	2.5	3.2	1.5	1.1
≤ 200	4	2.5	5	2.8	6.3	3.2	–	3.2	4	2	1.7
≤ 250	5	3.2	6.3	3.6	8	4	–	4	5	2.5	1.7
≤ 320	6.3	4	8	4.5	10	5	–	5	6	3	2.4
≤ 400	8	5	10	5.6	12.5	6.3	–	6.3	6	4	2.4
≤ 500	10	6.3	12.5	7.1	16	8	–	8	8	5	2.4
≤ 630	12	8	16	9	20	10	–	10	10	5.5	2.9
≤ 800	16	10	20	11	25	12.5	–	–	12	7	4
≤ 1000	20	11	25	11	32	13	–	–	14	8	5.8
≤ 1250	22	12	26	12	32	15	–	–	18	10	–
≤ 1600	23	13	27	13	32	17	–	–	20	12	–
≤ 2000	25	14	28	14	32	20	–	–	23	14	–
≤ 2500	32	18	36	18	40	25	–	–	29	18	–
≤ 3200	40	22	45	22	50	32	–	–	36	22	–
≤ 4000	50	28	56	28	63	40	–	–	44	28	–
≤ 5000	63	36	71	36	80	50	–	–	50	36	–
≤ 6300	80	45	90	45	100	63	–	–	60	45	–
≤ 8000	100	56	110	56	125	80	–	–	80	56	–
≤ 10000	125	71	140	71	160	100	–	–	100	70	–
≤ 12500	–	90	–	90	–	125	–	–	–	89	–
≤ 13640	–	98	–	98	–	138	–	–	–	97	–

<sup>a</sup> When determining the required values for creepage distances and clearances, the working voltage may be 1.1 times higher than the value in the table.

NOTE: The factor of 1.1 takes into account that in many places in a circuit the working voltage is equal to the rated voltage and that a number of rated voltages are used, which are covered by a factor of 1.1.

<sup>b</sup> The specified values for creepage distances and clearances already take into account a 10% tolerance for the highest supply voltage. Therefore, further considerations on the voltage fluctuations are unnecessary for determining which voltage value from the table should be used.

<sup>c</sup> CTI values are not applicable for voltages of 10 V or less. Materials that do not meet the requirements of material group III a can be used.

<sup>d</sup> The specified distances under consideration apply to printed circuit boards in protection level "ec" after 4.5.

It is expressly prohibited to use insulating parts for transferring contact forces. Terminal blocks with sharp edges which could damage supply lines and those types that can be rotated, turned or permanently deformed when fixed in place are not permitted for use. Terminal blocks for internal connections in electrical equipment must not be subjected to excessive mechanical stress.

These items must fulfill the requirements for terminal blocks used for external supply conductors.

Clearances between conductive parts having different potentials must be at least 3 mm for external connections, as specified in Table 2. The value of the creepage distances depends on the working voltage, surface geometry of the insulating parts and tracking resistance of the insulation material.

Grooves on the surface may only be considered if they are at least 2.5 mm deep and wide; ribs on the surface only if their height is at least 2.5 mm and their width corresponds to the mechanical strength of the material, however not smaller than 1 mm.

**Approvals**

Terminal blocks may be used in Zones 1 and 2, provided that the terminal blocks are accommodated in an enclosure that has a minimum IP54 protection and an Ex e certification.

Terminal blocks are considered to be Ex components because they are a part of the equipment. Part certificates provided by Ex Certification Agencies serve as a basis for issuing the complete conformity declaration for the unit.

An EC-type examination certificate is issued in accordance with the 2014/34/EU ATEX Directive.

In addition, an IEXEx Certificate may also be obtained from an appropriate, recognized certification agency in accordance with the IECEx Certification Agreement that is accepted throughout Europe and also in countries such as Canada, China and Australia. These certificates can also be viewed at: [www.iecex.com](http://www.iecex.com).

EC-type examination certificates have been granted to all WAGO terminal blocks listed in this catalog. WAGO terminal blocks approved for use in Ex e II areas are manufactured of flame-resistant, self-extinguishing Polyamide 66. The same applies to the terminal blocks used in non-hazardous areas. Tracking resistance with a CTI value of 600 as per IEC 60112 and a constant operating temperature of 105°C (22°F) in accordance with IEC 60216-1 and -2 are provided. Factory part quality tests are performed on all PCB terminal blocks with Ex e II approval to monitor and ensure the quality features described above.

**Terminal block marking per 2014/34/EU ATEX Directive:**

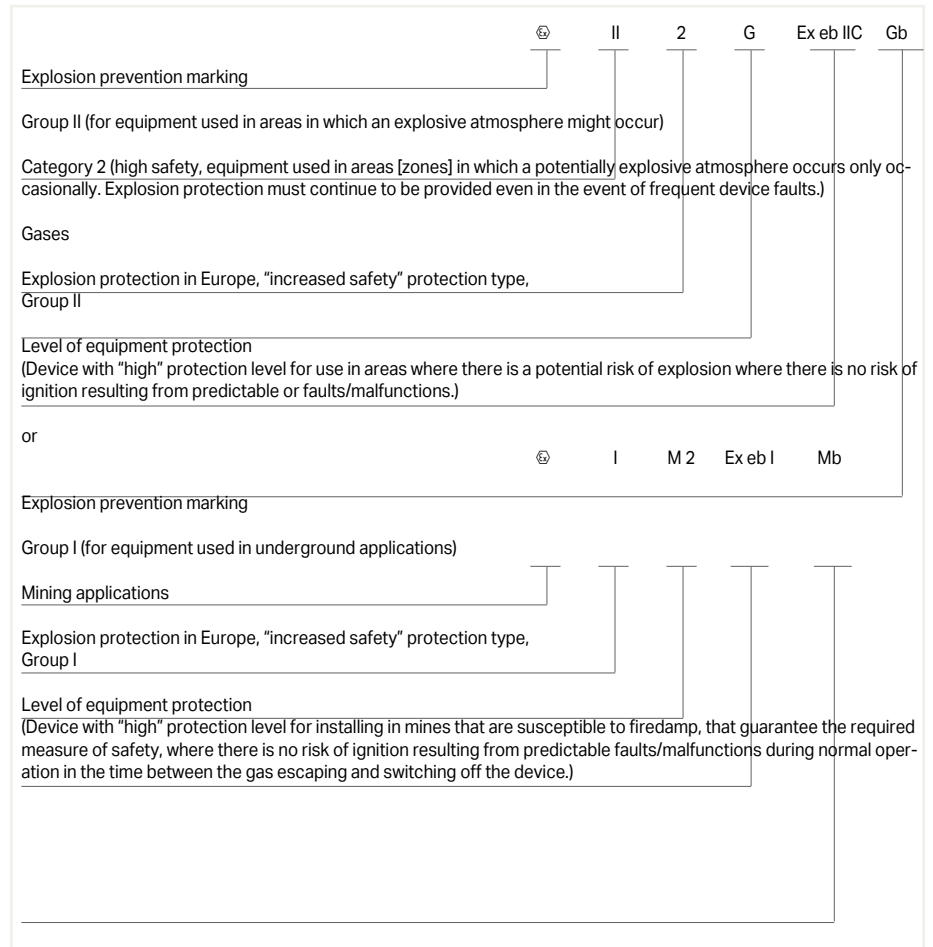

## General Technical Information on Electrical Equipment Used in Hazardous Areas

### Continued

#### Special Requirements

##### Equipment Protection by Intrinsic Safety "i"

The European EN 60079-11 Standard – Classification VDE 0170-7 – contains special requirements for the design and testing of electrical equipment with "i" (intrinsic safety) protection type for use in hazardous areas.

A circuit is "intrinsically safe" when, under normal operating conditions and in the event of specific fault conditions, no sparks or thermal effects can occur and cause the ignition of a certain explosive atmosphere.

A distinction is made here between:

- intrinsically safe electrical equipment when all circuits are intrinsically safe
- associated electrical equipment including both intrinsically and non-intrinsically safe circuits, and being designed such that the non-intrinsically safe circuits cannot affect the intrinsically safe ones.

Intrinsically safe electrical equipment and intrinsically safe parts of associated electrical equipment are classified at "ia", "ib" or "ic" protection level.

Electrical equipment classified Ex "ia" must not ignite when current is applied in the following cases:

- During fault-free operation, with those non-discreet faults present that result in the most adverse condition
- During fault-free operation and with a discreet fault, plus those non-discreet faults that result in unfavorable conditions
- During fault-free operation with two discreet faults, plus those non-discreet faults that result in the most adverse conditions.

Electrical equipment classified Ex "ib" must not ignite when current is applied in the following cases:

- During fault-free operation, with those non-discreet faults present that result in the most adverse condition;
- During fault-free operation and with a discreet fault, plus those non-discreet faults that result in unfavorable conditions.

At applied voltages, the intrinsically safe circuits in electrical equipment of protection level "ic" shall not be capable of causing ignition during undisturbed operation and under the conditions specified in this standard.

No special approval is required for terminal blocks used as simple electrical equipment for "Ex i" protection type, as they do not contain a voltage source and precise information is available concerning electrical data and temperature rise performance.

The terminal blocks must be identifiable, for example by their type designation, and the following design requirements must also be upheld:

Clearances and creepage distances between bare conductive parts of terminal blocks of separate intrinsically safe circuits and grounded or floating conductive parts shall be equal to or greater than the values given in Table 5 (see 654). If separate intrinsically safe circuits are to be considered, the air gap between bare conductive parts of the outer connection parts must meet the following requirements:

- at least 6 mm between the separate intrinsically safe circuits
- at least 3 mm from grounded parts, if a possible connection to ground has not been considered in the safety analysis. Each possible motion of metallic parts that are not rigidly secured must be considered.

**Terminal block marking must be unique and clearly visible. If a color is used for this, the color must be light blue (similar to RAL 5015).**

Note also when using terminal blocks:

Terminal blocks used for intrinsically safe circuits must be isolated from those used in non-intrinsically safe circuits. This is accomplished by several accepted methods. First, intrinsically safe circuits are separated by at least 50 mm of air space from non-intrinsically safe circuits.

Second, intrinsically safe circuits are housed in a separate enclosure. Third, intrinsically safe terminal blocks are separated from non-intrinsically safe terminal blocks by either an insulated partition or grounded metal partition. The partition size must allow for either 1.5 mm or less distance from the sides of the housing or provide at least 50 mm of creepage distance between the intrinsically and non-intrinsically safe circuits in all directions.

The insulation between an intrinsically safe and a non-intrinsically safe circuit has to withstand an effective AC voltage of  $2 \times$  nominal value (U) 1000 V or a minimum of 1500 kV, whereby U represents the total of the effective voltages of the intrinsically safe and the non-intrinsically safe circuit.

Short circuit between different intrinsically safe circuits could cause dangerous conditions. The insulation between these circuits should withstand an effective voltage of at least 500 VAC or 2 UAC where U is the total of the effective voltages of the related circuits.

In accordance with EN 60079-14/ DIN VDE 0165-1, in intrinsically safe circuits, the ends of stranded and fine-stranded conductors must be protected against splaying (e.g., via cable lugs or ferrules) or by the type of terminal blocks used. Soldering alone is not sufficient.

WAGO recommends gas-tight tinned copper ferrules or tinned copper pin terminals when connecting fine-stranded conductors to terminal blocks in corrosive atmospheres.

Requirements pertaining to the necessary distances as appropriate for use of the terminal blocks in the area DIN EN 60079-11 (VDE 0170-7) "Explosive atmosphere – Part 11: Device protection by intrinsically safe features "i" (IEC 60079-11)" are defined under Section 6.2 "Connecting point for external circuits," Section 6.2.1 "Terminal blocks." In general, the following can be stated for terminal blocks based on figure 1: "Example of isolated intrinsically safe terminal blocks with partition" in conjunction with figure 2: "Example of isolation of conductive parts," considering Table 5 – "Clearances, Creepage and Isolation Distances."

Outside:

a) Isolated intrinsically safe circuits: at least 6 mm

**All PCB terminal blocks listed on the ordering pages as suitable for Ex "i" applications fulfill these requirements.**

b) Intrinsically safe circuits and normal circuits (non-intrinsically safe):  $\geq 50$  mm

Inside:

a) Ex "i" to Ex "i"

b) Ex "i" to normal circuits

c) Ex "i" to ground

Based on Figure 2 and Table 5 (see next page) in accordance with the selected protection level and the special requirements for isolation distances as described in Sections 6.3.1 to 6.3.13, or in accordance with the alternative procedure for dimensioning of isolation distances given in Annex F.

Terminal blocks with smaller pin spacing may also be used for internal connections, provided they meet the requirements laid out in Table 5 (see below).

The exact clearances and creepage distances as well as separation distances based on Table 5 must be derived from the application items cited above.

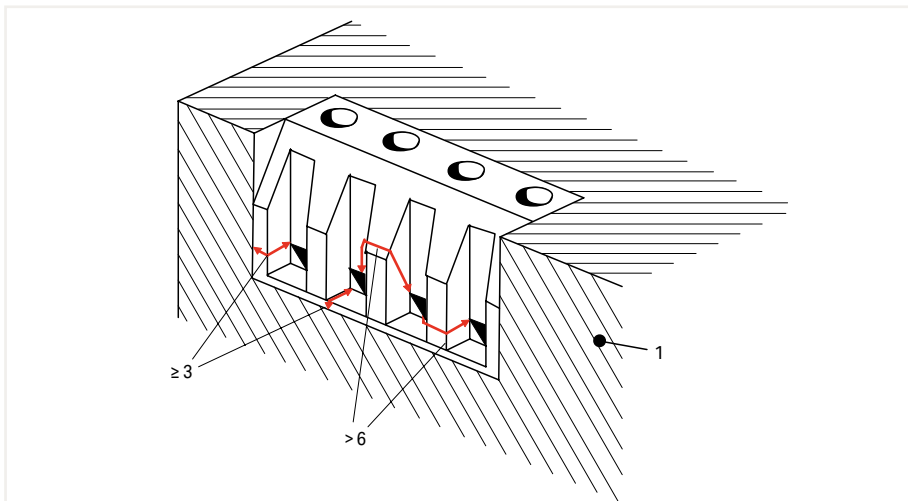
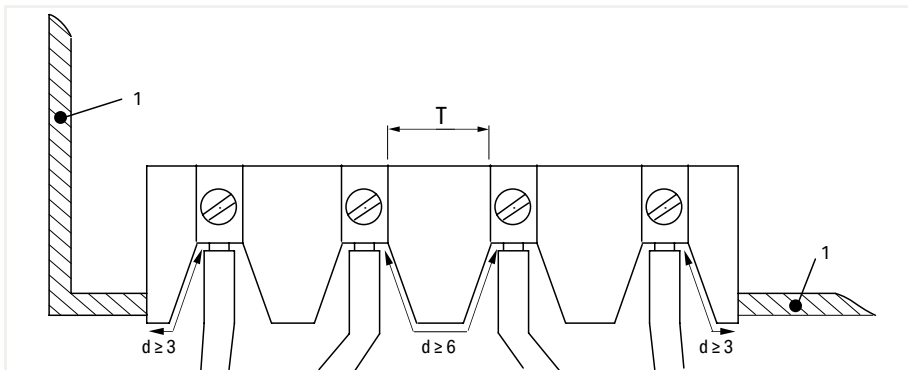

#### Legend:

- 1 Conductive cover
- T Distances based on Table 5
- d Distance at outer connecting parts of the terminal blocks according to 6.2.1

#### Note:

The dimensions indicated here represent the clearances and creepage distances around the insulation and not the thickness of the insulation.

Dimensions in mm

Figure 1a: Requirements for clearances and creepage distances for terminal blocks with isolated, intrinsically safe circuits



# General Technical Information on Electrical Equipment Used in Hazardous Areas Continued

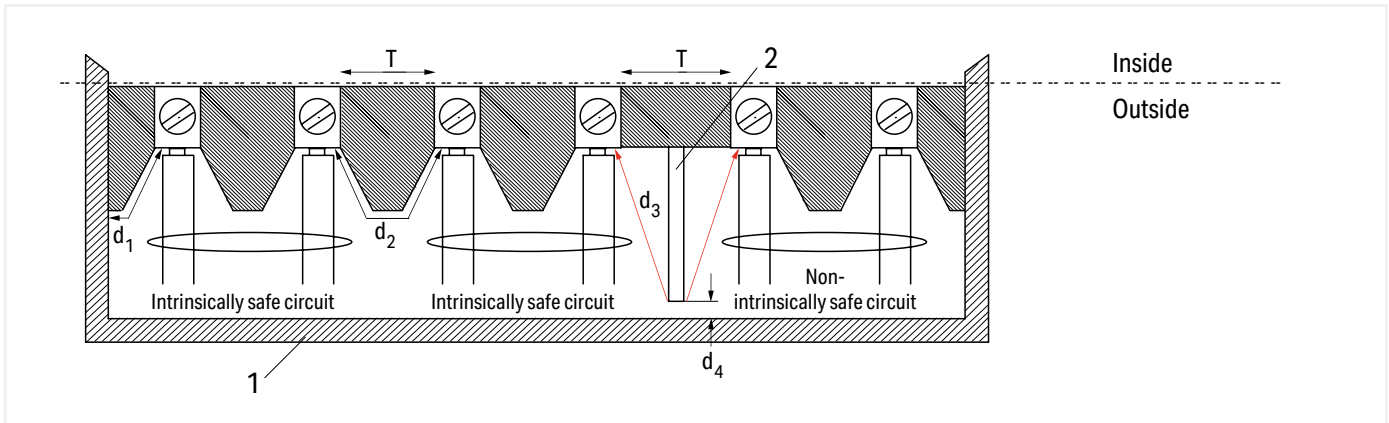

Figure 1b: Example of isolated intrinsically safe and non-intrinsically safe terminal blocks by a partition

**Legend:**

- 1 Cover: non-conductive or conductive and grounded
- 2 Partition based on 6.2.1 b); in this example, the partition must end at the base
- T Distances based on Table 5
- d1 ≥ 3 mm, when the cover is conductive and grounded
- d2 ≥ 6 mm
- d3 ≥ 50 mm or d4 ≤ 1.5 mm

**Note:**

The dimensions indicated here represent the clearances around the insulation and not the thickness of the insulation.

**Table 5 – Clearances, Creepage and Isolation Distances**

1 Voltage (Peak) (V)	2 Clearance (in mm)		3 Separation by Encapsulation (in mm)		4 Separation by Fixed Insulation (in mm)		5 Creepage Distance through Air (in mm)		6 Creepage Distance be- neath Protective Layer (in mm)		7 Comparative Tracking In- dex (CTI)	
	ia, ib	ic	ia, ib	ic	ia, ib	ic	ia, ib	ic	ia, ib	ic	ia	ib, ic
10	1.5	0.4	0.5	0.2	0.5	0.2	1.5	1.0	0.5	0.3	--	
30	2.0	0.8	0.7	0.2	0.5	0.2	2.0	1.3	0.7	0.3	100	100
60	3.0	0.8	1.0	0.3	0.5	0.3	3.0	1.9	1.0	0.6	100	100
90	4.0	0.8	1.3	0.3	0.7	0.3	4.0	2.1	1.3	0.6	100	100
190	5.0	1.5	1.7	0.6	0.8	0.6	8.0	2.5	2.6	1.1	175	175
375	6.0	2.5	2.0	0.6	1.0	0.6	10.0	4.0	3.3	1.7	175	175
550	7.0	4.0	2.4	0.8	1.2	0.8	15.0	6.3	5.0	2.4	275	175
750	8.0	5.0	2.7	0.9	1.4	0.9	18.0	10.0	6.0	2.9	275	175
1000	10.0	7.0	3.3	1.1	1.7	1.1	25.0	12.5	8.3	4.0	275	175
1300	14.0	8.0	4.6	1.7	2.3	1.7	36.0	13.0	12.0	5.8	275	175
1575	16.0	10.0	5.3	*	2.7	*	49.0	15.0	16.3	*	275	175
3.3k	*	18.0	9.0	*	4.5	*	*	32.0	*	*	*	*
4.7k	*	22.0	12.0	*	6.0	*	*	50.0	*	*	*	*
9.5k	*	45.0	20.0	*	10.0	*	*	100.0	*	*	*	*
15.6k	*	70.0	33.0	*	16.5	*	*	150.0	*	*	*	*

Note 1: \*At present, no values have been recommended for these voltages.

Note 2: Proof of fulfillment of the CTI requirements for the insulating materials must be provided by the manufacturer. Defining a CTI is not required for insulation materials for voltage levels up to 10 V.

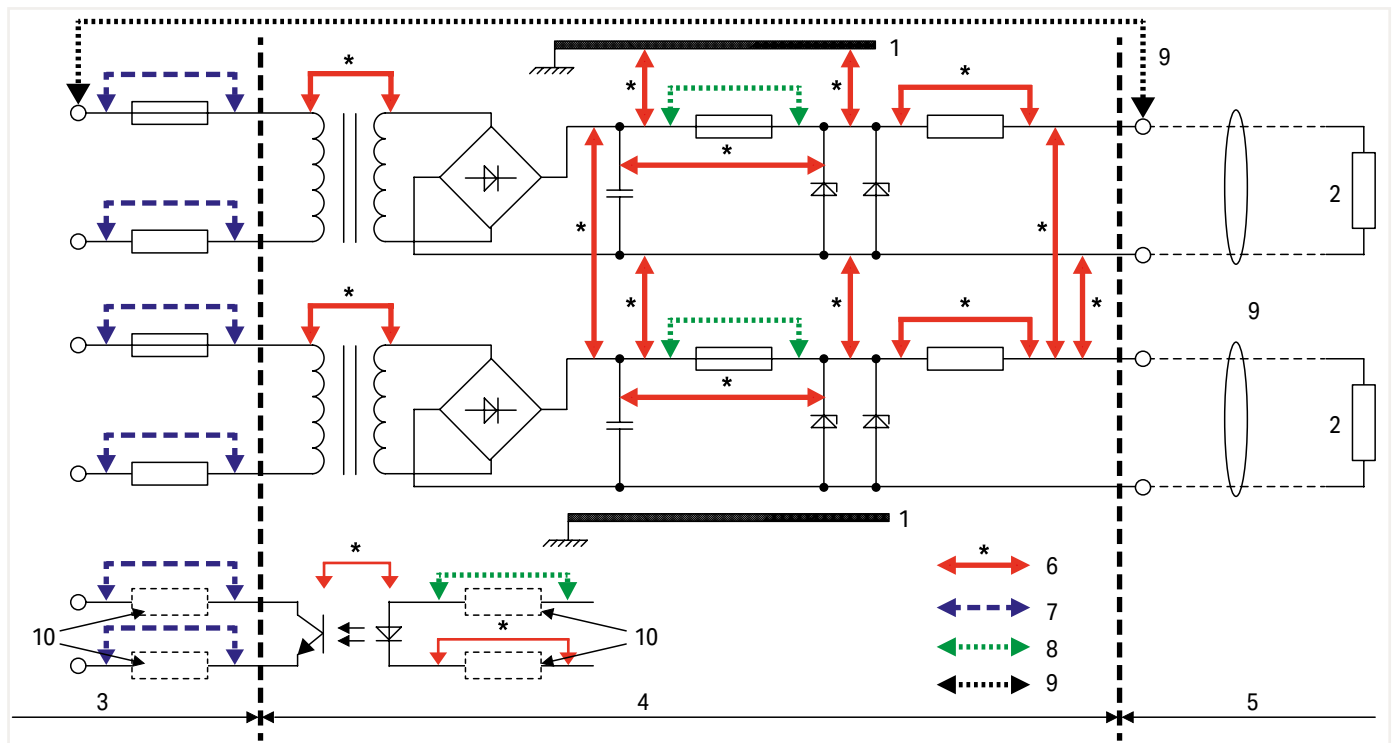

Figure 2: Isolation examples for conductive parts

**Legend:**

- 1 Chassis
- 2 Load
- 3 Non-intrinsically safe circuit defined by  $U_m$
- 4 Portion of intrinsically safe circuit, item is not intrinsically safe
- 5 Intrinsically safe circuit
- 6 Dimensions for which Table 5 applies
- 7 Dimensions for which general industrial standards apply
- 8 Dimensions per 7.3
- 9 Dimensions based on 6.2.1 for output terminal blocks between isolated intrinsically safe circuits ( $d_2 \geq 6 \text{ mm}$ ) and between intrinsically safe circuits and non-intrinsically safe circuits ( $d_3 \geq 50 \text{ mm}$ )
- 10 Where required

























In accordance with DIN EN 60079-14 (VDE 0165-1), in intrinsically safe circuits, the ends of stranded and fine-stranded conductors must be protected against splaying (e.g., via cable lugs or ferrules) or by the type of terminal blocks used. Soldering alone is not sufficient.











The conductor entry funnels of WAGO PCB terminal blocks fulfill this requirement.

WAGO recommends gas-tight tinned copper ferrules or tinned copper pin terminals when connecting fine-stranded conductors to terminal blocks in corrosive atmospheres.



## International Certification Organizations – Overview

		Abbreviation			Abbreviation
	Underwriters Laboratories USA <a href="http://www.ul.com">http://www.ul.com</a>	UL		Danmarks Elektriske Materielkontrol Denmark <a href="http://www.demko.dk">http://www.demko.dk</a>	DEMKO
	Underwriters Laboratories USA <a href="http://www.ul.com">http://www.ul.com</a>	UL		CENELEC CERTIFICATION AGREEMENT Danmarks Elektriske Materielkontrol Denmark <a href="http://www.cenelec.org">http://www.cenelec.org</a>	CCA Zul.-Nr. mit NL
	Underwriters Laboratories USA <a href="http://www.ul.com">http://www.ul.com</a>	cURus			
	Underwriters Laboratories USA <a href="http://www.ul.com">http://www.ul.com</a>	cULus		SETI – FEMKO Sähkötarastuskeskus Elinspektioncentralen Finland <a href="http://www.seti.fi">http://www.seti.fi</a>	
	Canadian Standards Association Canada <a href="http://www.csa.ca">http://www.csa.ca</a>	CSA		Sähkötarastuskeskus Elinspektioncentralen Finland <a href="http://www.fimko.com">http://www.fimko.com</a>	FIMKO
	VDE-Gutachten mit Fertigungsüberwachung Germany <a href="http://www.vde.de/vde/html/e/home.htm">http://www.vde.de/vde/html/e/home.htm</a>	VDE		South African Bureau of Standards South Africa <a href="http://www.sabs.co.za">http://www.sabs.co.za</a>	SABS
	VDE – Deutscher Verband für Elektrotechnik Germany <a href="http://www.vde.de">http://www.vde.de</a>			RosTeST Russia <a href="http://www.rostest.ru">http://www.rostest.ru</a>	ROTEST
VDE	VDE – Prüfbericht Germany			Departamentul Moldovastandard Moldova <a href="http://www.moldova.md/ro/government/oil/D_STAND/en/strcent2.htm">http://www.moldova.md/ro/government/oil/D_STAND/en/strcent2.htm</a>	CSM
	Österreichischer Verband für Elektrotechnik Austria <a href="http://www.ove.at">http://www.ove.at</a>	ÖVE		Certificate of Registration Great Britain <a href="http://www.astacertification.com">http://www.astacertification.com</a>	ASTA
	Schweizerischer Elektrotechnischer Verein Switzerland <a href="http://www.sev.ch/">http://www.sev.ch/</a>	SEV		Rheinisch-Westfälischer Technischer Überwachungsverein e.V. Germany <a href="http://www.rwtuv.de">http://www.rwtuv.de</a>	RWTÜV
	N.V. tot Keuring van Elektrotechnische Materialen Netherlands <a href="http://www.kema.nl">http://www.kema.nl</a>	KEMA		Elektrotechnický výskumný a projektový ústav Czech Republic <a href="http://www.ezu.cz">http://www.ezu.cz</a>	EZU
CCA	CENELEC CERTIFICATION AGREEMENT N.V. tot Keuring van Elektrotechnische Materialen Netherlands <a href="http://www.cenelec.org">http://www.cenelec.org</a>	CCA Zul.-Nr. mit NL		Stowarzyszenie Elektryków Polskich Poland <a href="http://www.sep.com.pl">http://www.sep.com.pl</a>	BBJ
	Norges Elektriske Materialkontroll Norway <a href="http://express.nemko.com">http://express.nemko.com</a>	NEMKO		Stowarzyszenie Elektryków Polskich Poland <a href="http://www.bbj.pl">http://www.bbj.pl</a>	SEP
	Svenska Elektriska Materielkontrollanstalten AB Sweden <a href="http://www.semko.com">http://www.semko.com</a>	SEMKO			

		Abbreviation			Abbreviation
<b>CNET</b>	Centre National d'Etudes des Télécommunications France <a href="http://www.lannion.cnet.fr">http://www.lannion.cnet.fr</a>	CNET		Robbanásbiztos Villamos Berendezések Hungary <a href="http://www.bki.hu">http://www.bki.hu</a>	BKI
<b>LCIE</b>	Laboratoire Central des Industries Electriques France <a href="http://www.lcie.fr">http://www.lcie.fr</a>	LCIE	CB	CB – TEST CERTIFICATE India <a href="http://www.ul-europe.com">http://www.ul-europe.com</a>	CB
	Fyzikální Technický Ústav, Ostrava-Radvanice Czech Republic <a href="http://www.ftzu.cz">http://www.ftzu.cz</a>	FTZU	CB	CB – TEST CERTIFICATE China <a href="http://www.ul-europe.com">http://www.ul-europe.com</a>	CB
				<a href="http://www.enec.com">http://www.enec.com</a>	ENEC
<b>Marine Approvals</b>			<b>EX Approvals</b>		
<b>BV</b>	Bureau Veritas France <a href="http://www.bureauveritas.fr">http://www.bureauveritas.fr</a>	BV		Physikalisch Technische Bundesanstalt Germany <a href="http://www.ptb.de">http://www.ptb.de</a>	PTB
	Lloyd's Register of Shipping Great Britain <a href="http://www.lloydsregister.com">http://www.lloydsregister.com</a>	LR		Underwriters Laboratories USA <a href="http://www.ul.com">http://www.ul.com</a>	AEx
	NV – Det Norske Veritas Norway <a href="http://www.dnvgl.com">http://www.dnvgl.com</a>	DNV-GL			
	Russian Maritime Register of Shipping GUS <a href="http://www.rs-head.spb.ru">http://www.rs-head.spb.ru</a>	RMR			
	Polski Rejestr Statków Poland <a href="http://www.prs.pl">http://www.prs.pl</a>	PRS			
	Korean Register of Shipping Korea <a href="http://www.krs.co.kr">http://www.krs.co.kr</a>	KR			
<b>ABS</b>	American Bureau of Shipping USA <a href="http://www.eagle.org">http://www.eagle.org</a>	ABS			

## Electrical Engineering Laboratory Product Safety for Our Customers

To use terminal blocks globally, they must satisfy certain standards and obtain test certificates. These requirements apply to every manufacturer. WAGO also conducts its own tests to increase standards and offer greater reliability with its products. Products undergo a full range of mechanical, electrical and climatic testing, and we'll share a few of those processes with you.

### Pull-Out Test (per EN 60947-7-1, EN 60998-2-2)

During the pull-out force test, a conductor is pulled on until it is removed from the clamping unit. The design of the terminals means that extraction only occurs after the standard pull-out force has been exceeded many times over.

### WAGO Test Lab

This means that WAGO's products can be used safely and reliably both in Europe and anywhere globally for a wide variety of applications. We heavily emphasize the importance of global acceptance during development. As a result, we can present documentation that verifies our high levels of product safety and reliability while ensuring the fulfillment and accuracy of technical data, which are the highest priorities for our customers and users worldwide. On December 22, 2009, our test lab was accredited by the German Accreditation Association (Deutsche Gesellschaft für Akkreditierung GmbH) in accordance with DIN EN ISO/IEC 17025.



### Vibration Test (per IEC/EN 60068-2-6)

Depending on the application, such as railway (per EN 61373) or marine (per GL, LR, DNV), there are various testing requirements to determine if the long-term effects of vibrations degrade electrical connections. The test specimen is subjected to different loads on three axes in an electrodynamic vibration system. The amplitude, the acceleration, and particularly the frequency of the vibration vary during the test. The test values are increased many times over the standard values to meet special customer requirements.

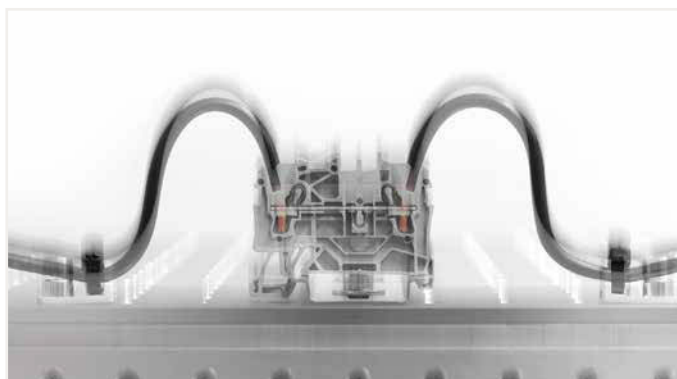

### Shock Test (per IEC/EN 60068-2-27)

The shock test is very similar to the vibration test except that, instead of continuous vibrations, single shocks are applied to the test specimen. Shock tests are usually performed, for example, at an acceleration of 20g over a period of 11 ms. Tests for special requirements often call for much higher values and are also conducted in our laboratory. Single-deck TOPJOB® S Rail-Mount Terminal Blocks, for example, pass shock tests up to 500g.



### Voltage Drop Test under Bending Stress (per EN 60947-7-1, EN 60999-1)

The voltage drop test under bending stress simulates mechanical stress on the clamping unit. In everyday use, this stress can occur during installation, for example, when an electrician shoves connected conductors to the side in order to access a specific component. The quality of the clamping unit when moving a connected conductor can be validated by the constantly stable measured value of the voltage drop.





## Deutsche Akkreditierungsstelle GmbH

**Beliehene gemäß § 8 Absatz 1 AkkStelleG i.V.m. § 1 Absatz 1 AkkStelleGBV**  
Unterzeichnerin der Multilateralen Abkommen  
von EA, ILAC und IAF zur gegenseitigen Anerkennung

# Akkreditierung



Die Deutsche Akkreditierungsstelle GmbH bestätigt hiermit, dass das Prüflaboratorium

**WAGO Kontakttechnik GmbH & Co. KG**  
**Hansastraße 27, 32423 Minden**

die Kompetenz nach DIN EN ISO/IEC 17025:2005 besitzt, Prüfungen in folgenden Bereichen durchzuführen:

**Elektrische und mechanische Prüfungen an Klemmen und Steckverbinder  
sowie Umweltsimulation**

Die Akkreditierungsurkunde gilt nur in Verbindung mit dem Bescheid vom 18.12.2014 mit der Akkreditierungsnummer D-PL-19704-01 und ist gültig bis 17.12.2019. Sie besteht aus diesem Deckblatt, der Rückseite des Deckblatts und der folgenden Anlage mit insgesamt 5 Seiten.

Registrierungsnummer der Urkunde: **D-PL-19704-01-00**

Frankfurt am Main, 18.12.2014

  
Im Auftrag Dipl.-Ing. (FH) Ralf Egner  
Abteilungsleiter

Siehe Hinweise auf der Rückseite

## WAGO-Seminars

### Learn Today – Benefit Tomorrow

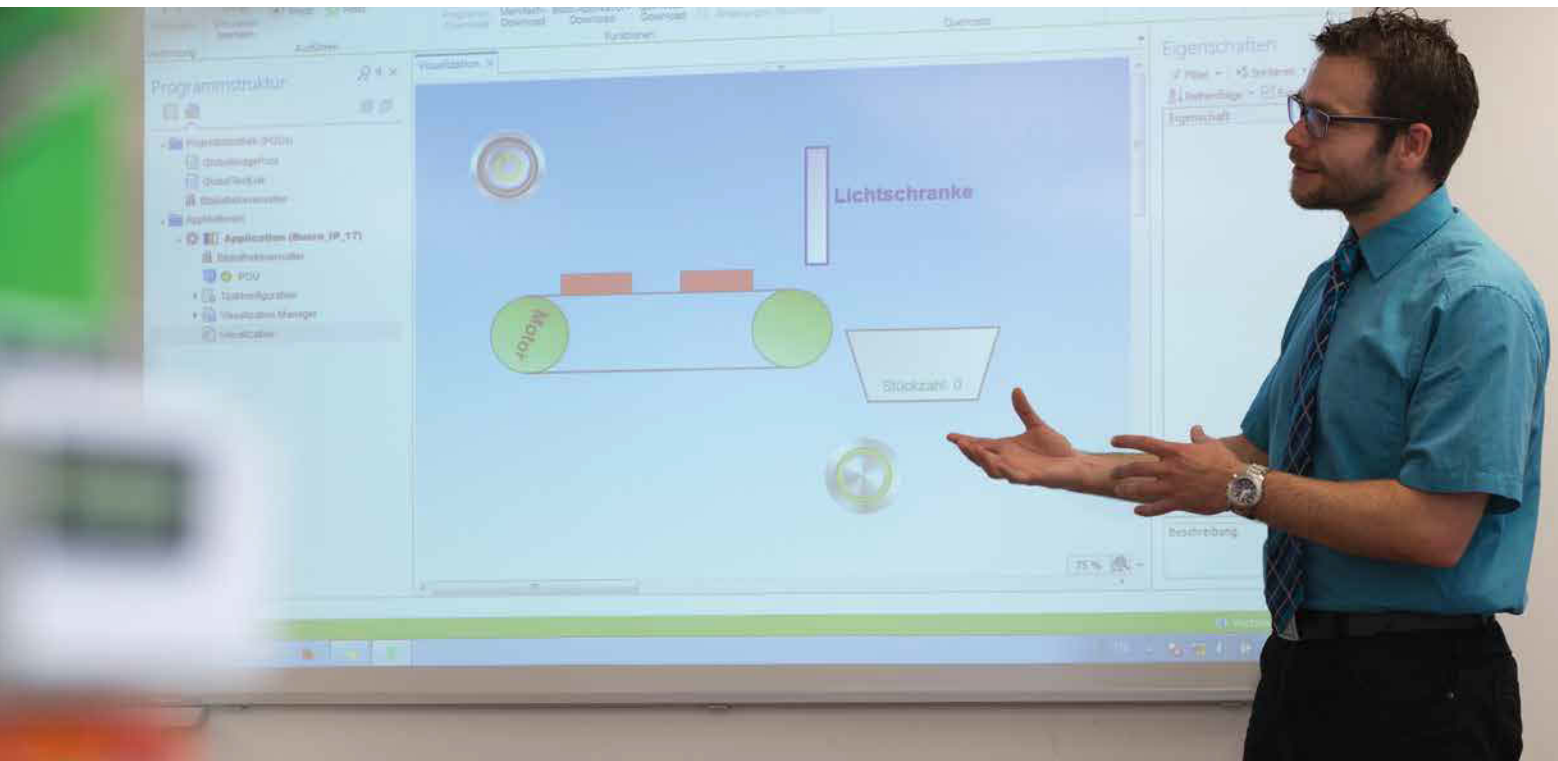

## Setting the Bar with Your Goals

### Product-Related and Customer-Specific Seminars



#### Small Groups

The small class sizes of WAGO training seminars ensures that no question goes unanswered and no one is overlooked.



#### Teamwork

Learning as a group is very effective. Ideas can be discussed and exchanged while experiences can be shared – all for the benefit of the participants.



#### Practical Topics

Experience has shown that practice makes perfect. This is why the focus of every WAGO training seminar is on practical, hands-on learning.



## WAGO-Seminars

Experience the Benefits of First-Hand Knowledge and Expertise – Straight from the Source

Our instructors are specialists who know all the ins and outs of WAGO's products. This ensures that the time devoted to each WAGO training seminar is an effective investment in expanding your own expertise.

Request your registration form by email:  
[training@wago.com](mailto:training@wago.com)

Contact your local  
**WAGO office.**

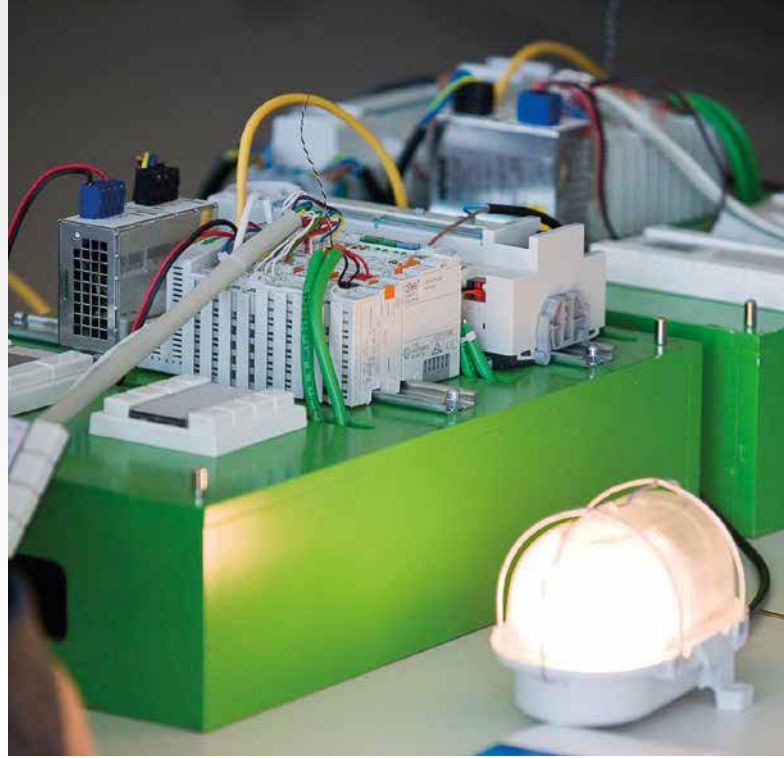

### Product-Related Seminars

We regularly offer product-related seminars on the following topics:

- Building and industrial automation
- Programming of automation components
- Fieldbus systems

**Current Seminars at:**  
[www.wago.com](http://www.wago.com)

### Customer-Specific Training Seminars

In addition to these "open" seminars, we also offer seminars specially tailored to your organization and its particular needs.

Upon request, we can also conduct these courses at your location.

**Special  
 Corporate Seminars**